

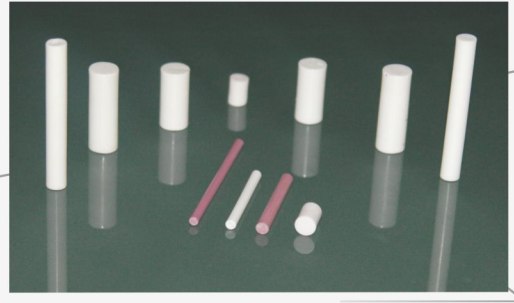

EK.09

ÇUBUK KILAVUZLAR RODE GUIDES

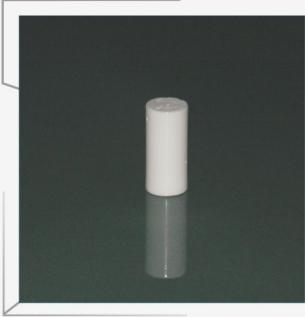



KOD NO	ØD	L
EK.09.158	1,5	9,2
EK.09.114	1,5	20
EK.09.115	2	18,5
EK.09.130	2	20
EK.09.131	2,4	22,2
EK.09.153	2,5	18,1
EK.09.186	2,7	80
EK.09.138	2,8	50
EK.09.150	3	3
EK.09.101	3	10
EK.09.112	3	15
EK.09.157	3	18
EK.09.111	3	30,5
EK.09.185	3	56
EK.09.206	3	185
EK.09.178	3,1	37,8
EK.09.179	3,1	85,6
EK.09.192	3,2	38,7
EK.09.160	3,2	46,2
EK.09.164	3,4	45,7
EK.09.155	3,6	35,6
EK.09.102	3,8	19,5

KOD NO	ØD	L
EK.09.103	3,8	32
EK.09.163	3,8	49,5
EK.09.104	3,8	66
EK.09.183	4	21
EK.09.105	4	44,8
EK.09.137	4,5	15
EK.09.113	4,5	51,4
EK.09.152	4,7	38,1
EK.09.142	4,8	60
EK.09.159	4,8	95,7
EK.09.125	4,9	20
EK.09.126	4,9	40
EK.09.176	4,9	50,1
EK.09.144	5	8,5
EK.09.194	5	12
EK.09.199	5	12
EK.09.175	5	40
EK.09.196	5	45
EK.09.197	5,5	60
EK.09.129	5,8	60
EK.09.198	6	12
EK.09.200	6	20

KOD NO	ØD	L
EK.09.133	6	30
EK.09.201	6	30
EK.09.174	6	31,8
EK.09.170	6	34,7
EK.09.106	6	80,4
EK.09.149	6,2	39,6
EK.09.107	6,3	47,3
EK.09.204	6,4	63
EK.09.195	7	15
EK.09.181	7,5	210
EK.09.108	7,6	46,8
EK.09.202	7,7	35
EK.09.166	7,9	26
EK.09.165	7,9	35
EK.09.188	7,9	70,9
EK.09.147	7,9	108
EK.09.189	7,9	122,2
EK.09.203	7,9	160
EK.09.128 A	8	12
EK.09.128 B	8	15
EK.09.134 A	8	12
EK.09.134 B	8	20

KOD NO	ØD	L
EK.09.134 C	8	30
EK.09.205	8	51,5
EK.09.109	8	60
EK.09.180	8	90
EK.09.191	9,5	76,2
EK.09.207	9,5	136
EK.09.208	10	20
EK.09.209	10	160
EK.09.123	11	240
EK.09.117	11,7	120
EK.09.110	11,8	17,9
EK.09.127	11,8	45
EK.09.171	12	12
EK.09.172	12	25
EK.09.169	12	35
EK.09.182	14	54
EK.09.210	15	35
EK.09.212	15	135
EK.09.116	19,3	124

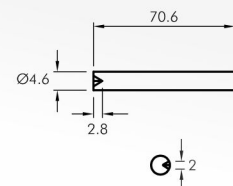
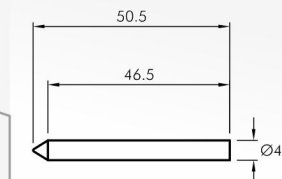
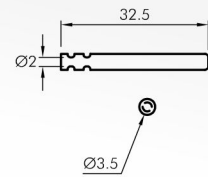
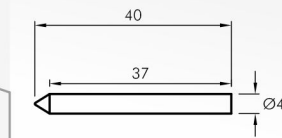

EK 09.122

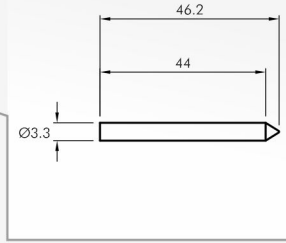
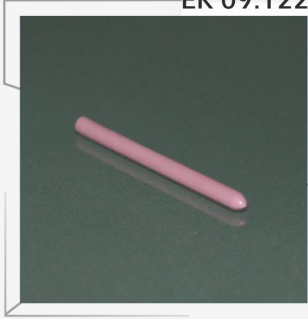

EK 09.124

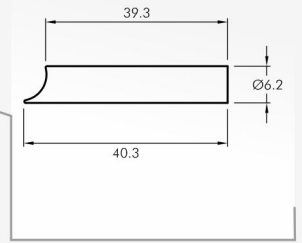
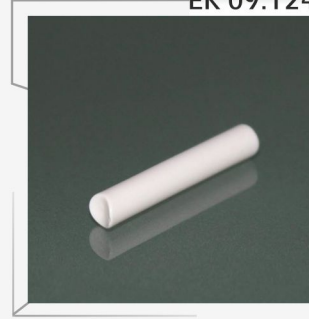

EK 09.132

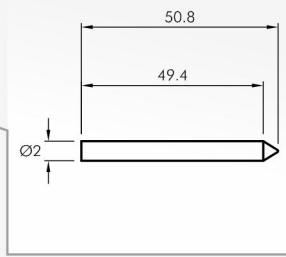
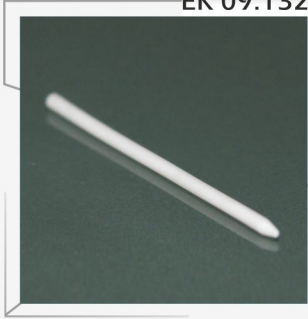

EK-09.135 ZR

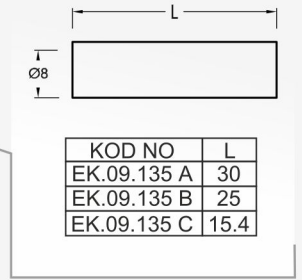

EK-09.136 ZR

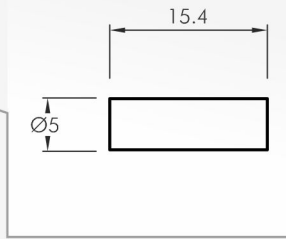

EK 09.139

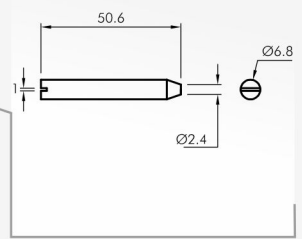
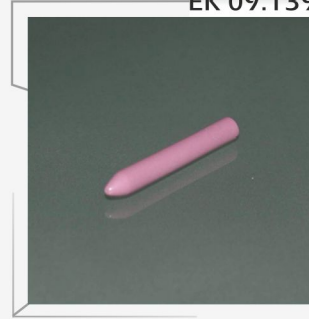

EK 09.140

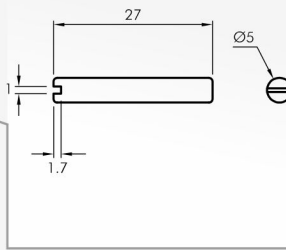
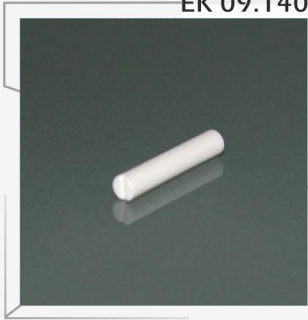

EK 09.141

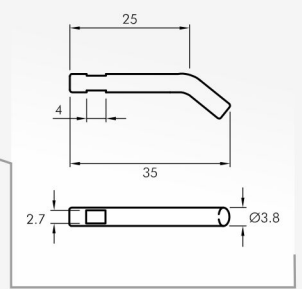
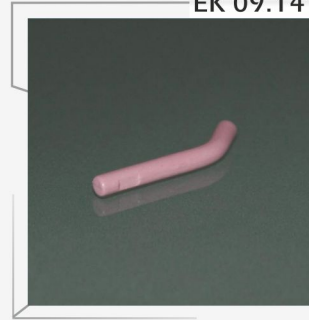

EK 09.143

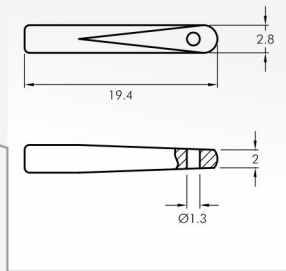
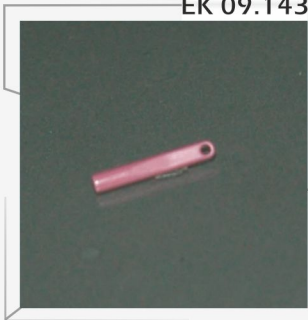

EK 09.145

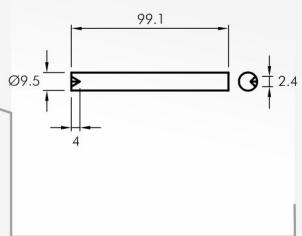

EK.09

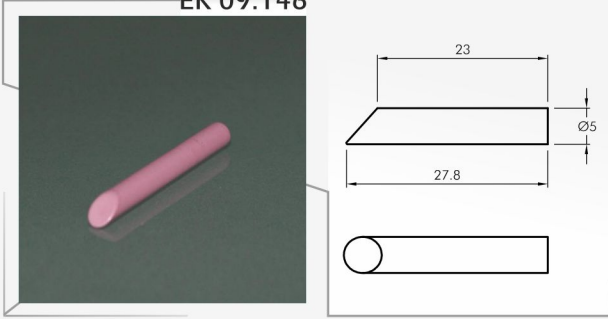
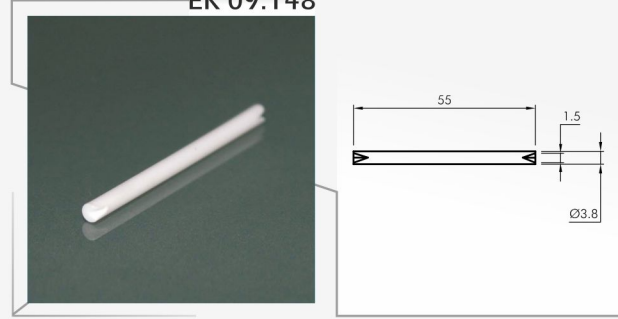
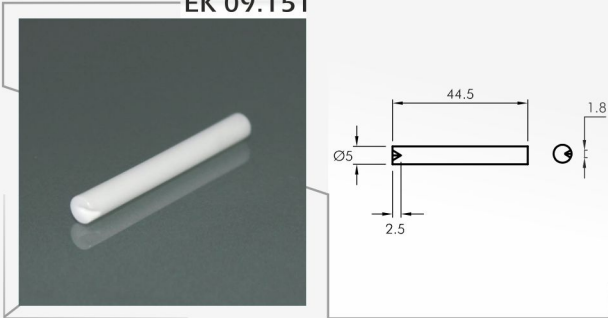
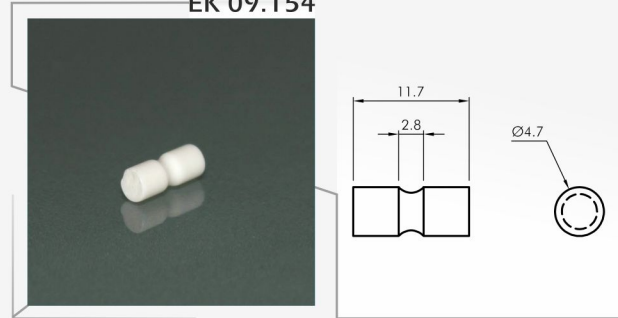
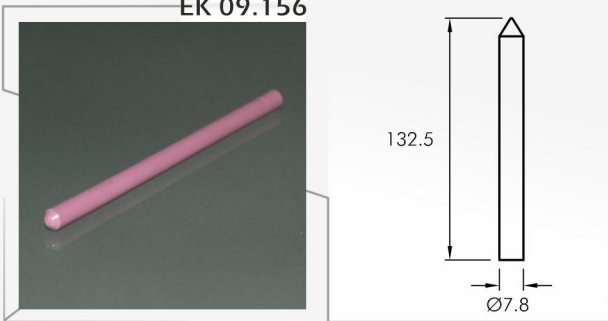
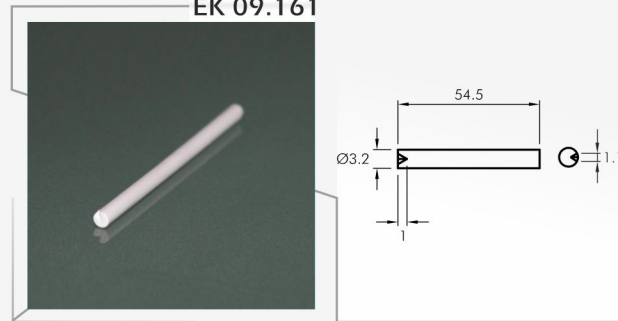
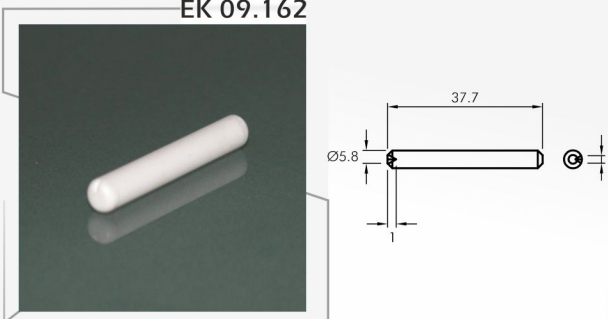
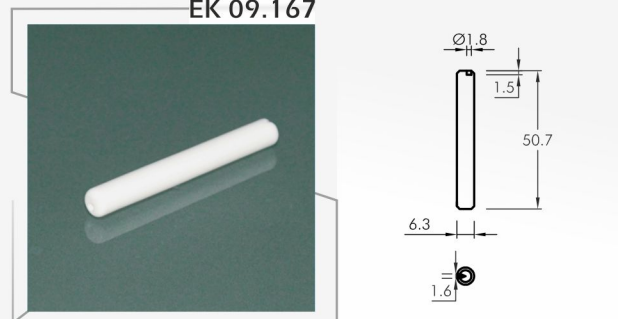
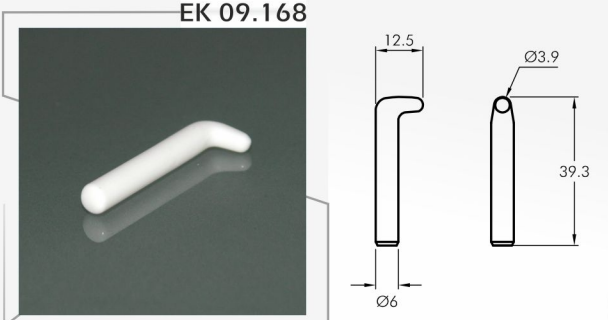
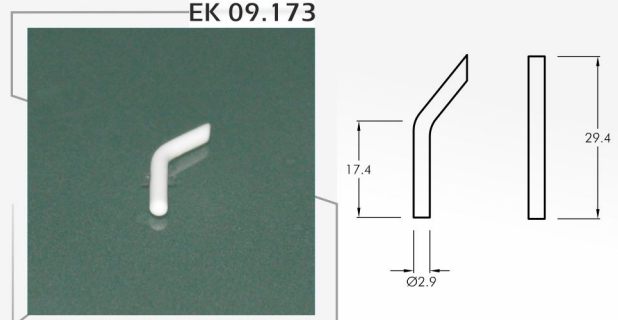
EK 09.146

EK 09.148

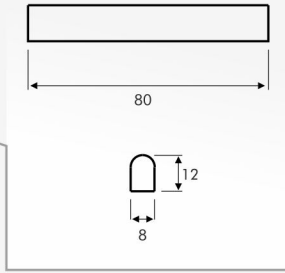
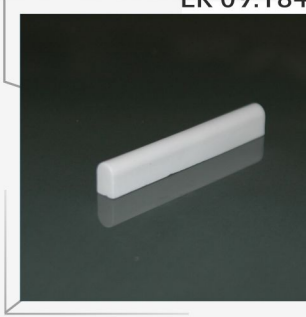
EK 09.151

EK 09.154

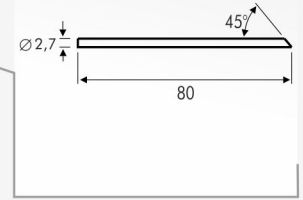
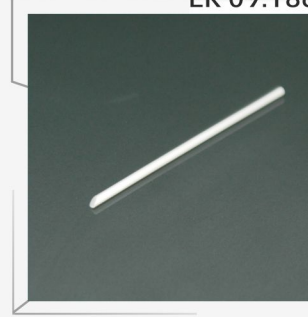
EK 09.156

EK 09.161

EK 09.162

EK 09.167

EK 09.168

EK 09.173

EK 09.184



EK 09.186



EK 09.187

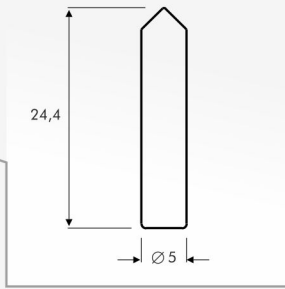

EK 09.190

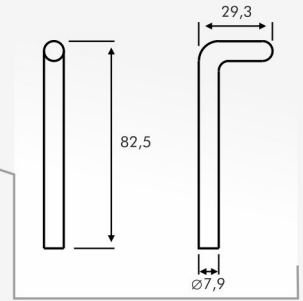
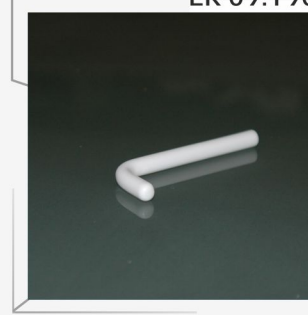

EK 09.193

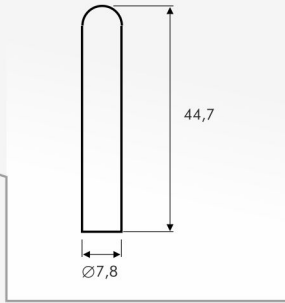
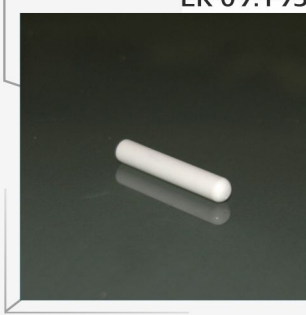

EK 09.211

