



EK.05

“U” KILAVUZLAR

“U” GUIDES



EK 05.101

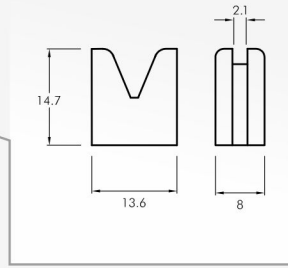
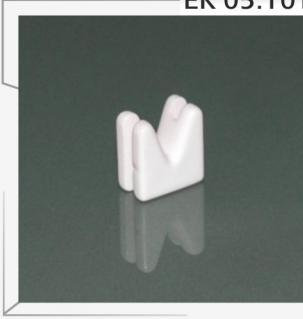

EK 05.102

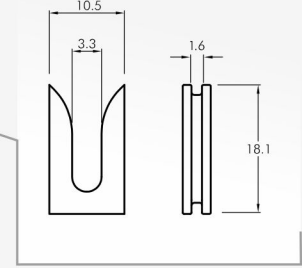
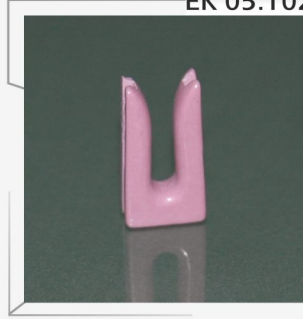

EK 05.103

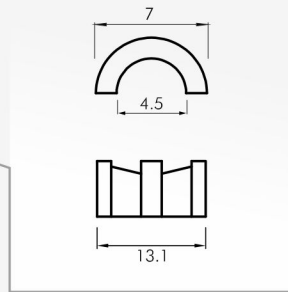

EK 05.104

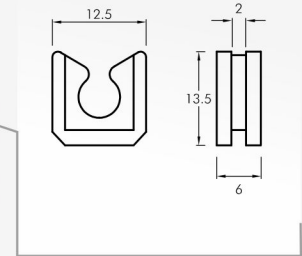

EK 05.105

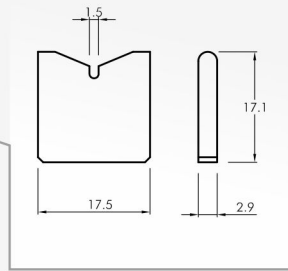
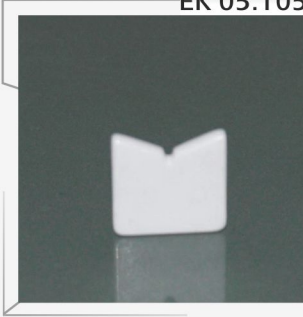

EK 05.106

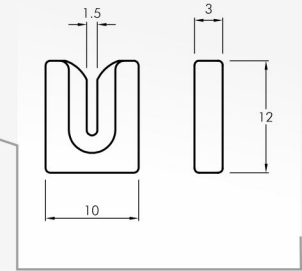
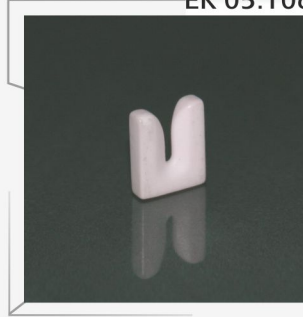

EK 05.107

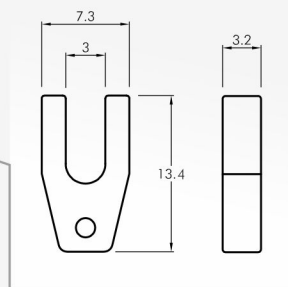
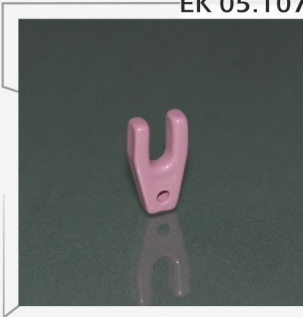

EK 05.108

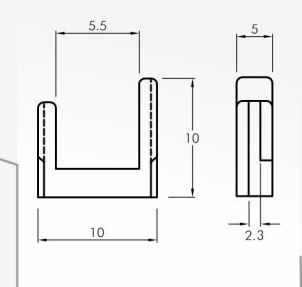

EK 05.109

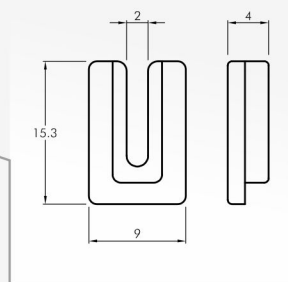
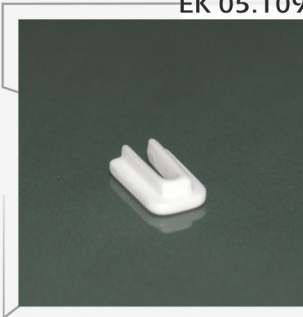

EK 05.110

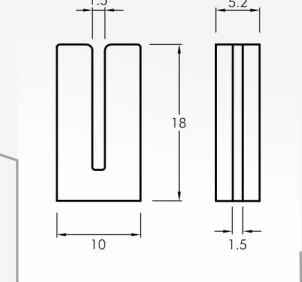
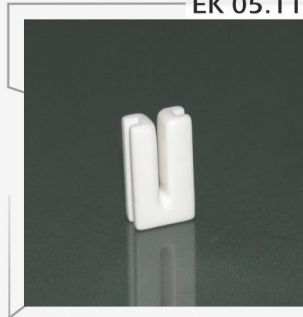

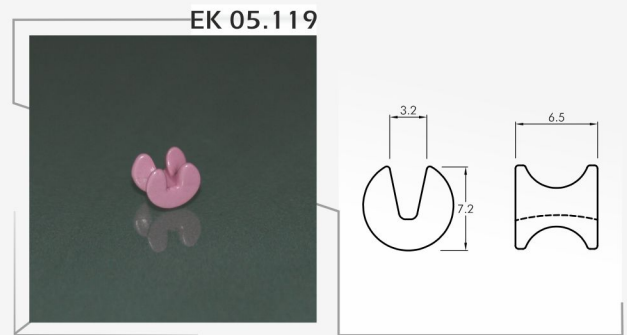
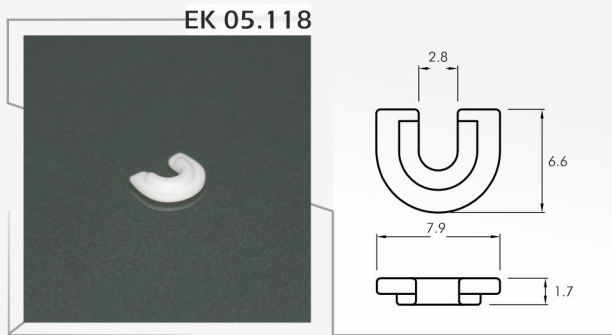
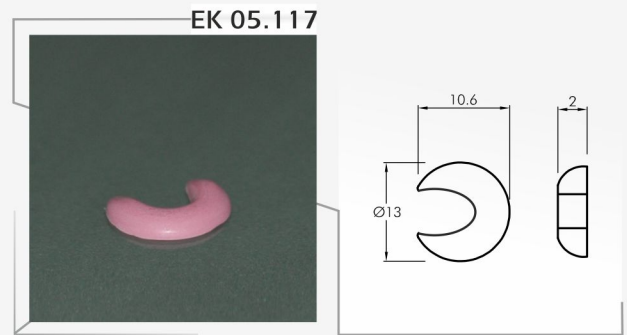
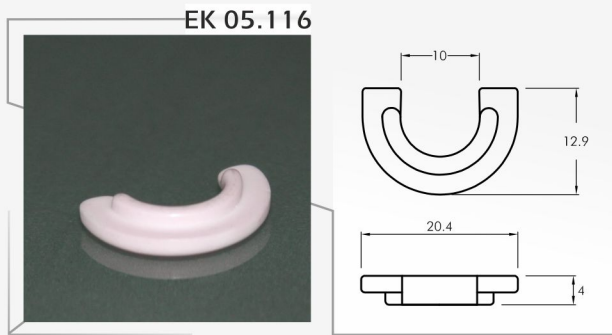
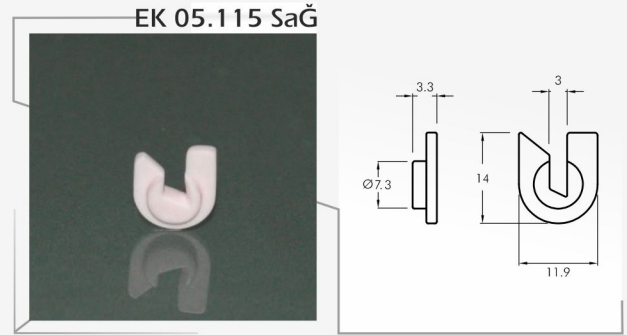
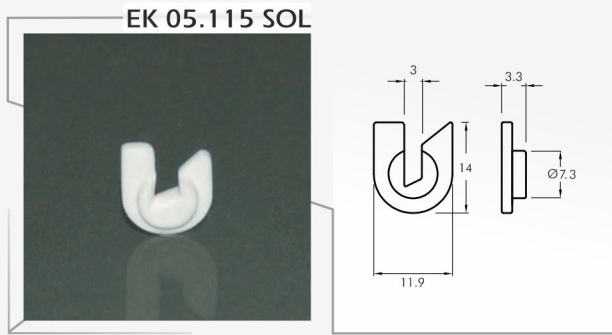
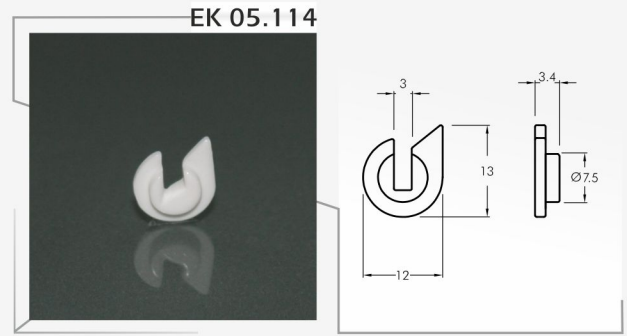
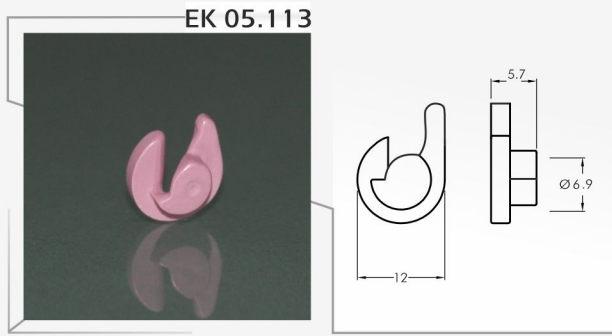
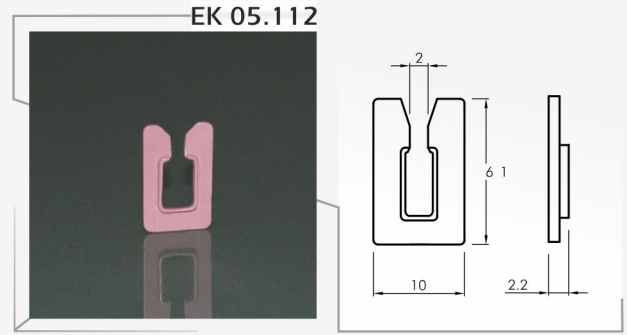
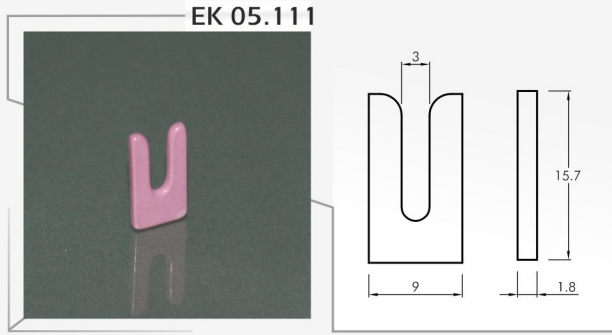

EK 05.120

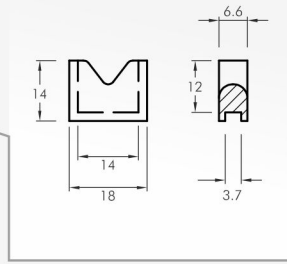
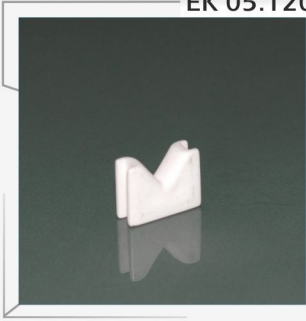

EK 05.121

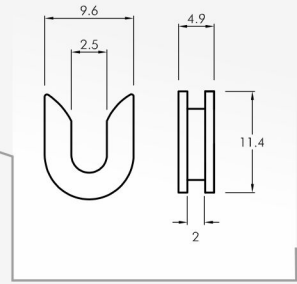

EK 05.122

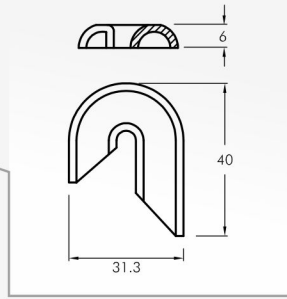
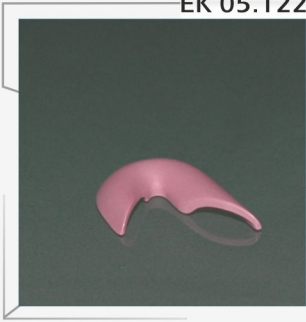

EK 05.124

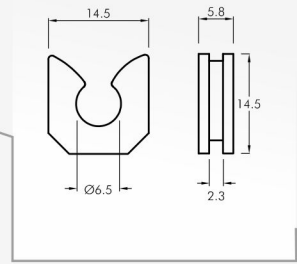
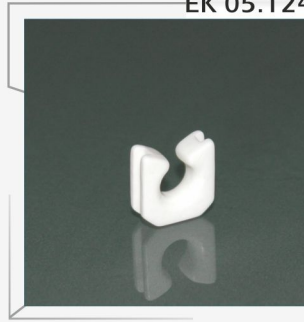

EK 05.125

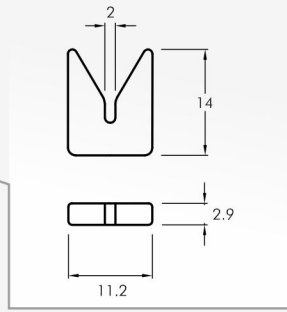
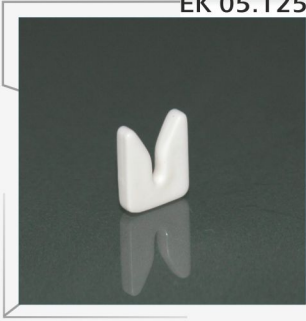

EK 05.126

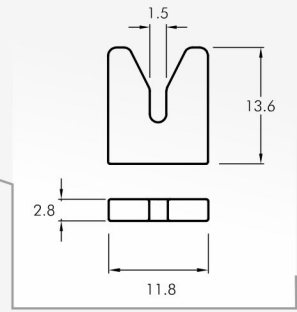
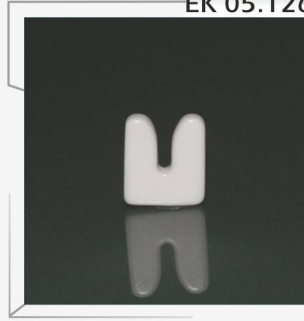

EK 05.127

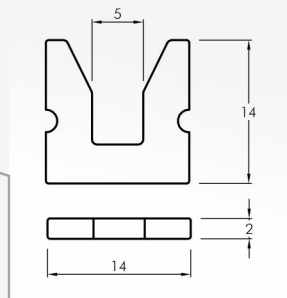
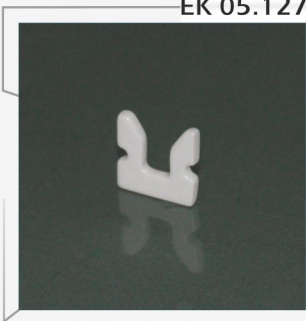

EK 05.128

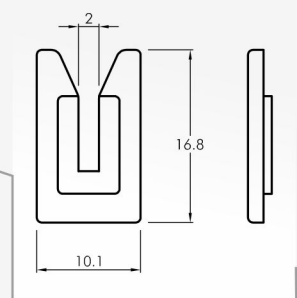

EK 05.129

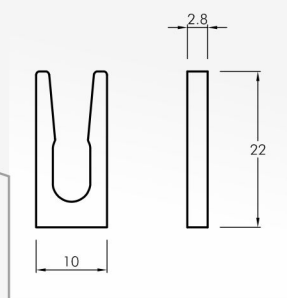
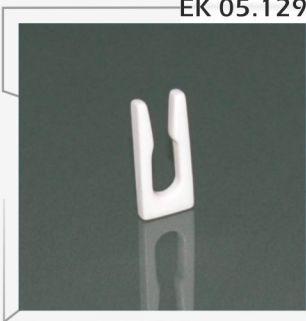

EK 05.130

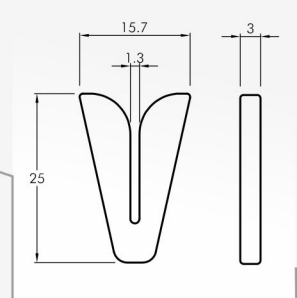
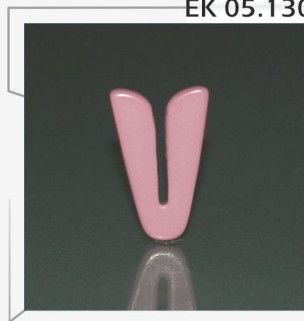

EK 05.131

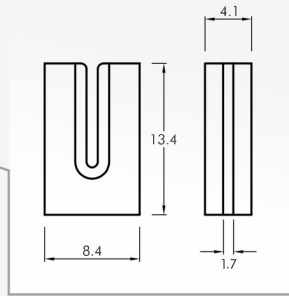
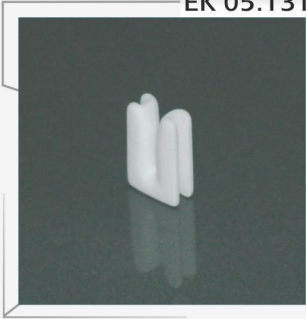

EK 05.132

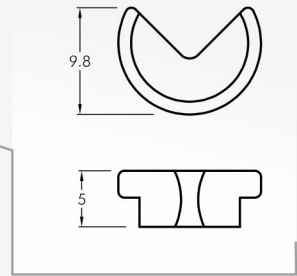
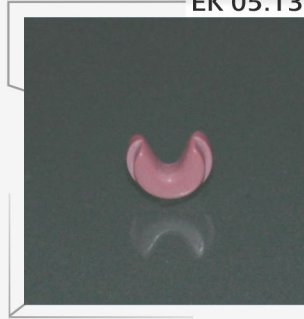

EK 05.133

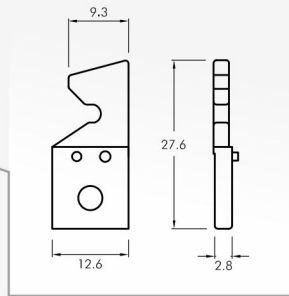

EK 05.134

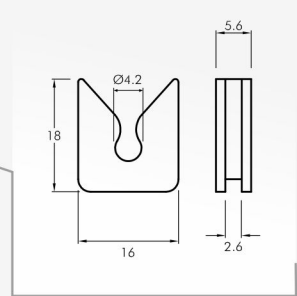

EK 05.135

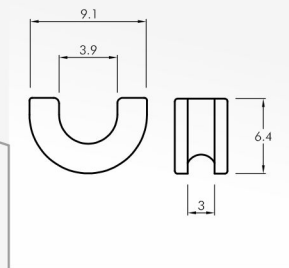
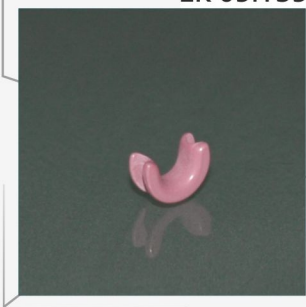

EK 05.136

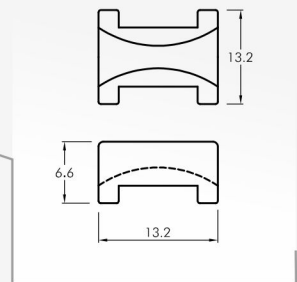

EK 05.137

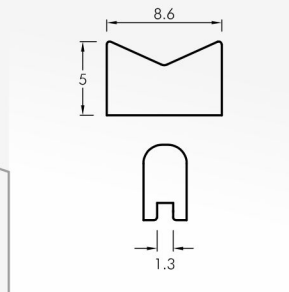

EK 05.138

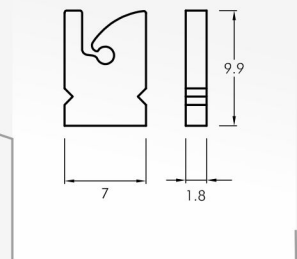

EK 05.139

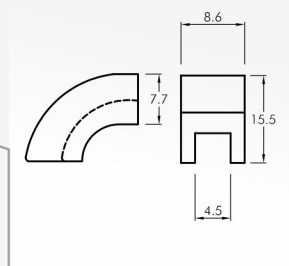

EK 05.140

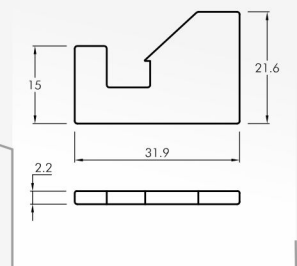
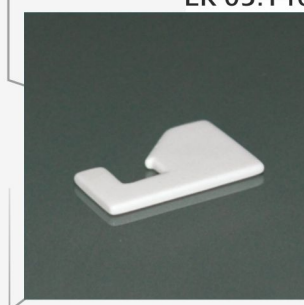

EK 05.141

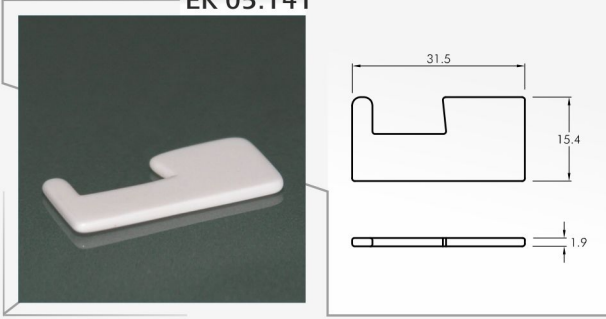

EK 05.142

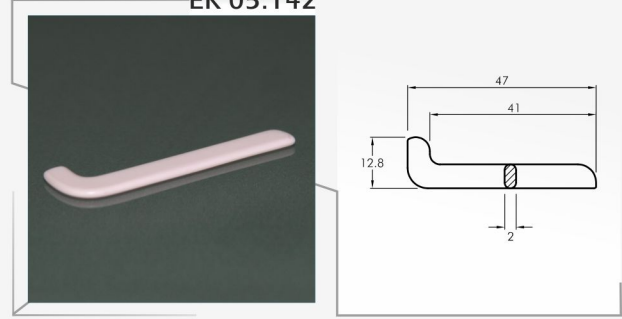

EK 05.143

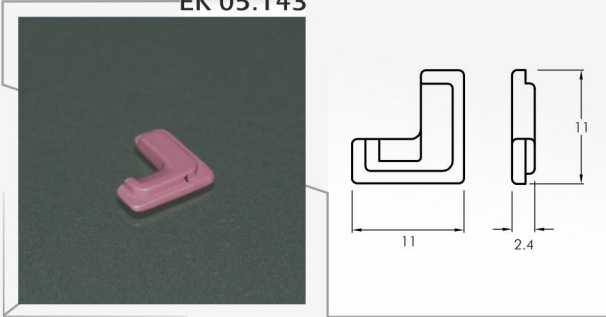

EK 05.144

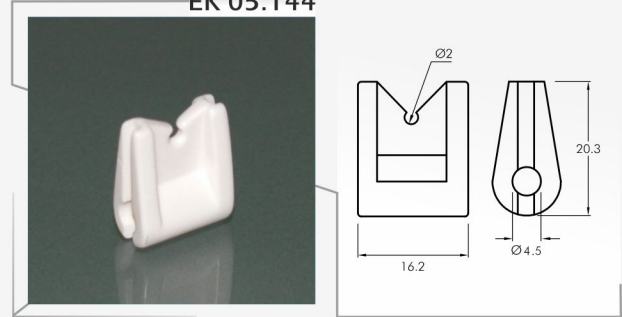

EK 05.145

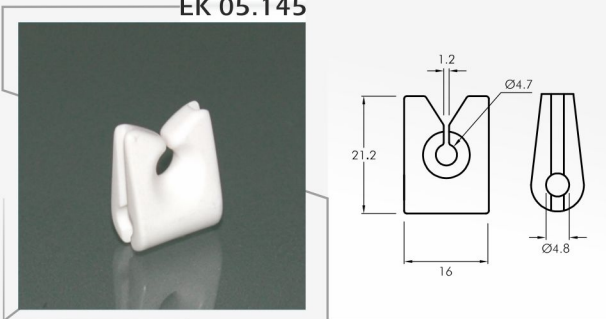

EK 05.146

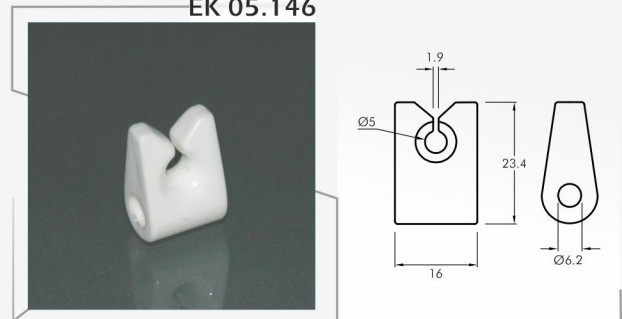

EK 05.147

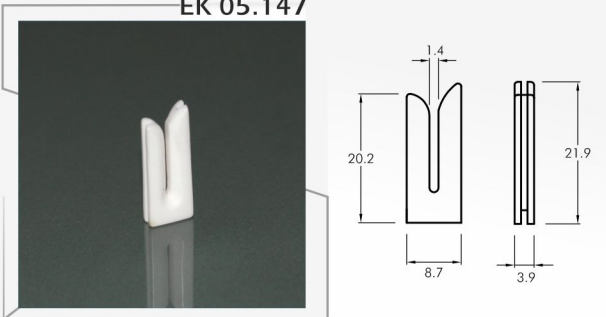

EK 05.148

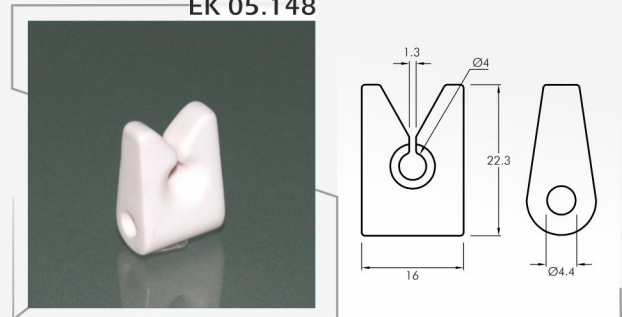

EK 05.149

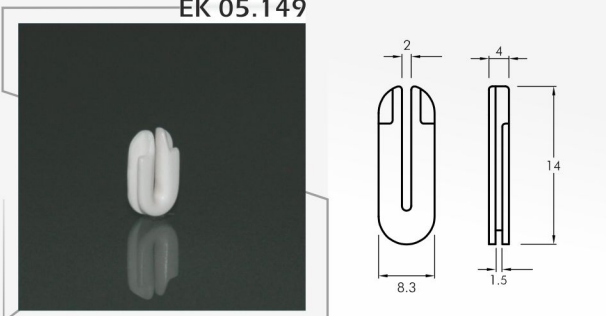

EK 05.150

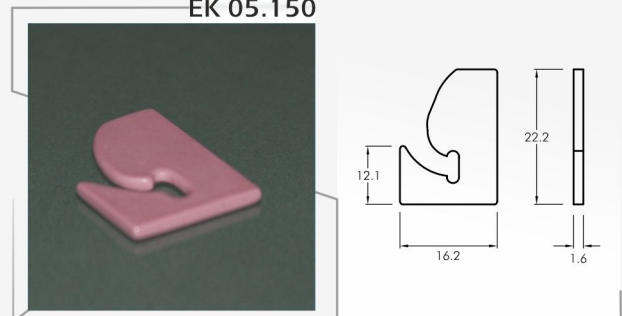

EK 05.151

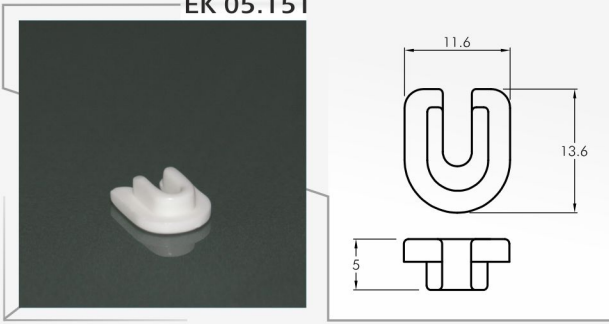

EK 05.152

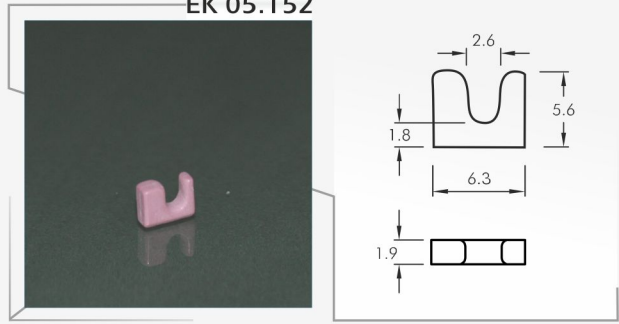

EK 05.153

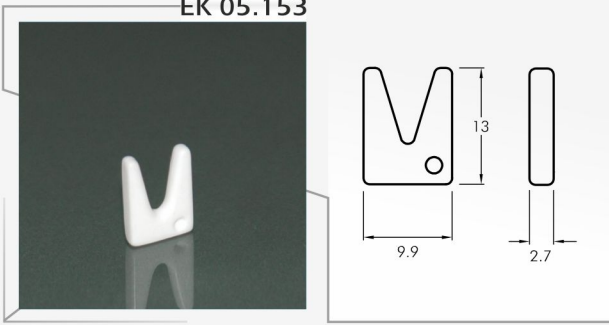

EK 05.154

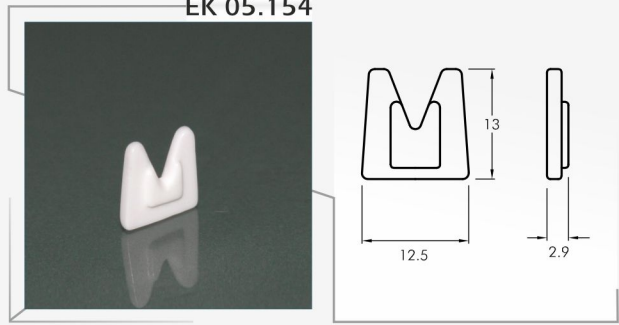

EK 05.155

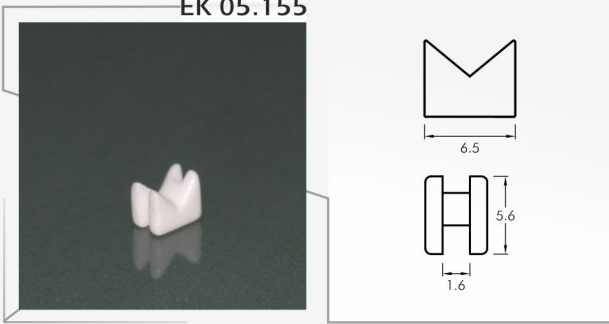

EK 05.156

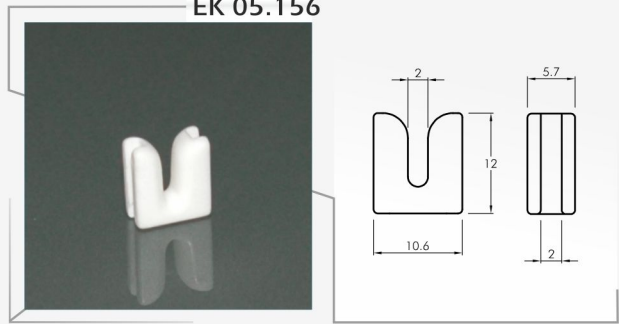

EK 05.157

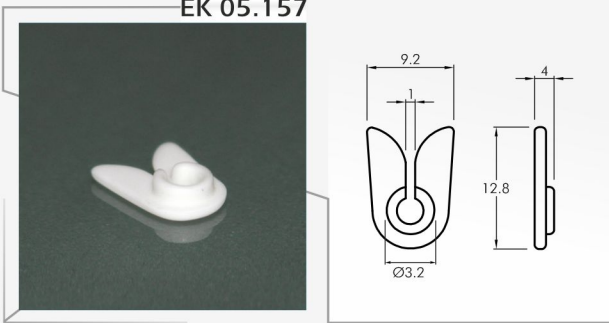

EK 05.158

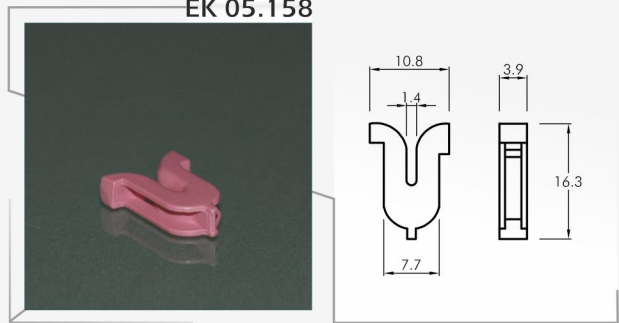

EK 05.159

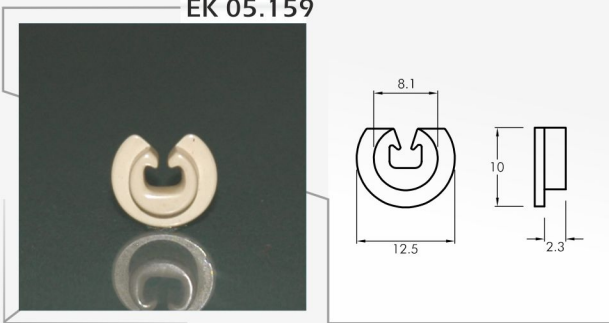

EK 05.160

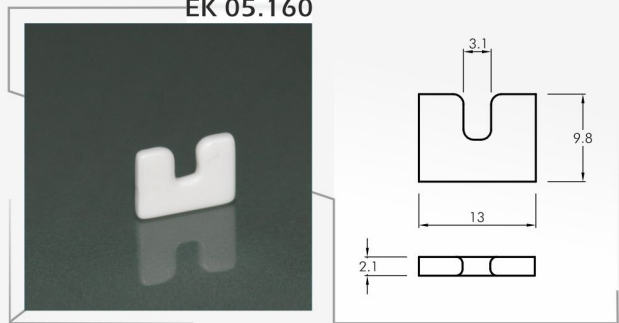

EK.05

EK 05.161

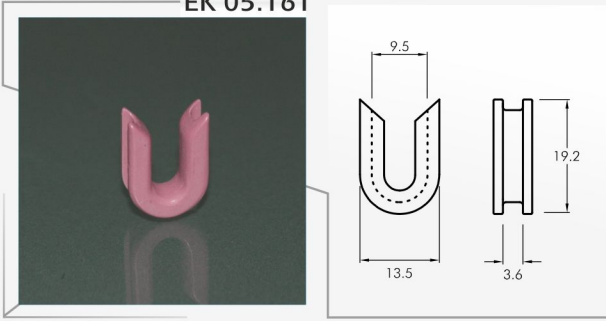

EK 05.162

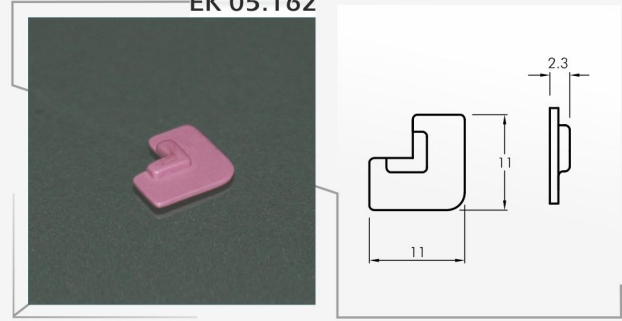

EK 05.163

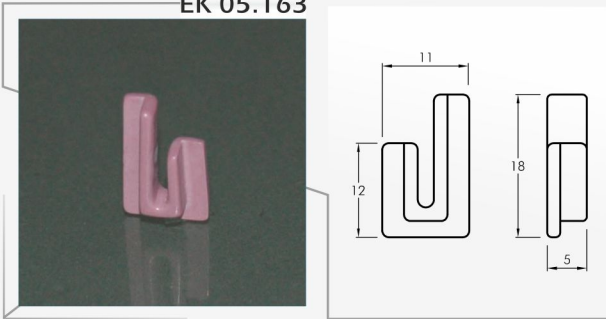

EK 05.165

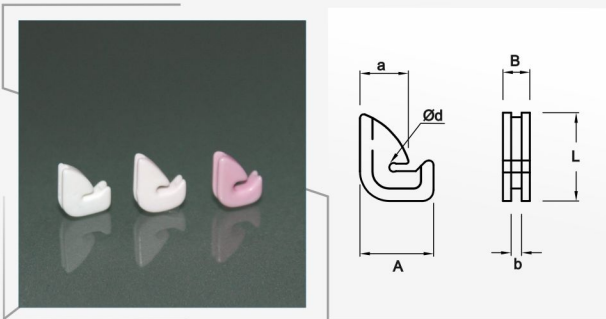
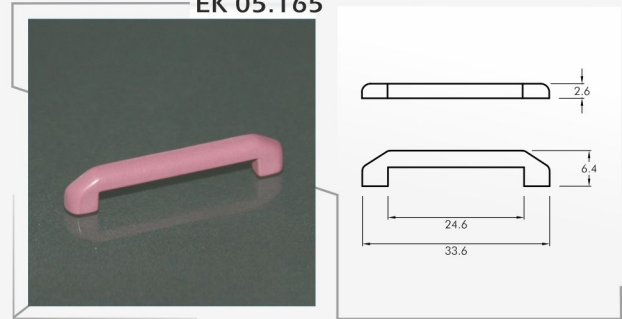

KOD NO	A	a	B	b	L	Ød
EK.05.164	10	6.6	3.3	1.3	11.9	1
EK.05.321	9.6	6.5	3.6	1.4	12.2	2.2
EK.05.322	9.8	6.8	3.6	1.4	12.2	0.8
EK.05.406	10	6.8	3.3	1	12.5	1.5

EK 05.166

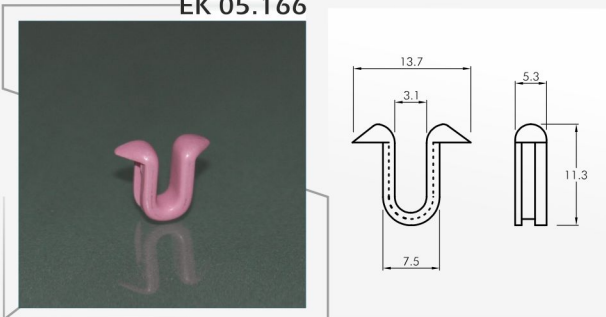

EK 05.167

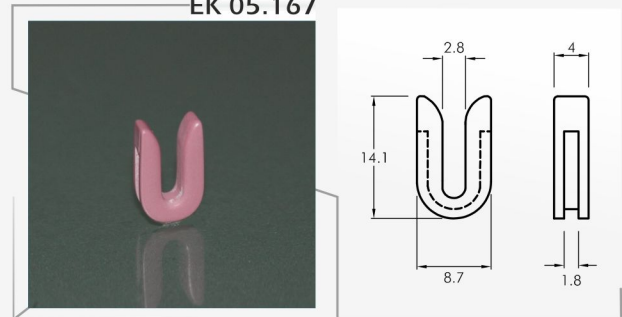

EK 05.168

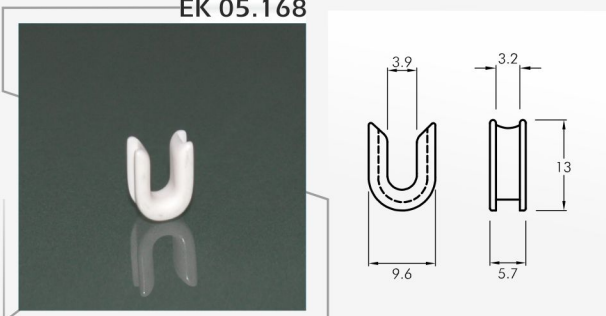

EK 05.169

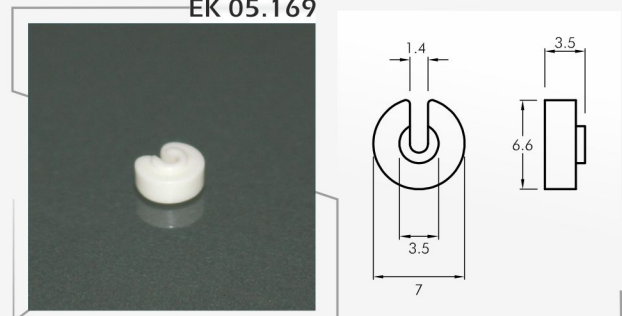

EK 05.170

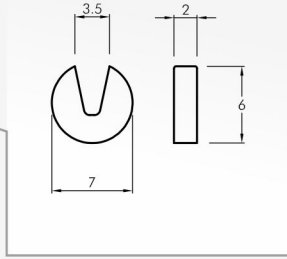
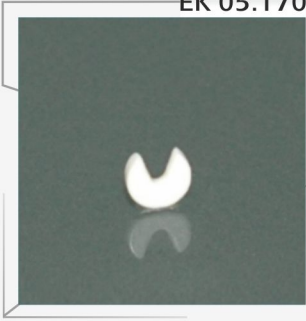

EK 05.171

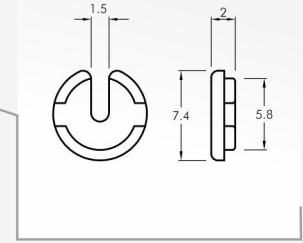

EK 05.172

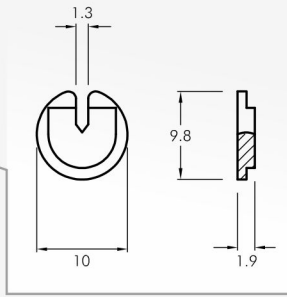
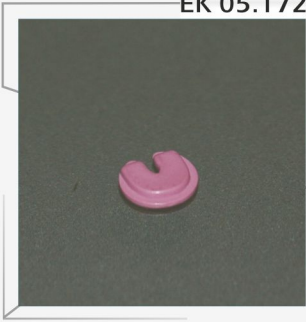

EK 05.173

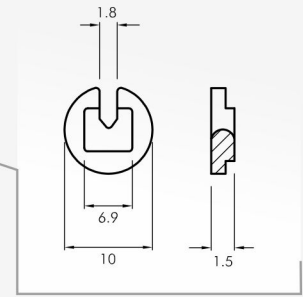
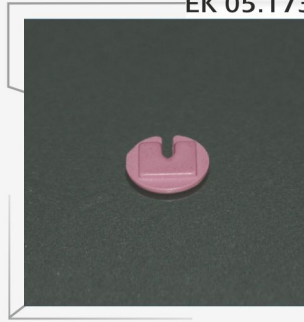

EK 05.174

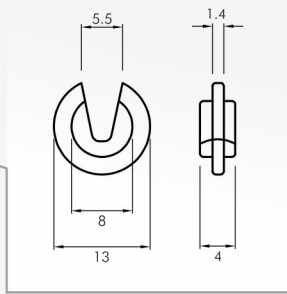
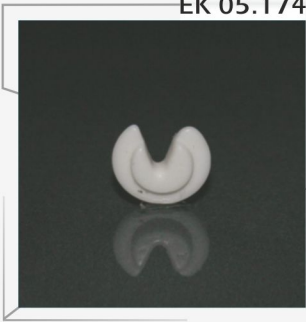

EK 05.175

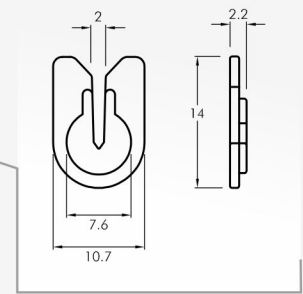

EK 05.176

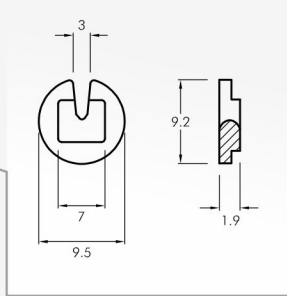

EK 05.177

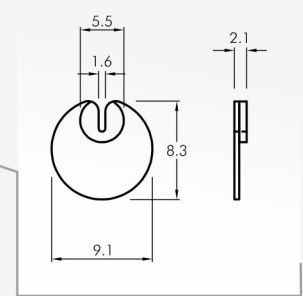
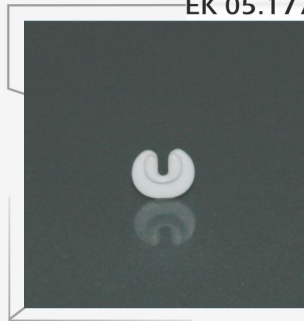

EK 05.178

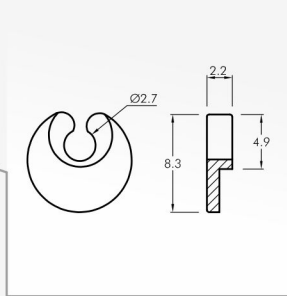

EK 05.179

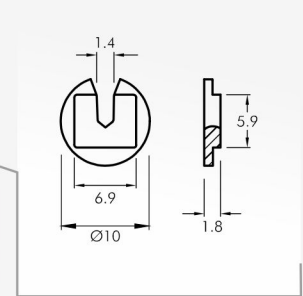
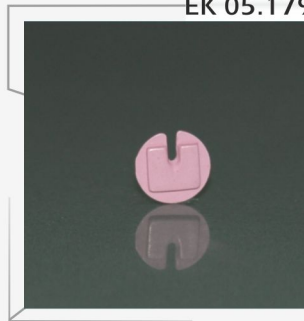

EK 05.180

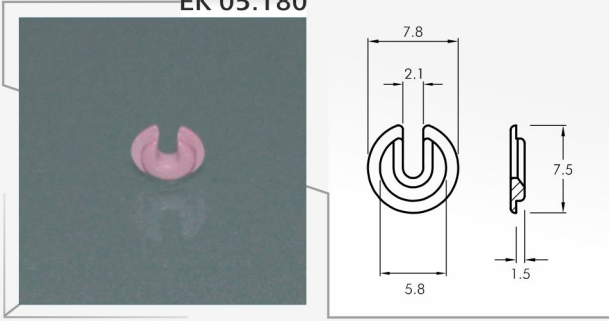

EK 05.181

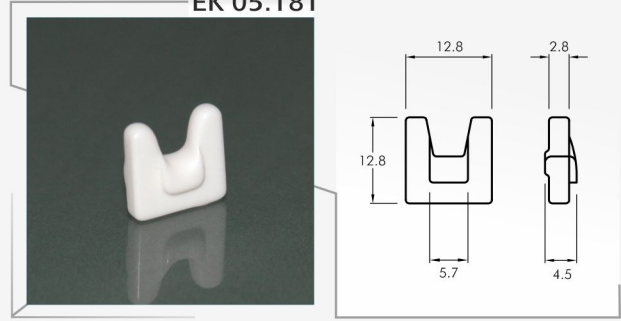

EK 05.182

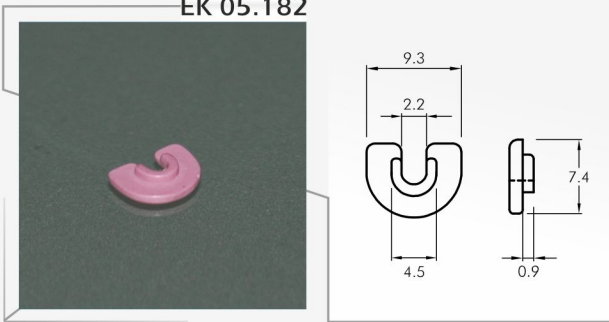

EK 05.183

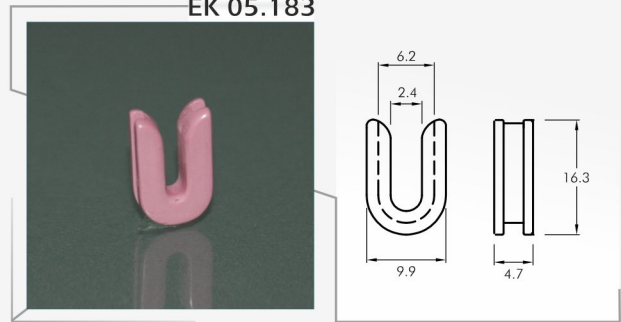

EK 05.184

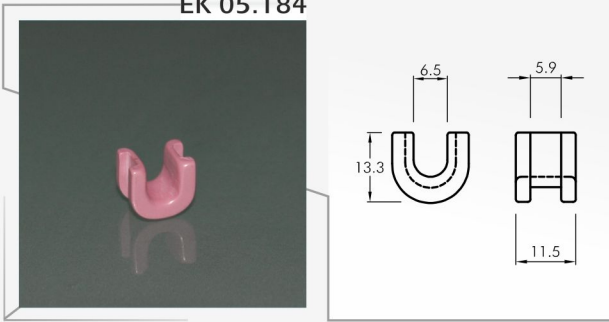

EK 05.185

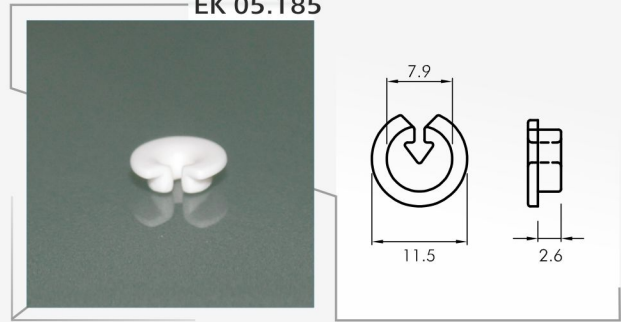

EK 05.186

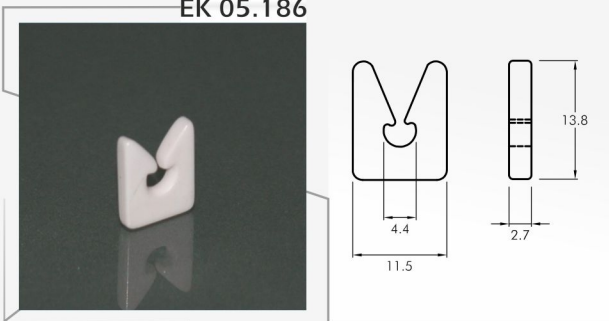

EK 05.187

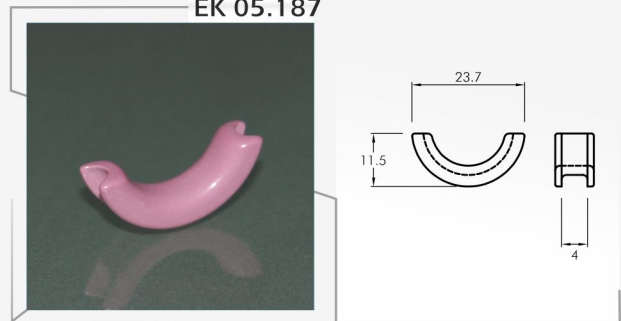

EK 05.188

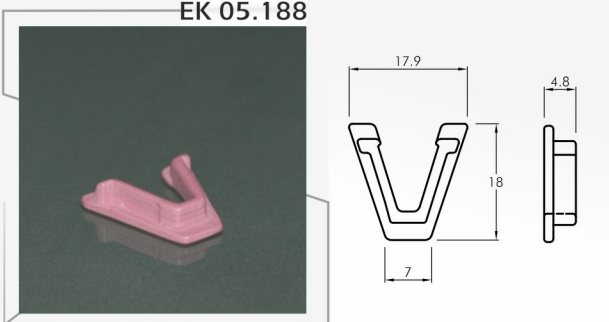

EK 05.189

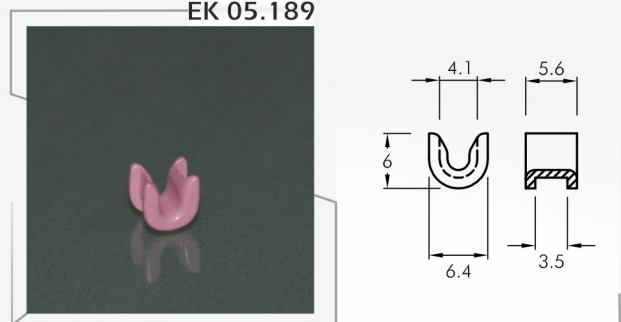

EK 05.190

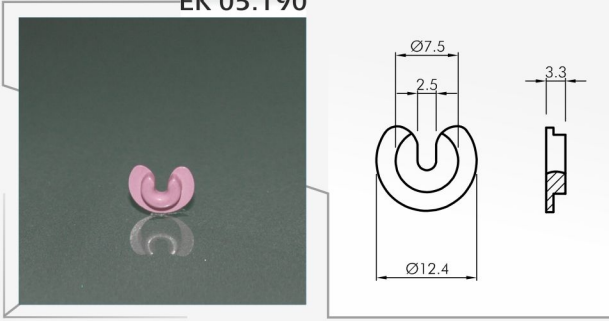

EK 05.191

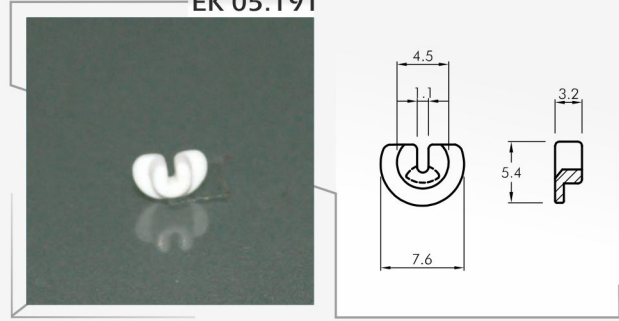

EK 05.192

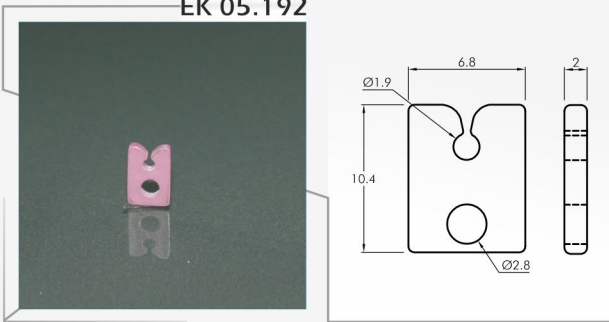

EK 05.193

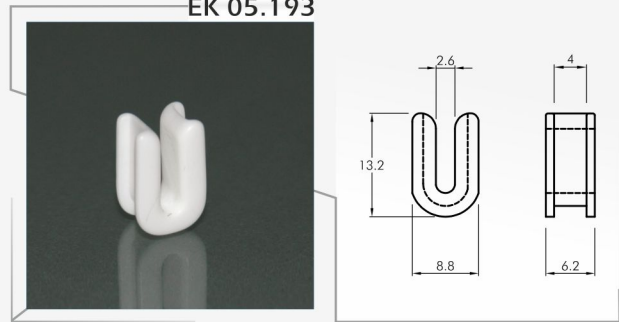

EK 05.194

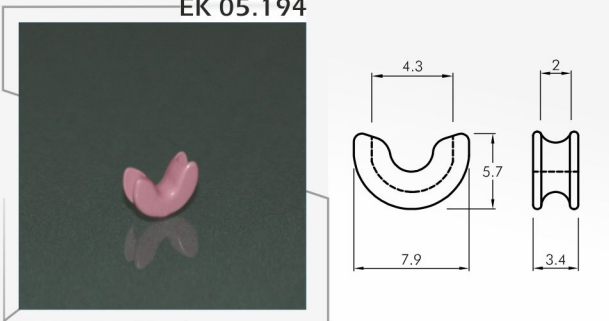

EK 05.195

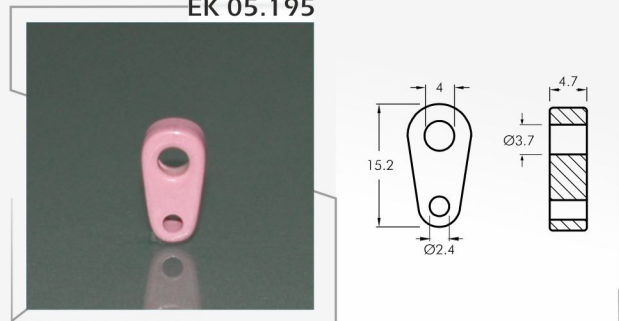

EK 05.196

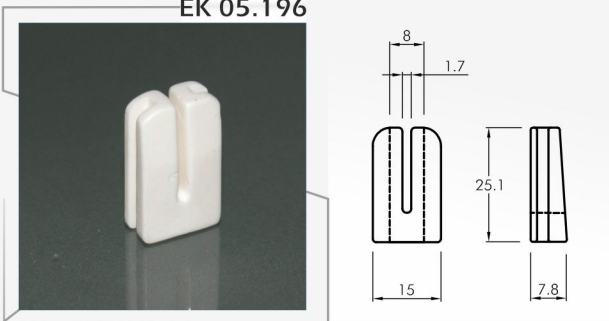

EK 05.197

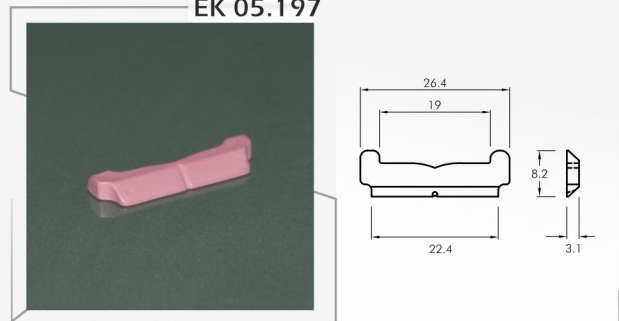

EK 05.198

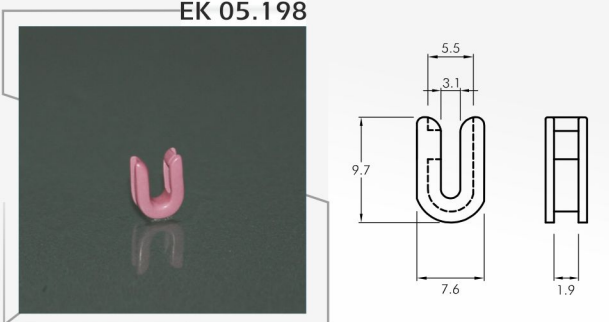

EK 05.199

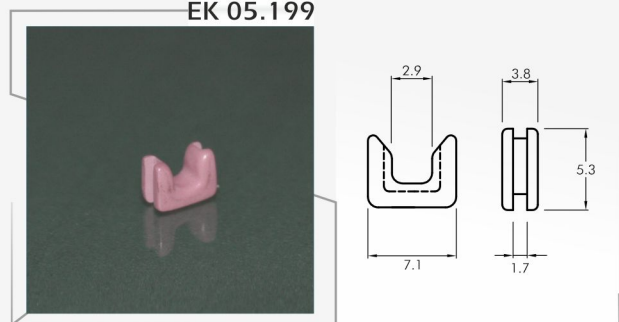



EK 05.200

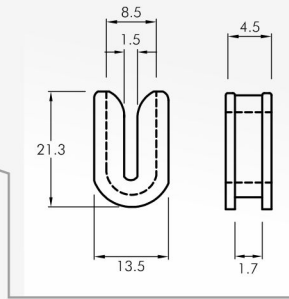
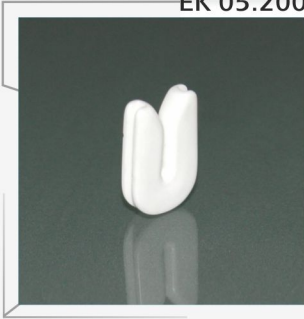

EK 05.212

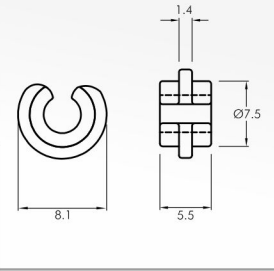

EK 05.219

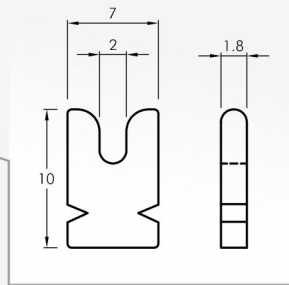
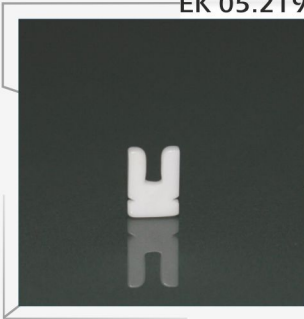

EK 05.232

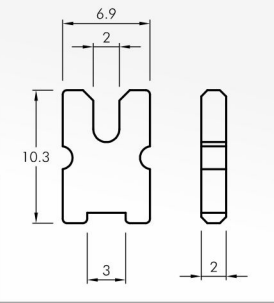
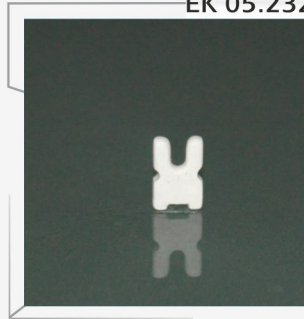

EK 05.222

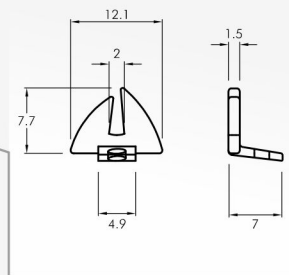
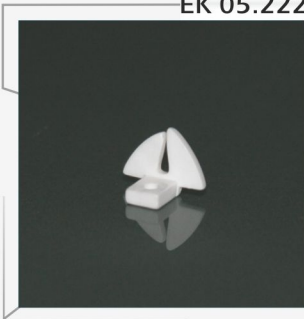

EK 05.237

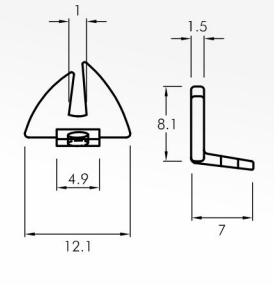

EK 05.300

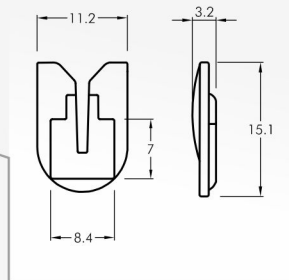
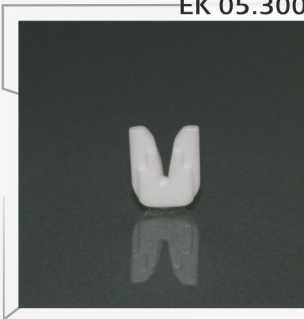

EK 05.301

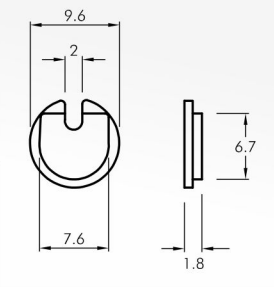

EK 05.302

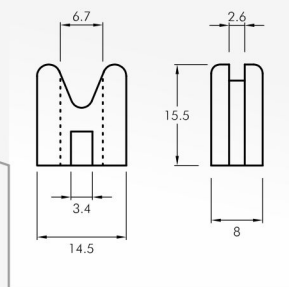
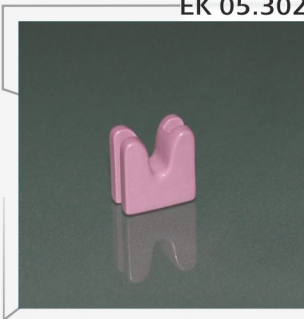

EK 05.303

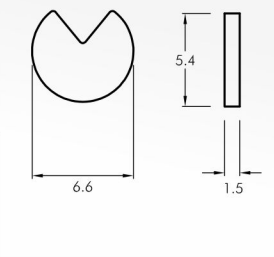
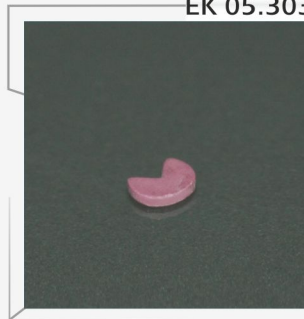

EK 05.304

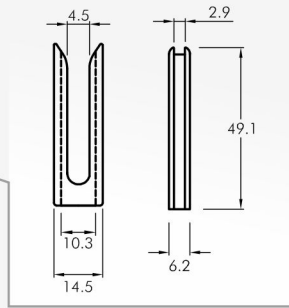
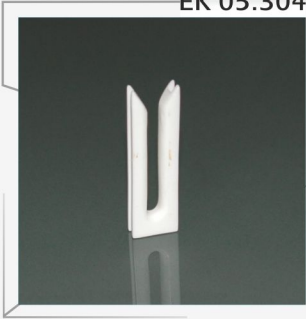

EK 05.305

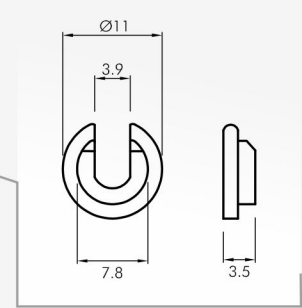
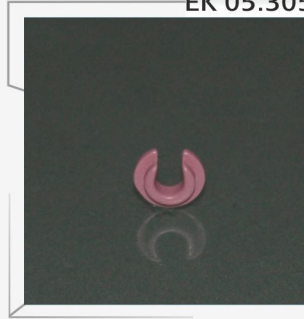

EK 05.306

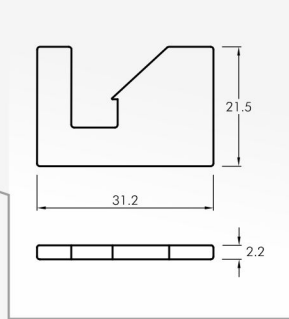
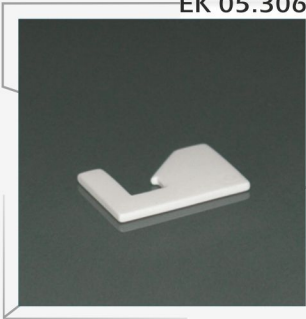

EK 05.307

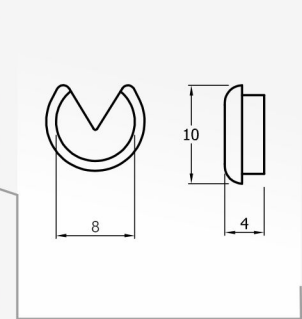

EK 05.308

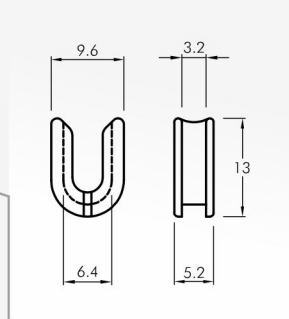
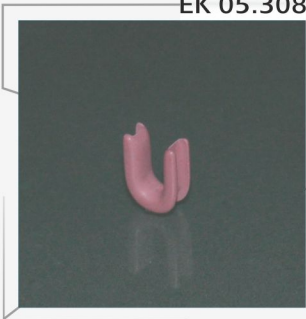

EK 05.309

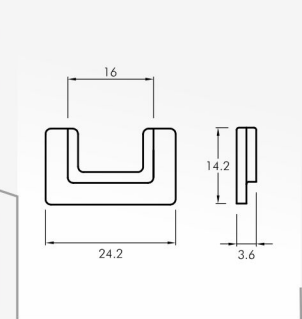

EK 05.310

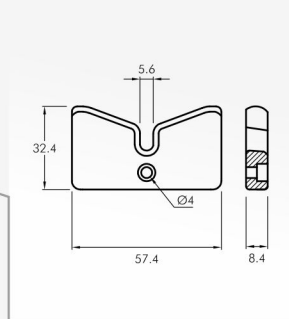
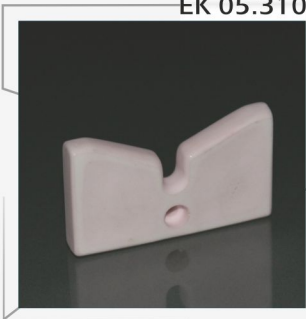

EK 05.311

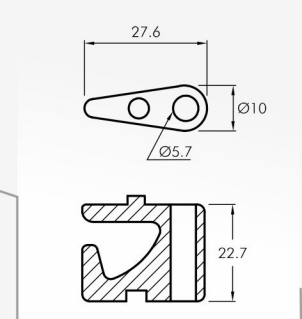

EK 05.312

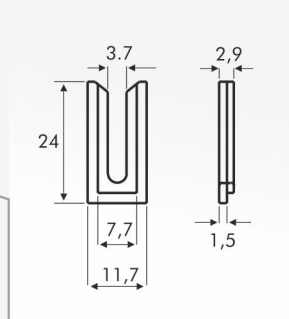
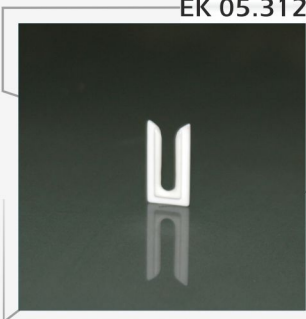

EK 05.313

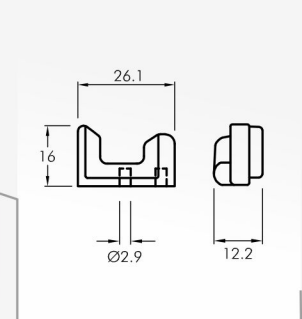
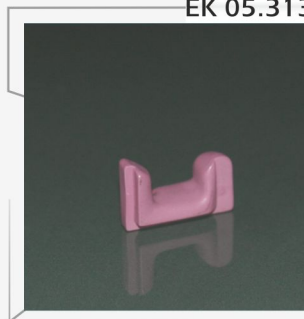

EK 05.314

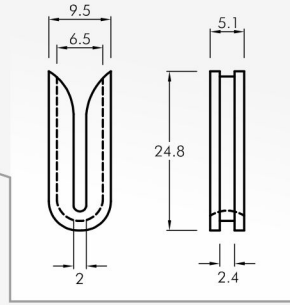
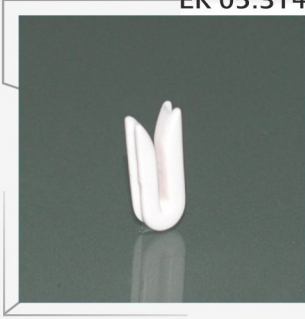

EK 05.315

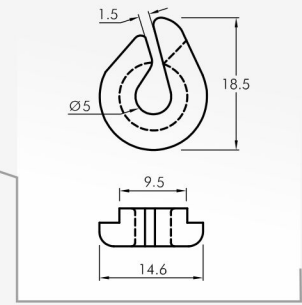
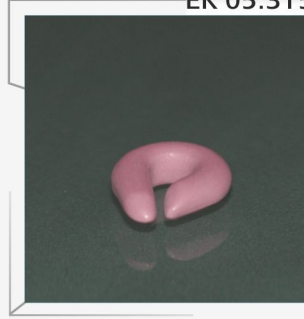

EK 05.316

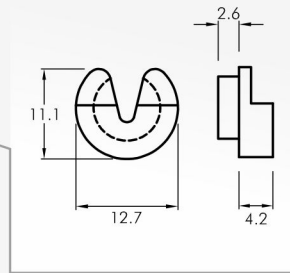
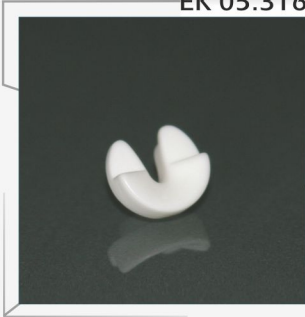

EK 05.317

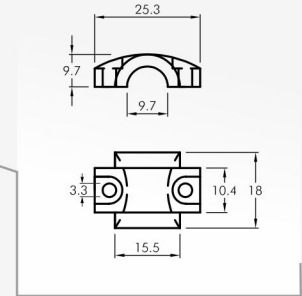

EK 05.318

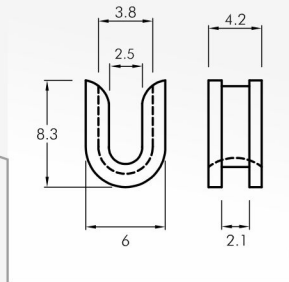
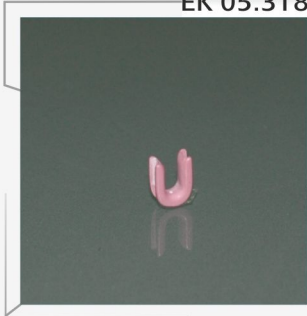

EK 05.319

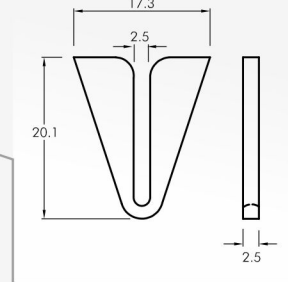
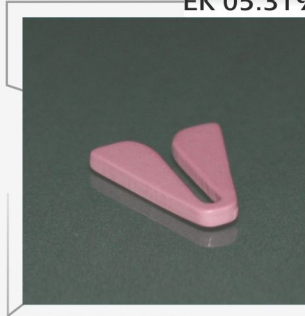

EK 05.320

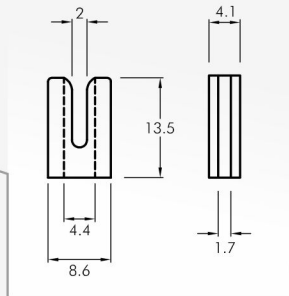
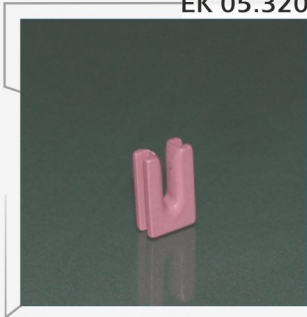

EK 05.323

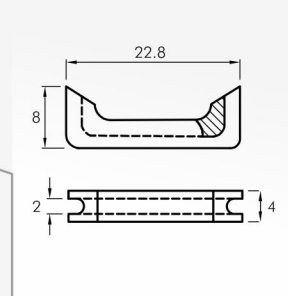

EK 05.324

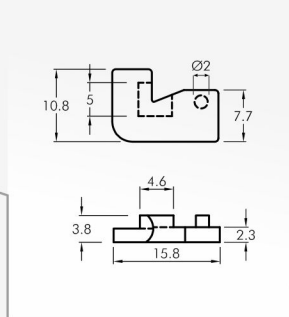
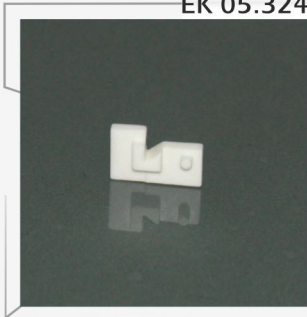

EK 05.325

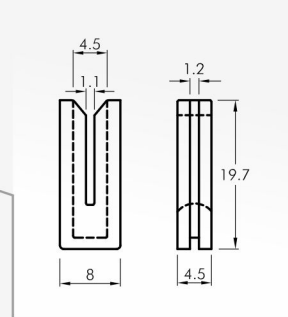
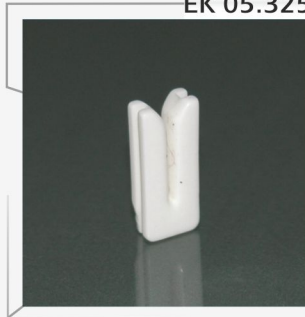

EK 05.326

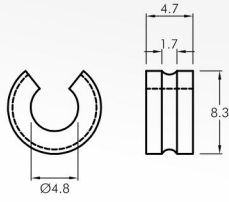
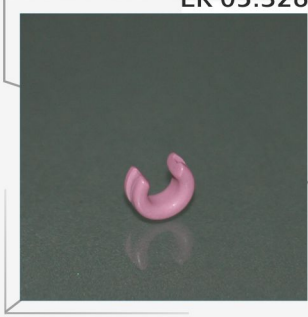

EK 05.327

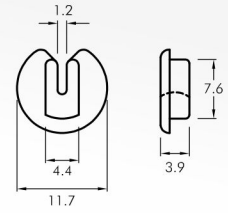
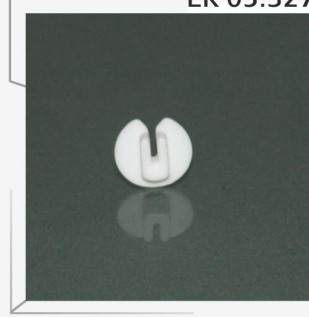

EK 05.328

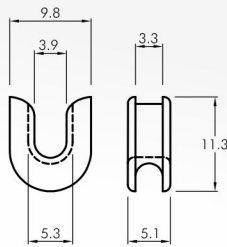
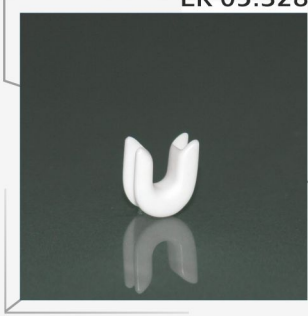

EK 05.329

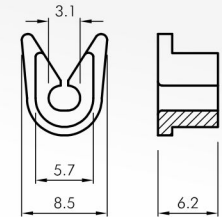
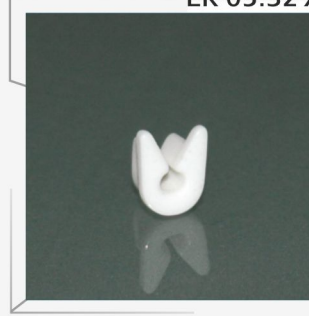

EK 05.330

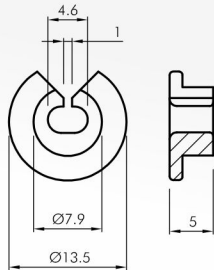
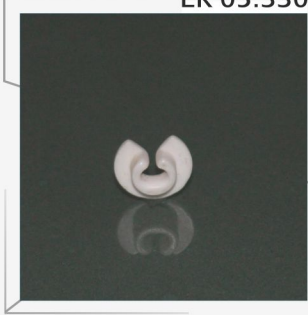

EK 05.331

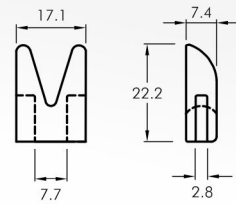
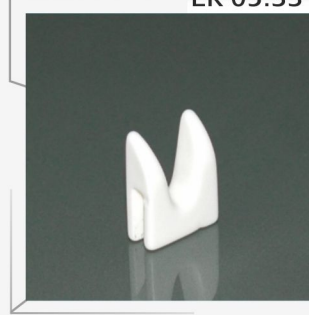

EK 05.332

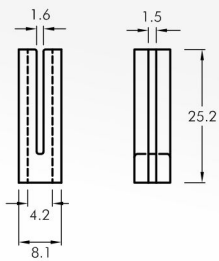
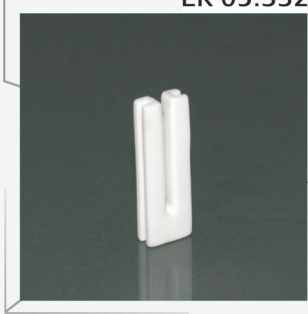

EK 05.333

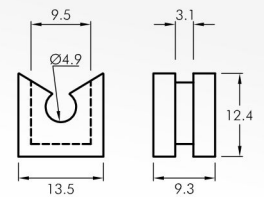
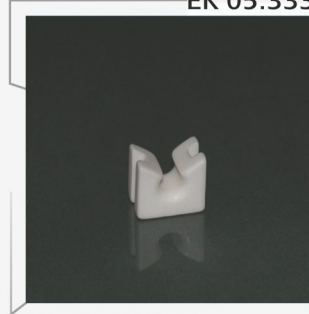

EK 05.334

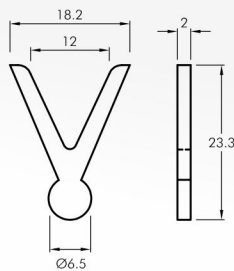

EK 05.335

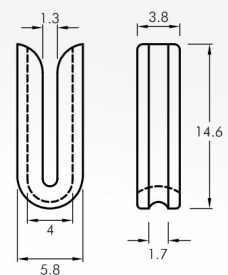
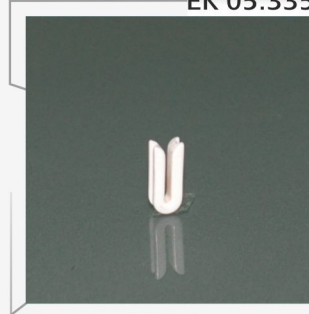

EK 05.336

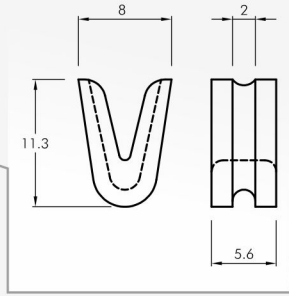
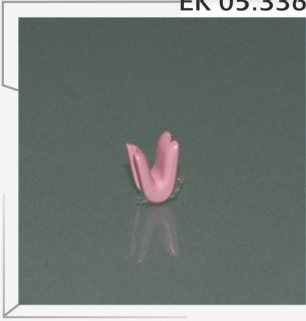

EK 05.337

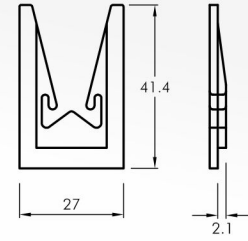
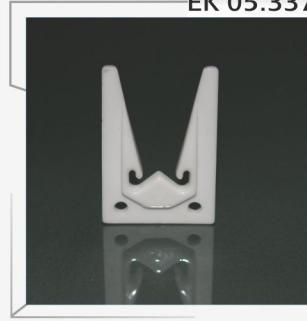

EK 05.338

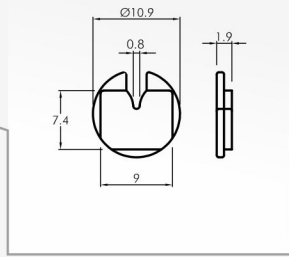
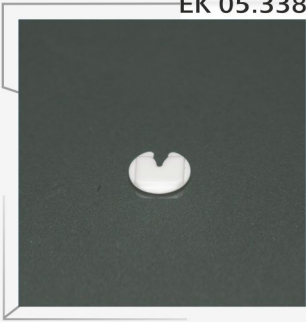

EK 05.339

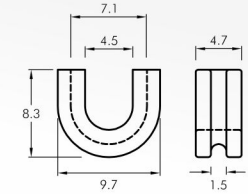
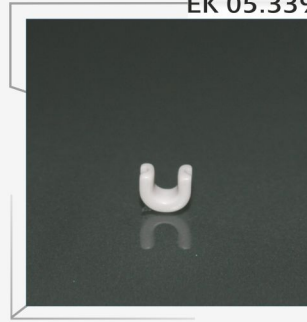

EK 05.340

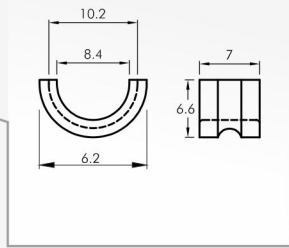
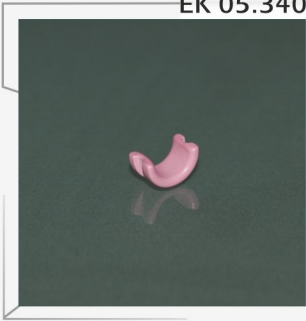

EK 05.341

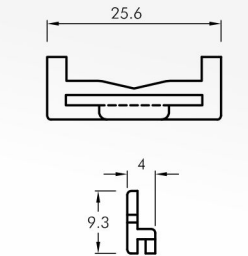

EK 05.342

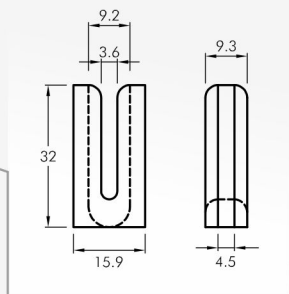

EK 05.343

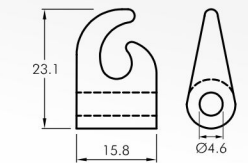

EK 05.344

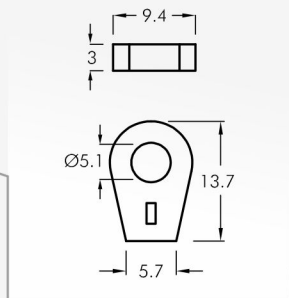
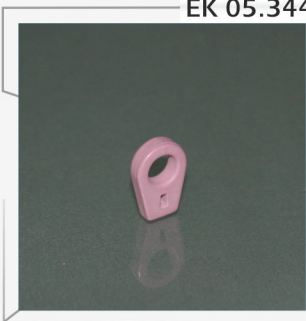

EK 05.345

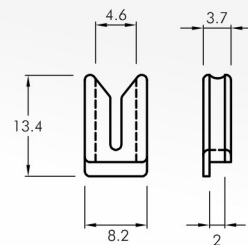

EK 05.346

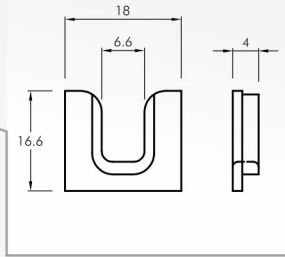
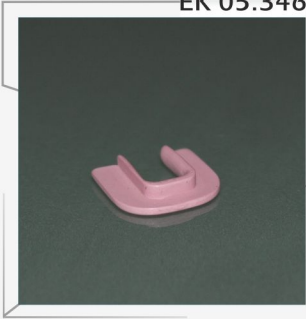

EK 05.347

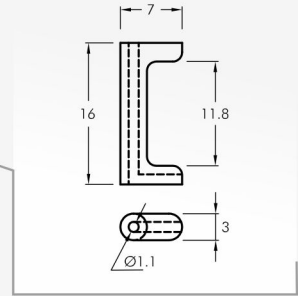
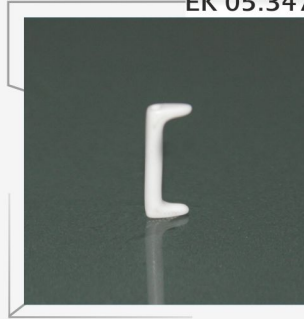

EK 05.348

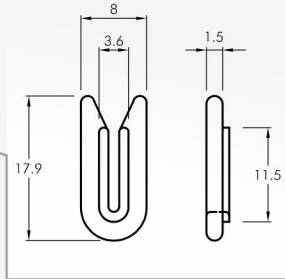

EK 05.349

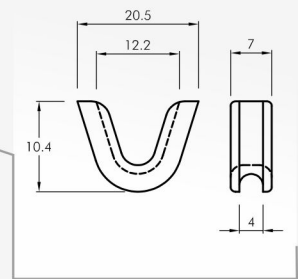
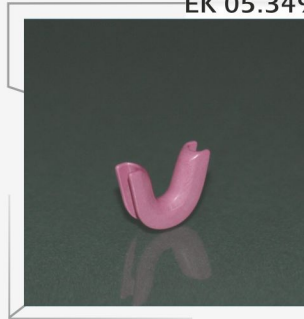

EK 05.350

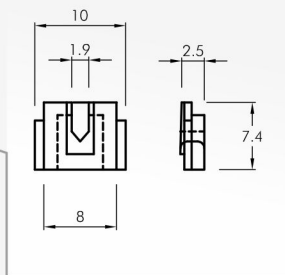
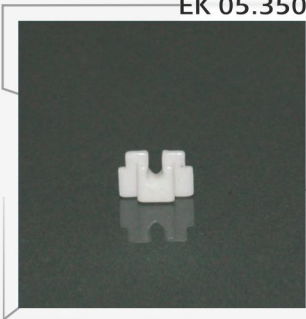

EK 05.351

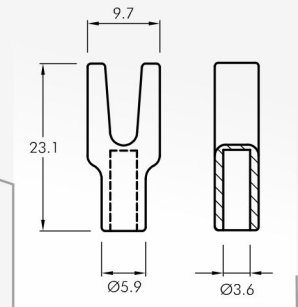
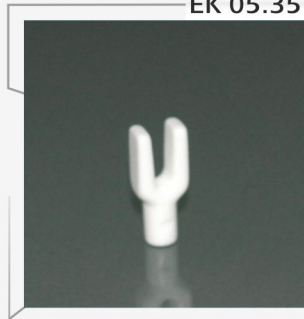

EK 05.352

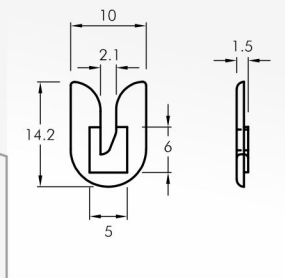

EK 05.353

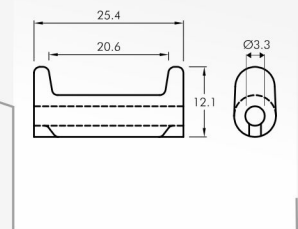

EK 05.354

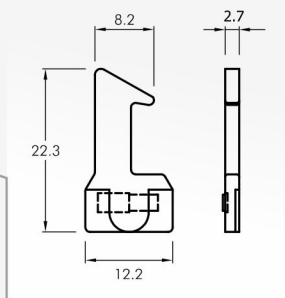

EK 05.355

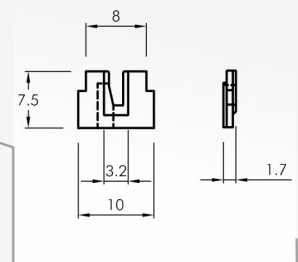
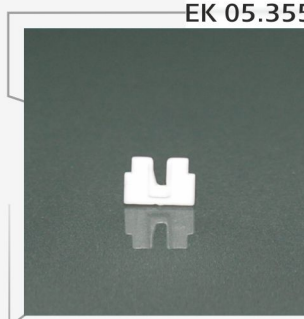

EK 05.356

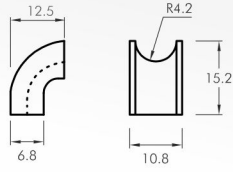
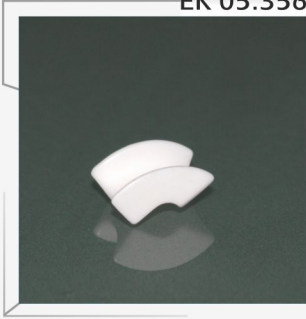

EK 05.357

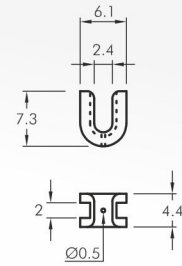
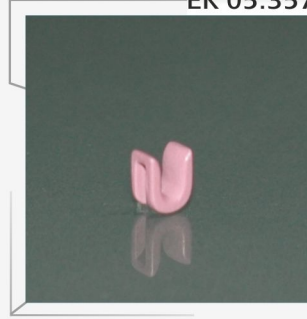

EK 05.358

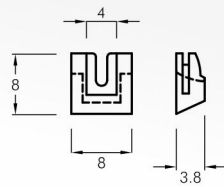

EK 05.359

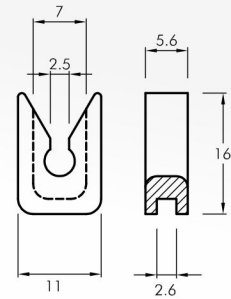
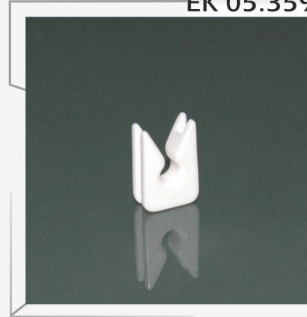

EK 05.360

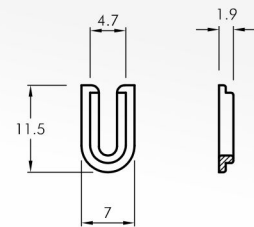
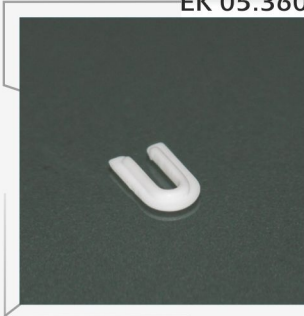

EK 05.361

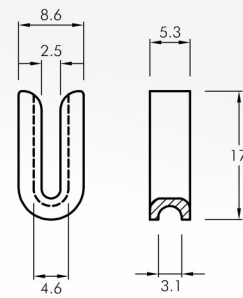
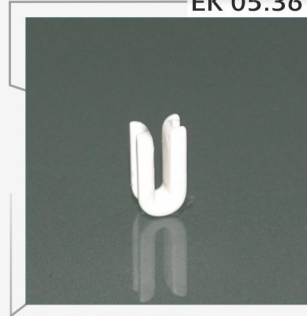

EK 05.362

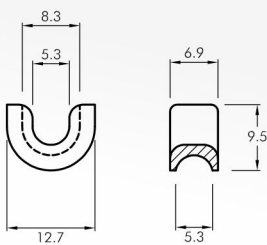
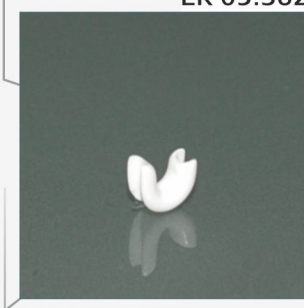

EK 05.363

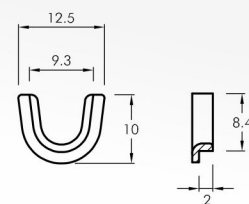
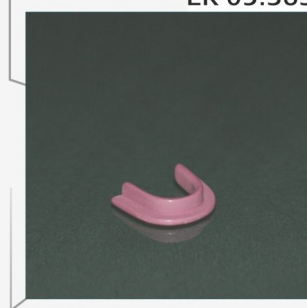

EK 05.364

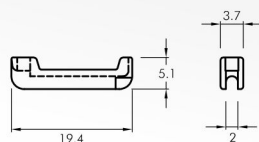
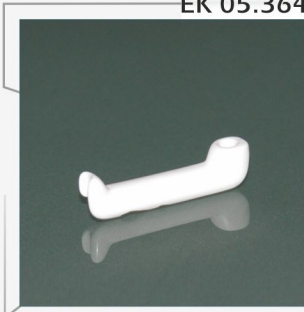

EK 05.365

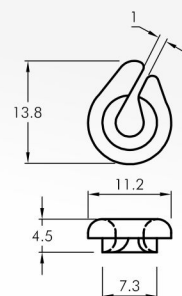

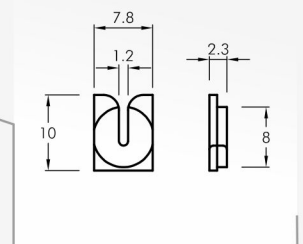
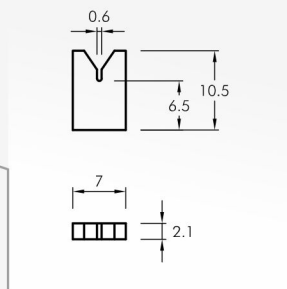
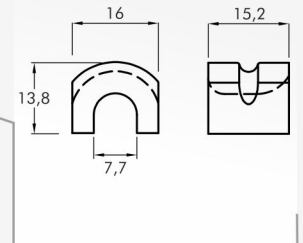
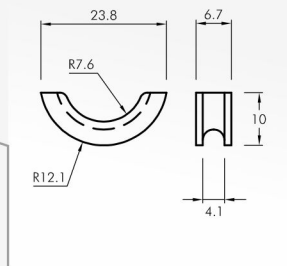
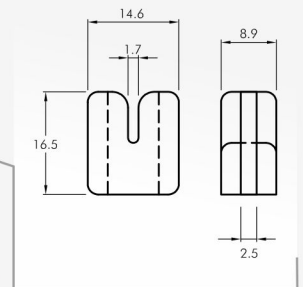
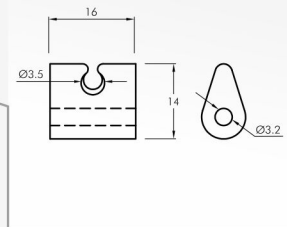
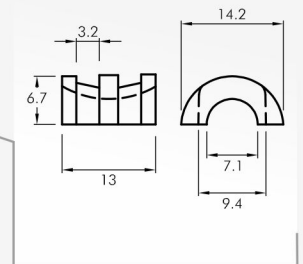
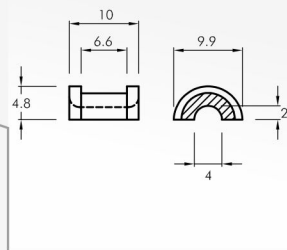
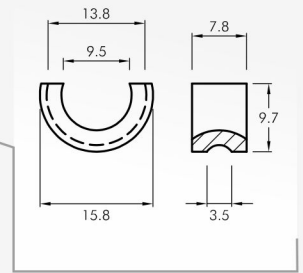
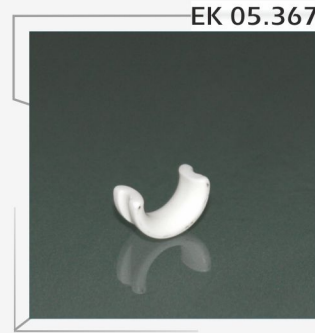
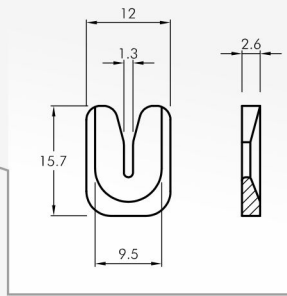

EK 05.376

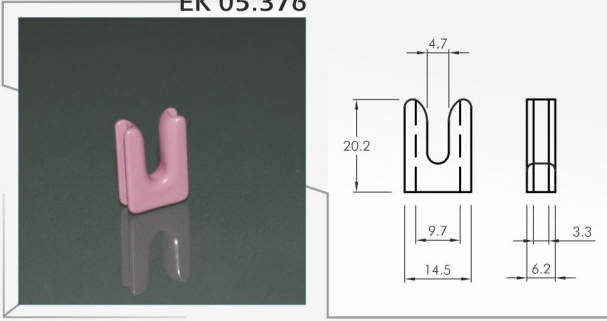

EK 05.377

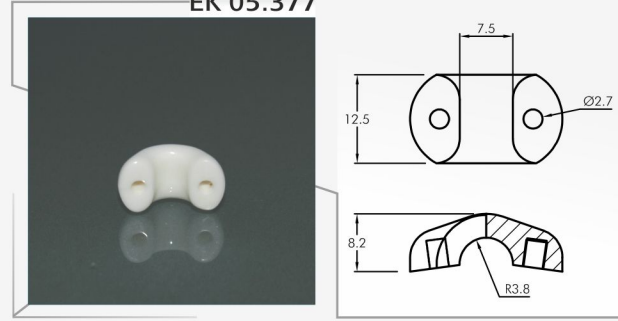

EK 05.378

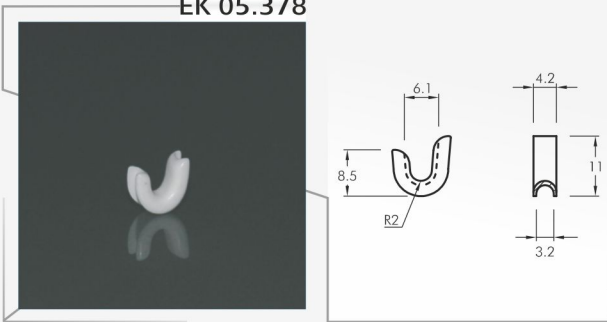

EK 05.379

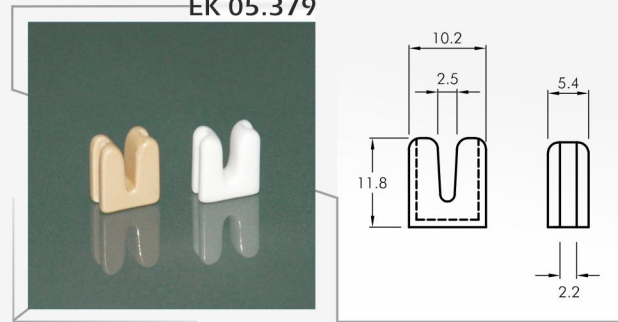

EK 05.380

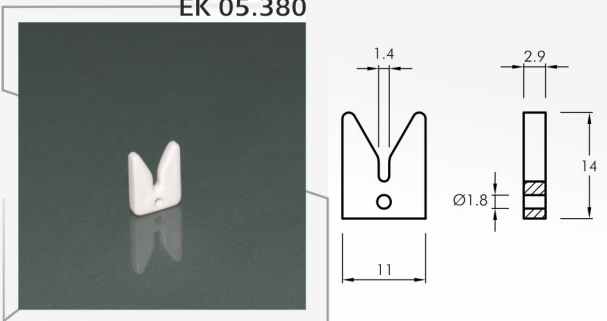

EK 05.381

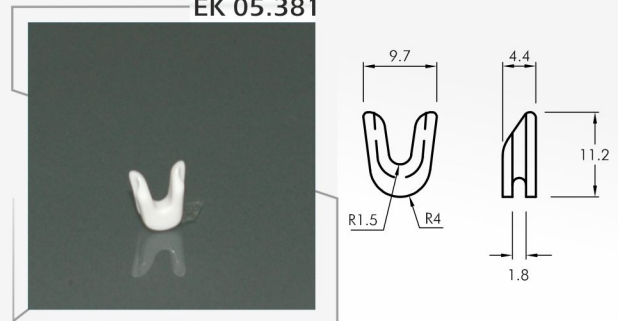

EK 05.382

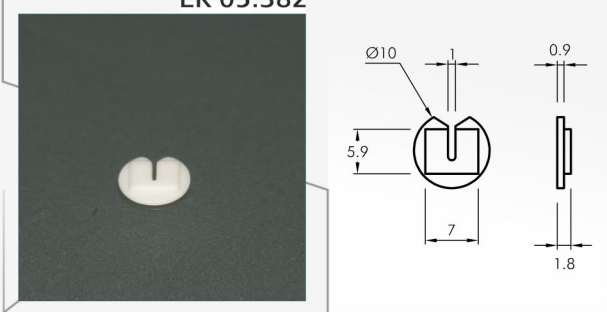

EK 05.383

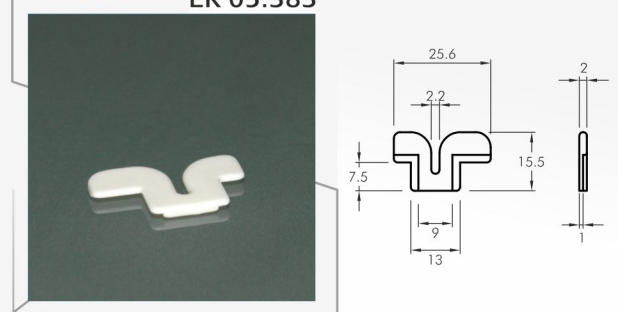

EK 05.384

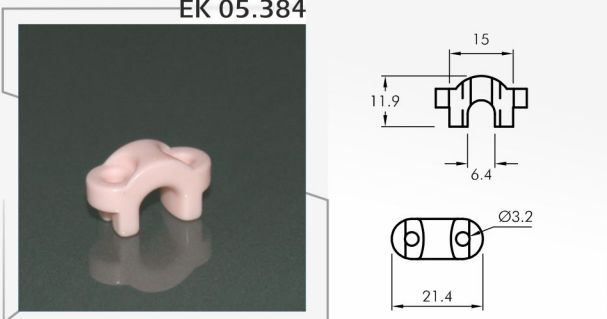

EK 05.385

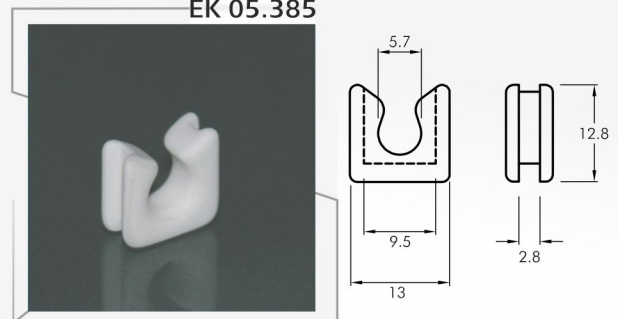

EK 05.386

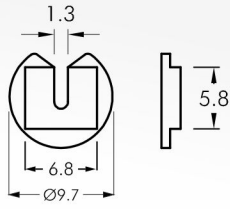
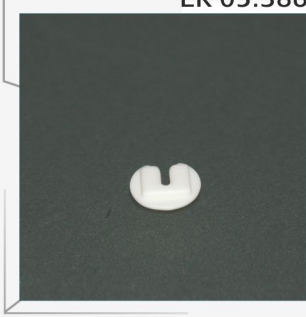

EK 05.387

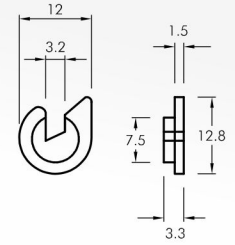
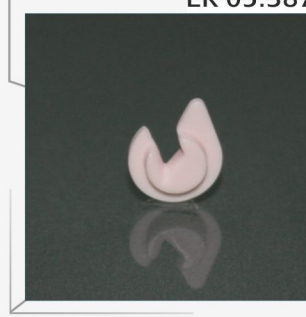

EK 05.388

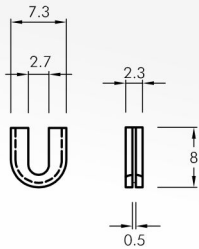
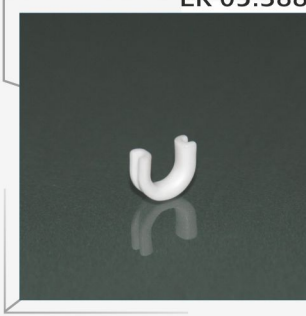

EK 05.389

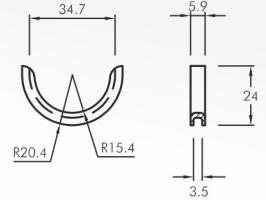

EK 05.390

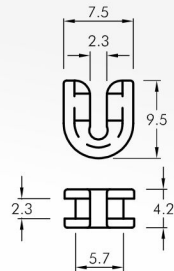
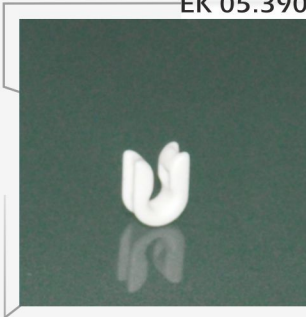

EK 05.391

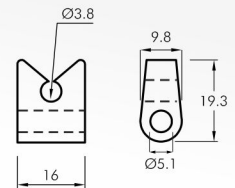
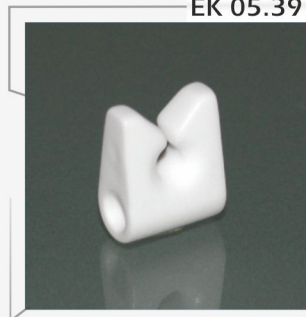

EK 05.392

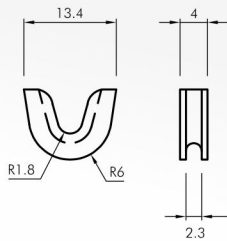
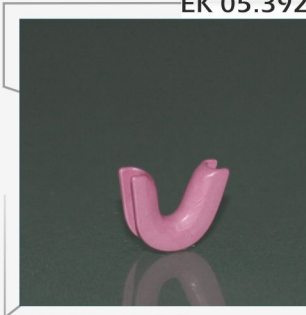

EK 05.393

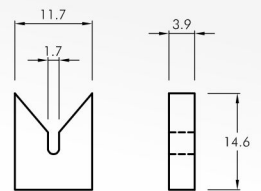

EK 05.394

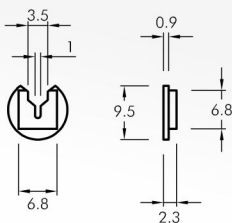

EK 05.395

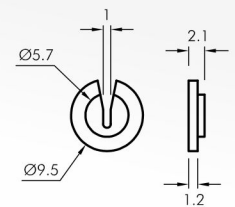

EK 05.396

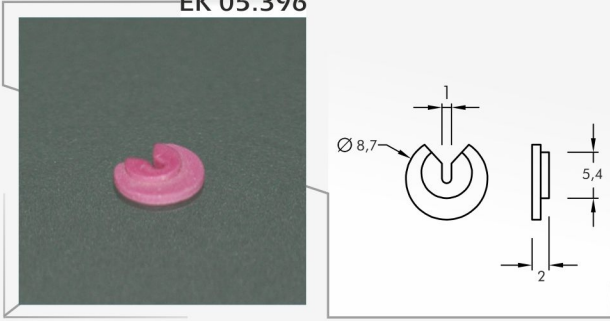

EK 05.397

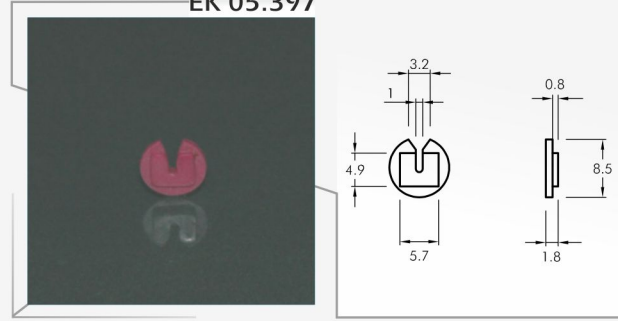

EK 05.398

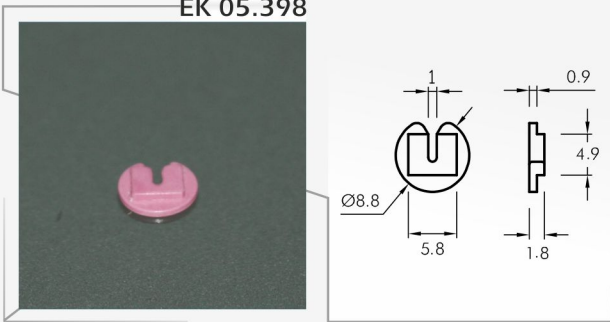

EK 05.399

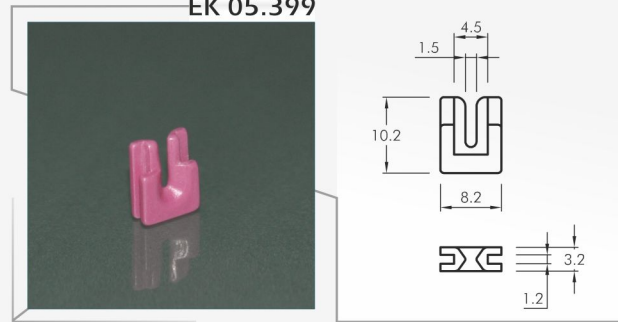

EK 05.400

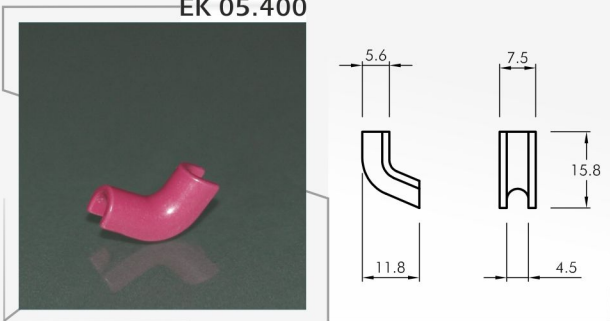

EK 05.401

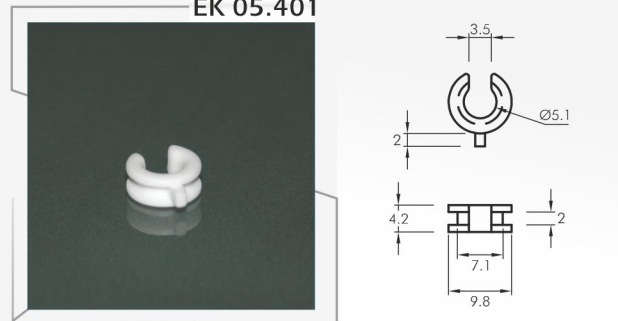

EK 05.402

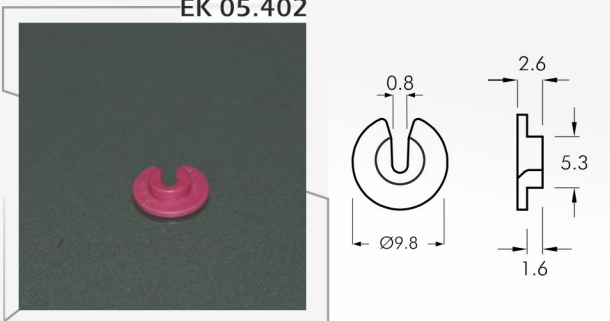

EK 05.403

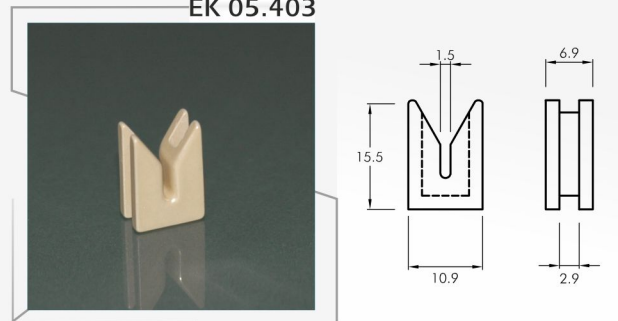

EK 05.404

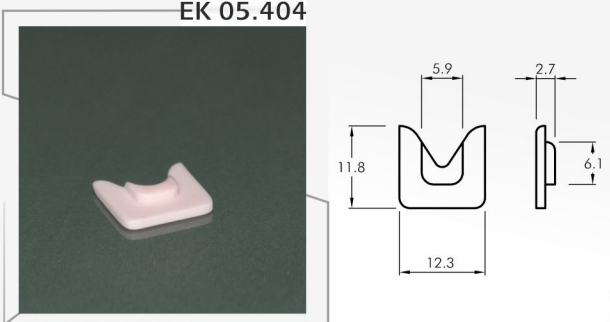

EK 05.405

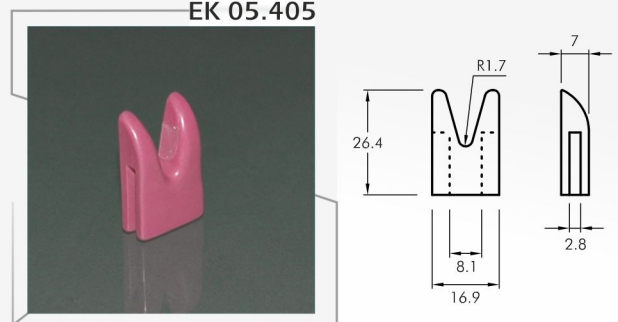

EK 05.407

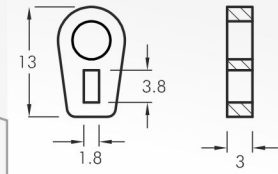
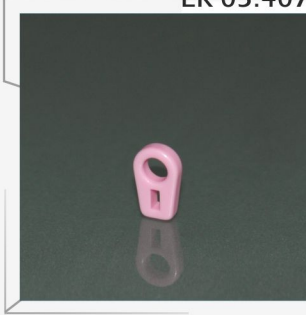

EK 05.408

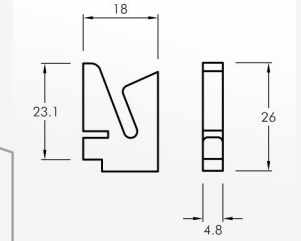
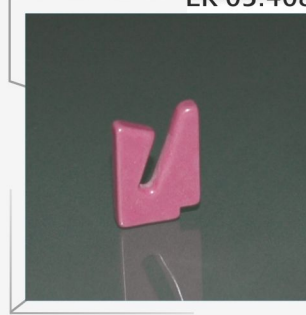

EK 05.409

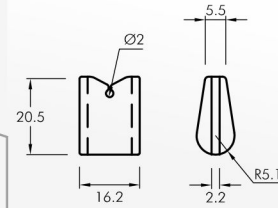
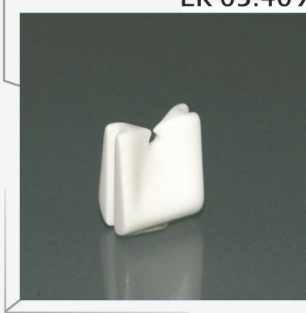

EK 05.410

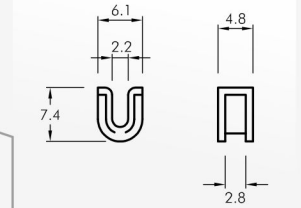
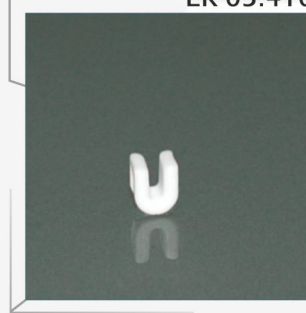

EK 05.411

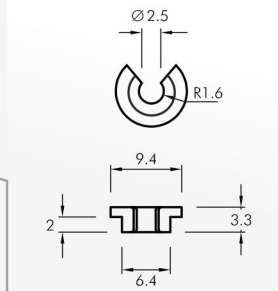
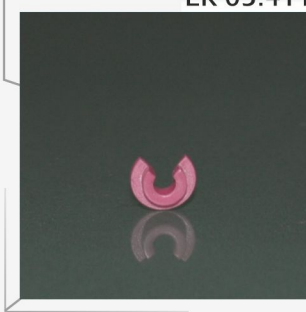

EK 05.412

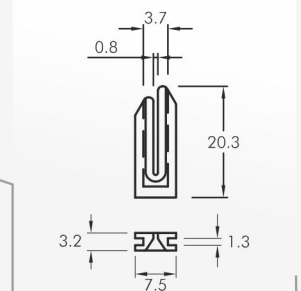
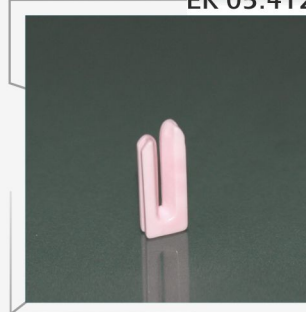

EK 05.413

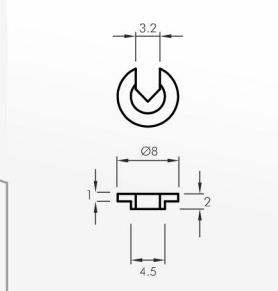
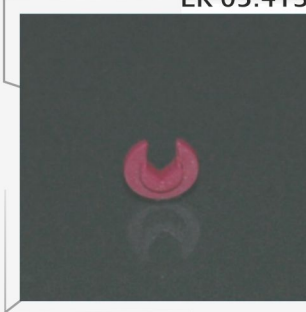

EK 05.414

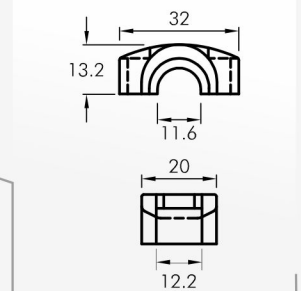

EK 05.415

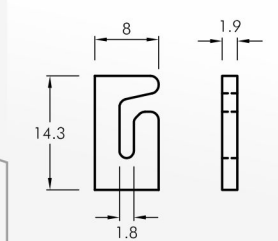
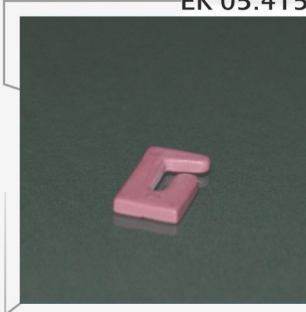

EK 05.416

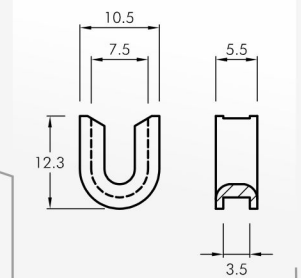
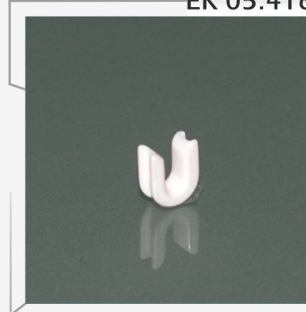

EK 05.417

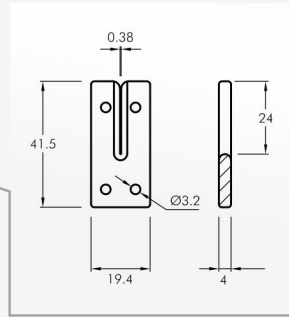
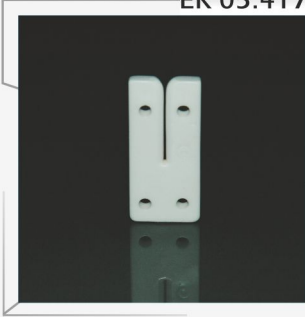

EK 05.419

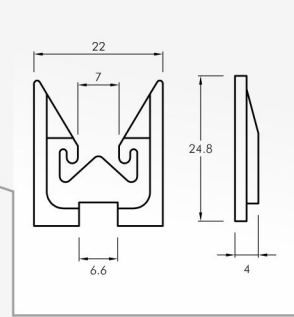
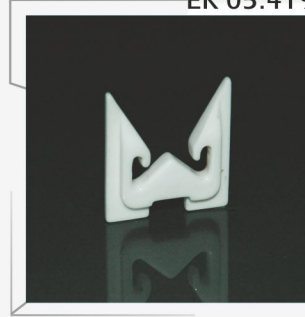

EK 05.420

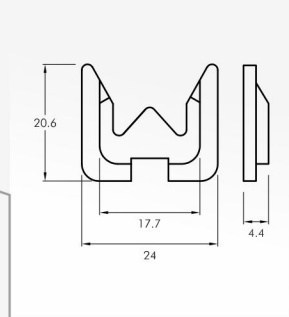
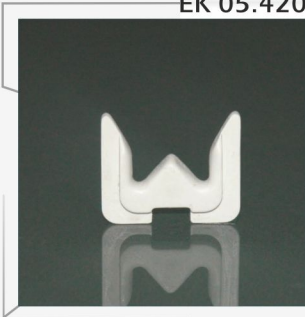

EK 05.421

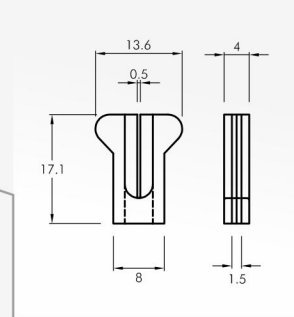
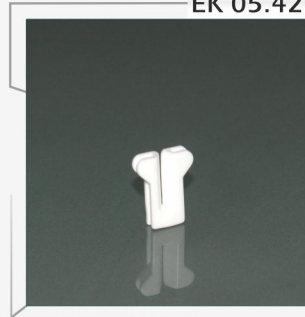

EK 05.423

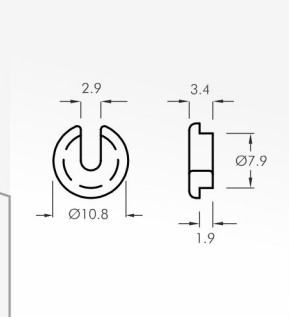
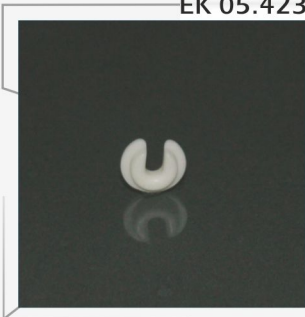

EK 05.422

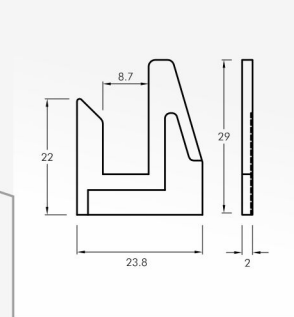

EK 05.424

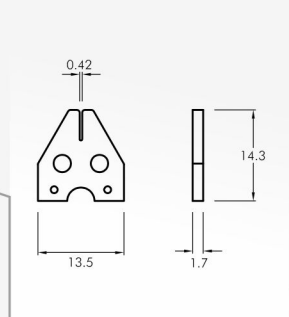

EK 05.425

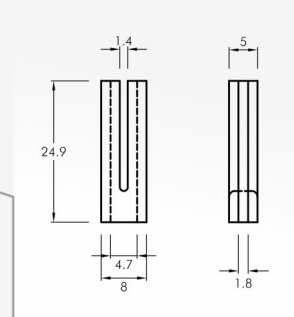
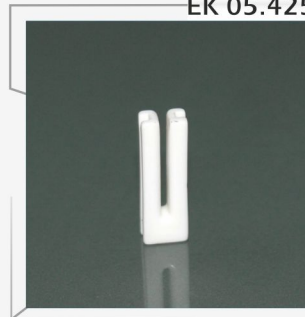

EK 05.426

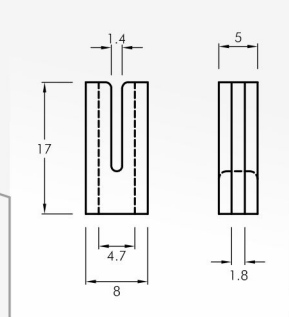
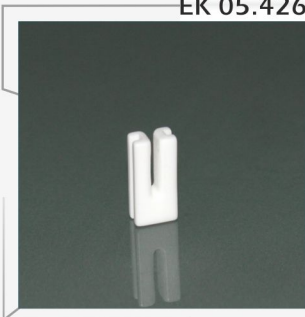

EK 05.427

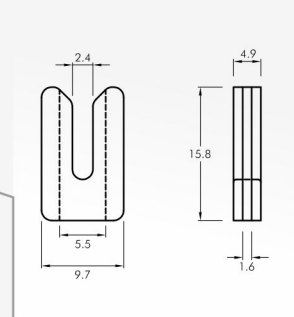
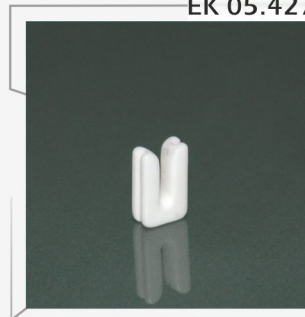

EK 05.428

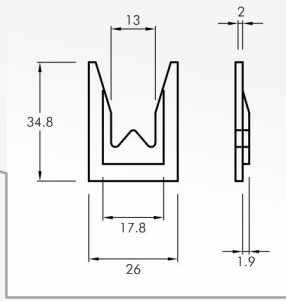
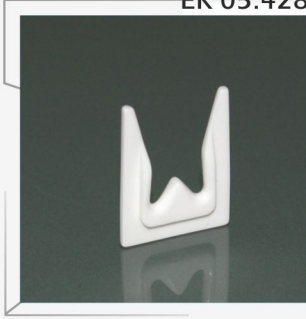

EK 05.429

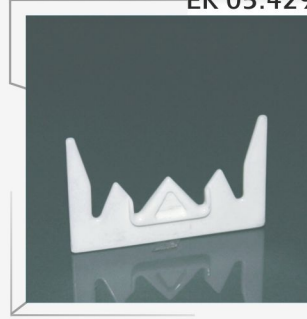

EK 05.430

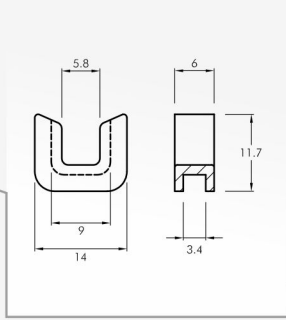
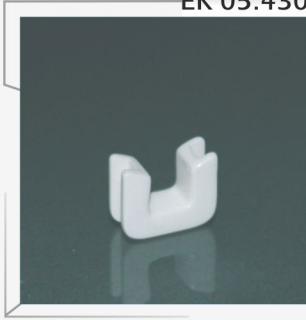

EK 05.431

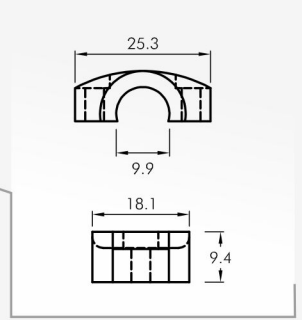

EK 05.432

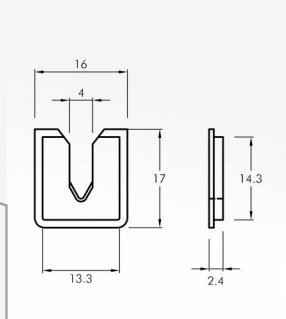

EK 05.433

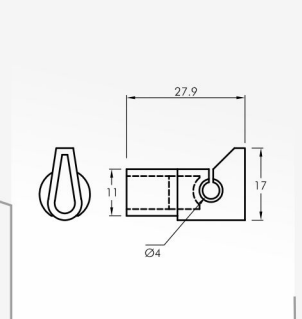

EK 05.434

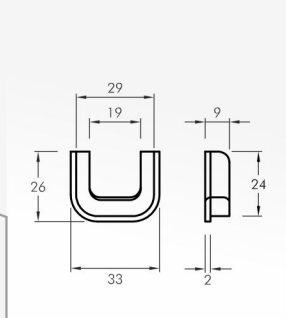

EK 05.435

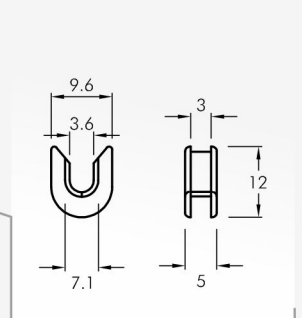
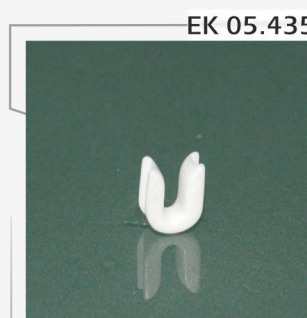

EK 05.436

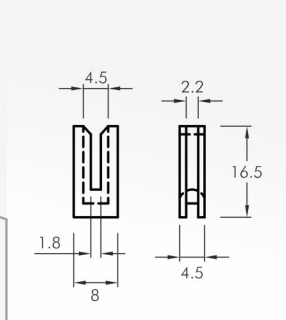
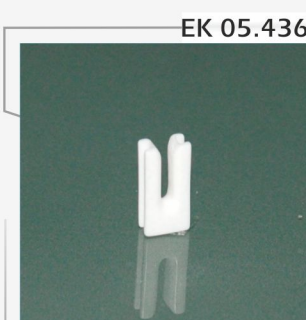

EK 05.437

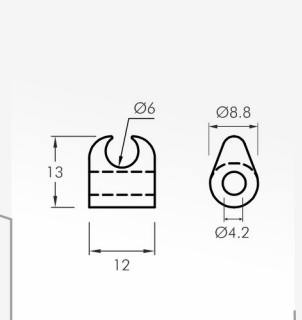

EK 05.438

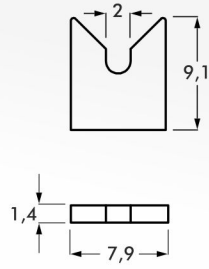
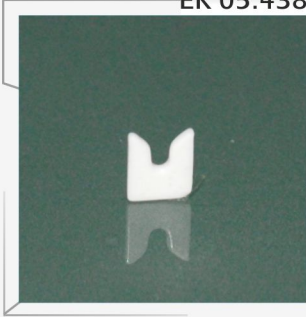

EK 05.439

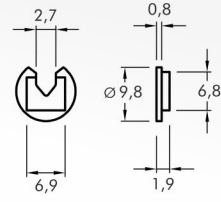
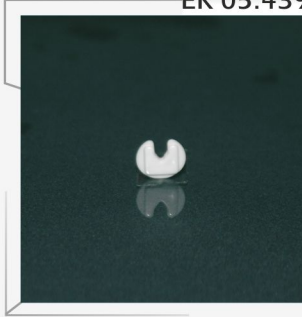

EK 05.440

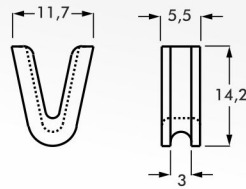
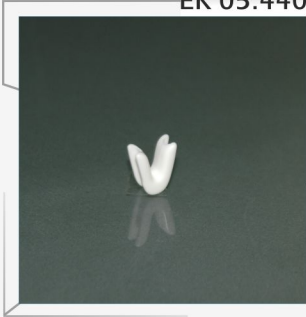

EK 05.441

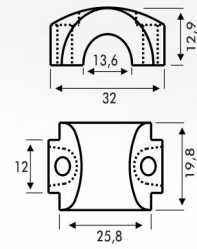

EK 05.442

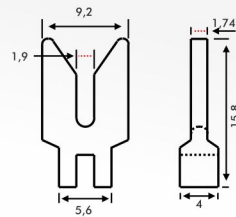
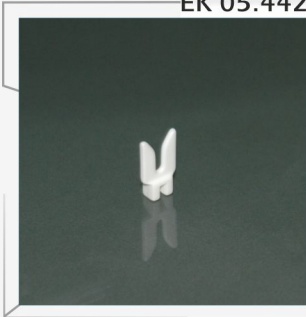

EK 05.443

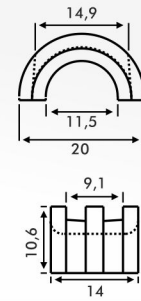
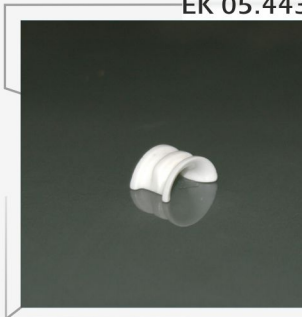

EK 05.444

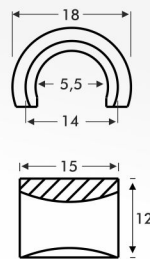
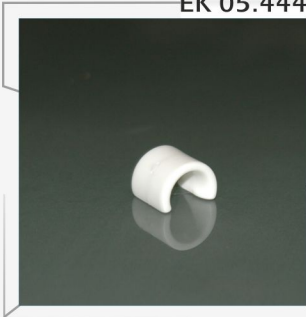

EK 05.445

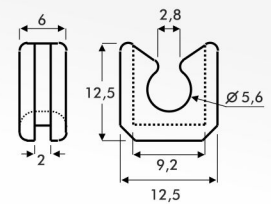
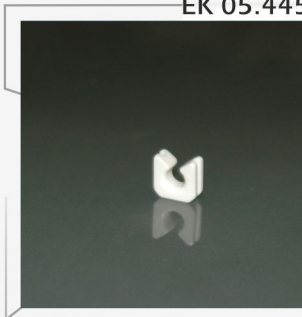

EK 05.446

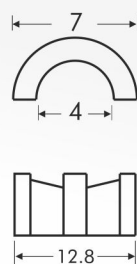
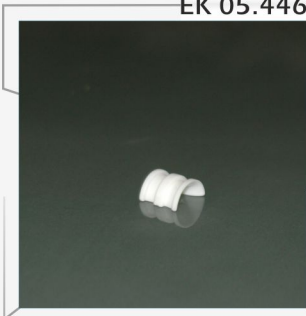

EK 05.447

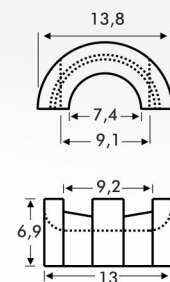
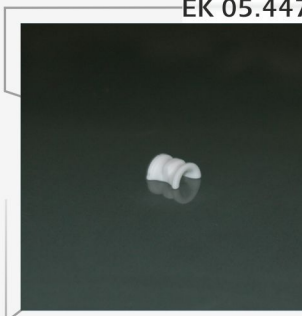

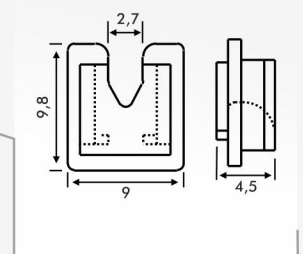
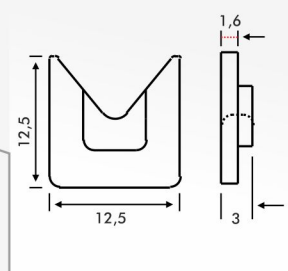
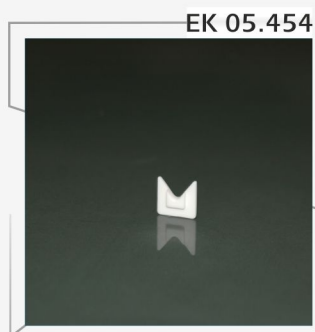
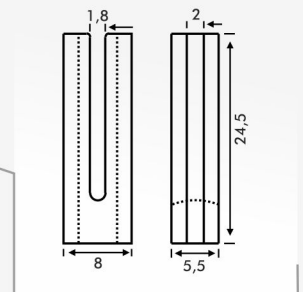
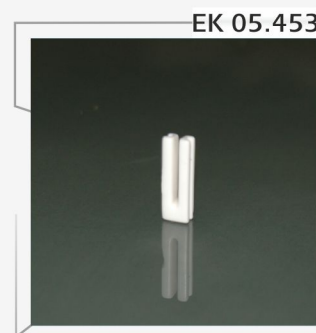
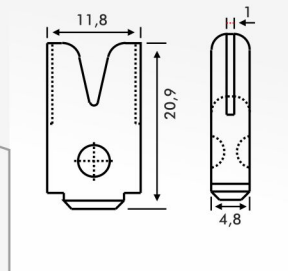
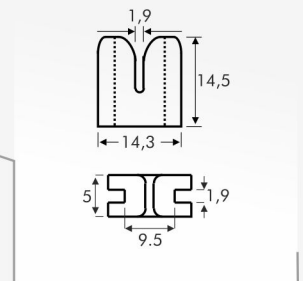
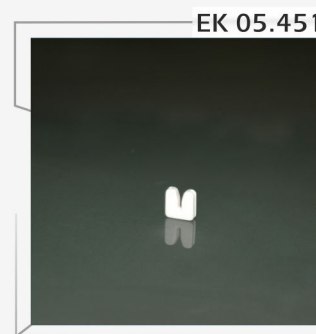
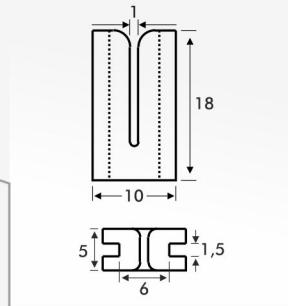
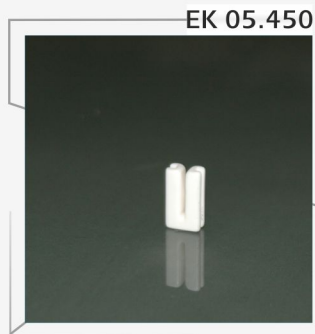
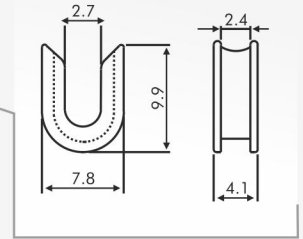
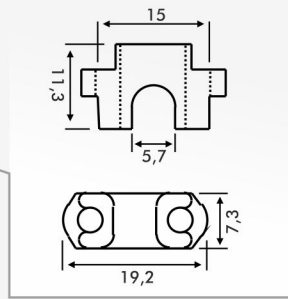

EK 05.201

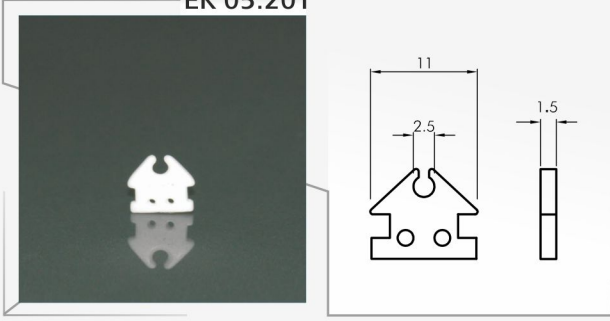

EK 05.202

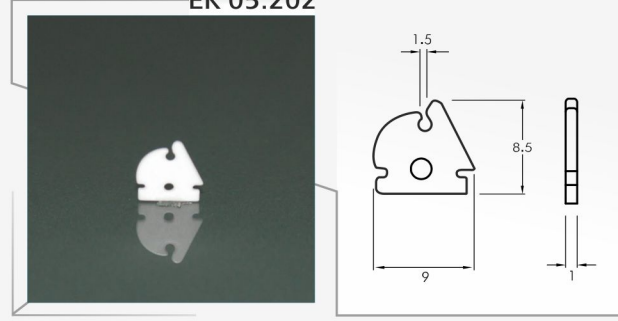

EK 05.203

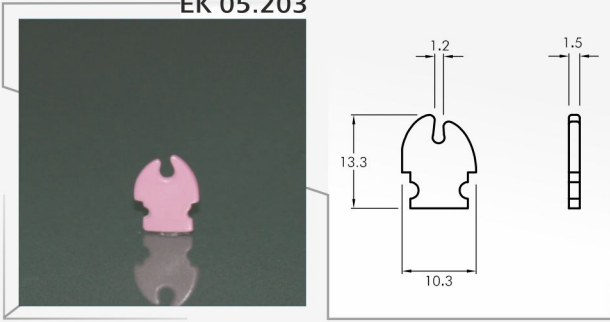

EK 05.204

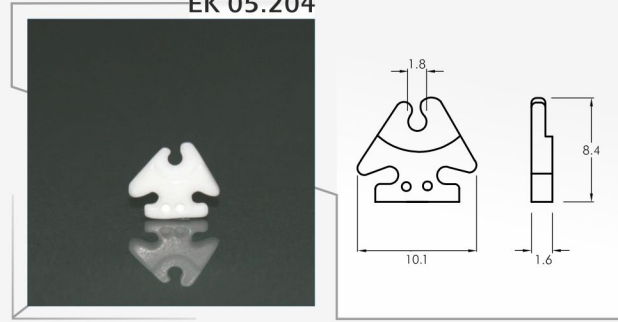

EK 05.205

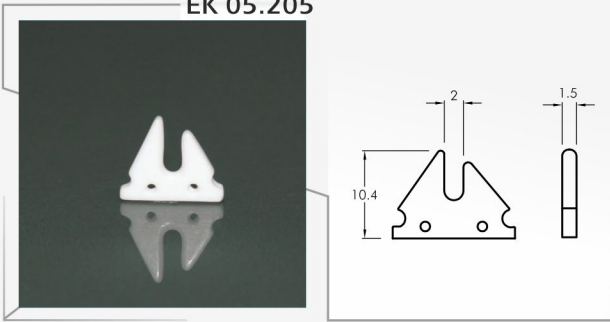

EK 05.207

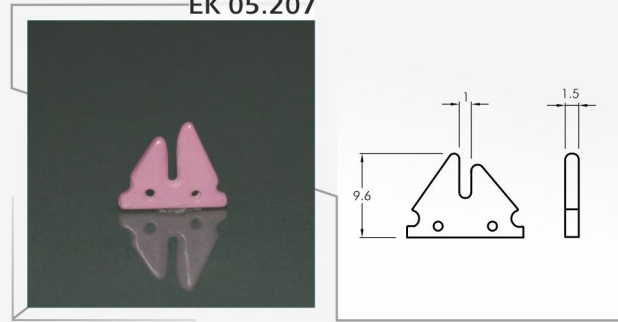

EK 05.208

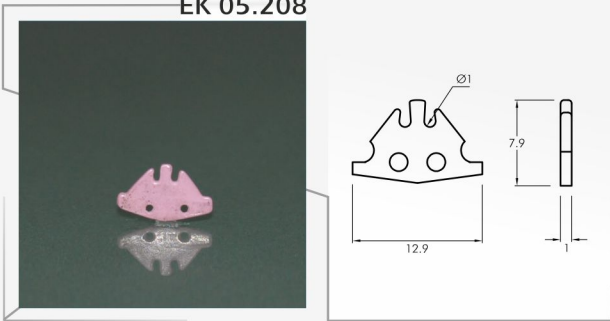

EK 05.209

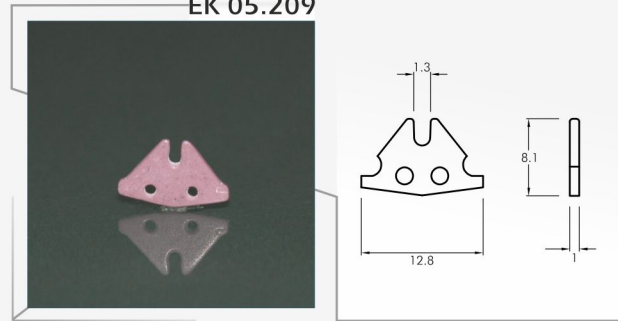

EK 05.210

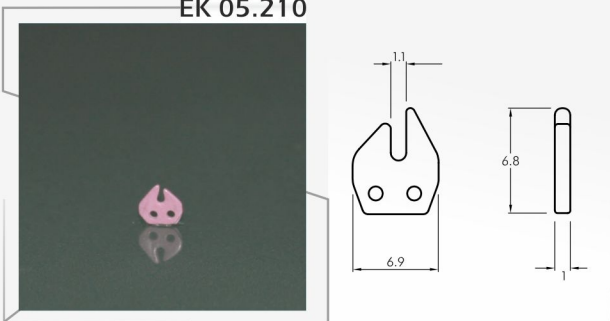

EK 05.211

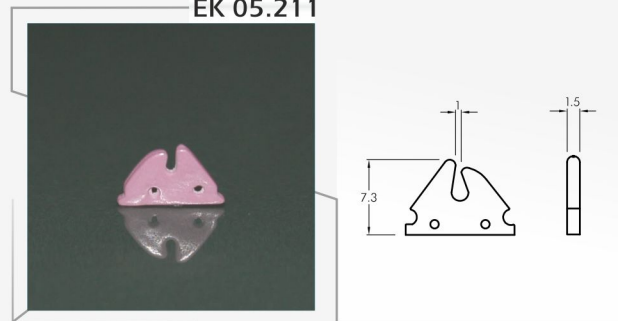

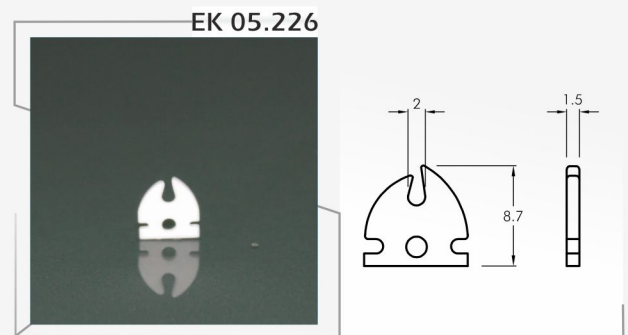
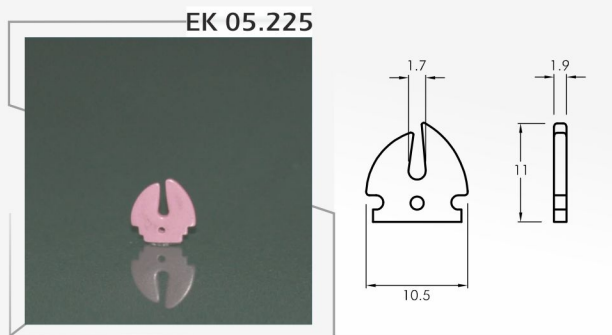
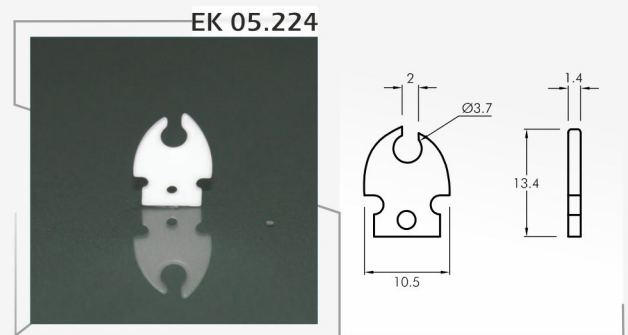
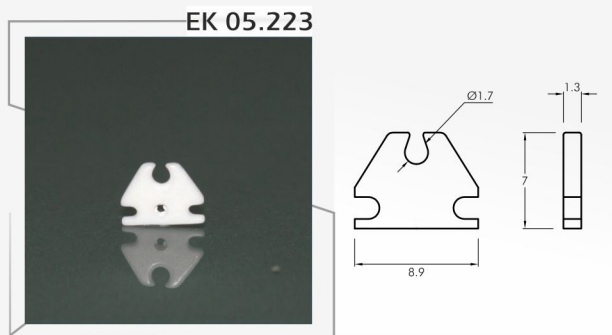
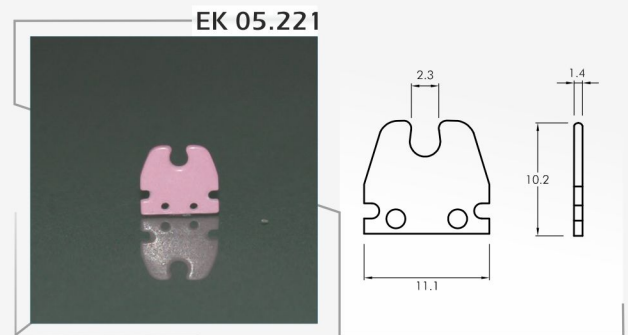
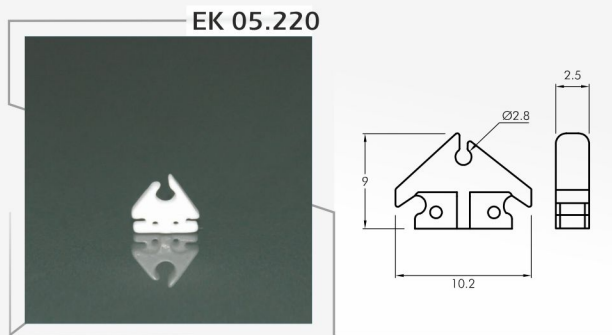
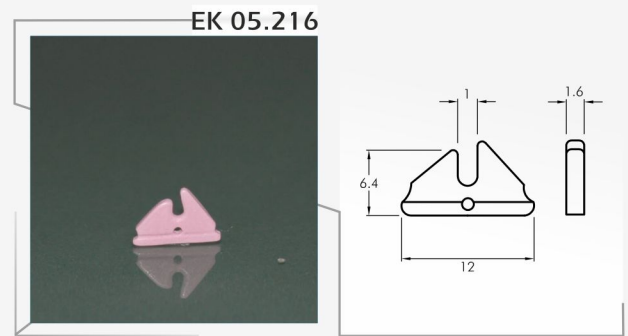
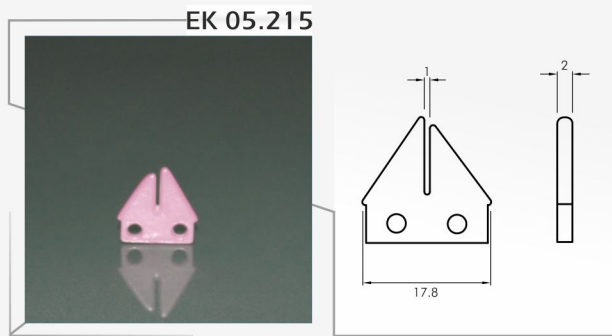
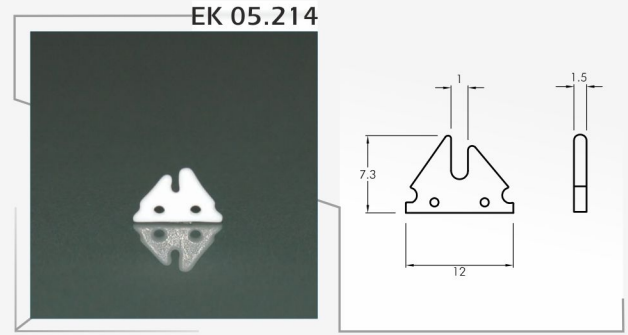
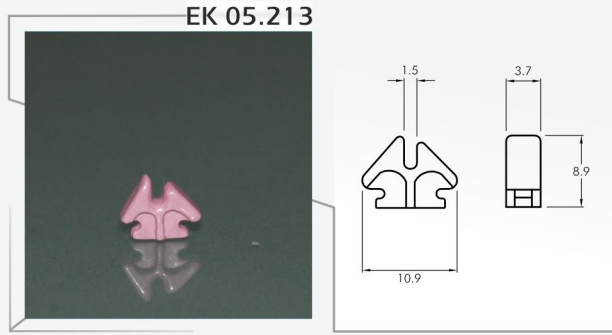

EK 05.227

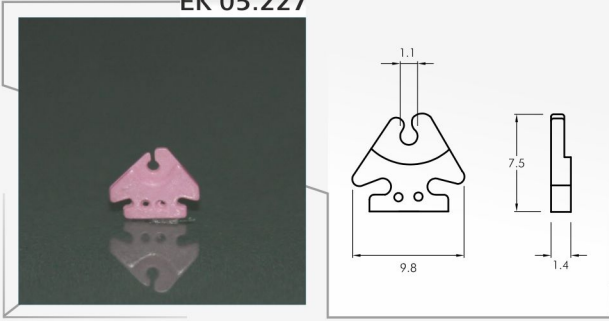

EK 05.228

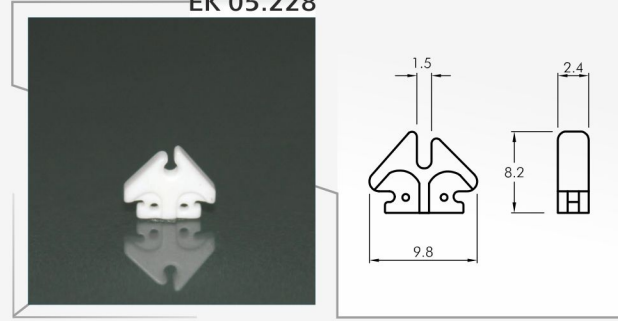

EK 05.229

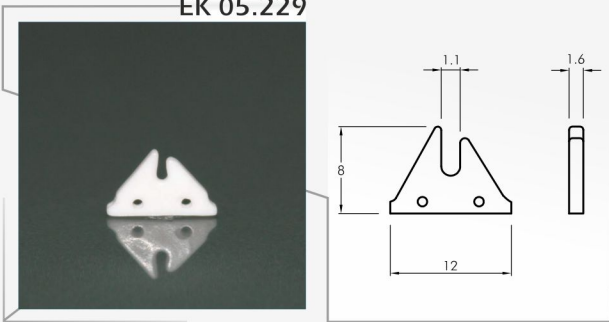

EK 05.230

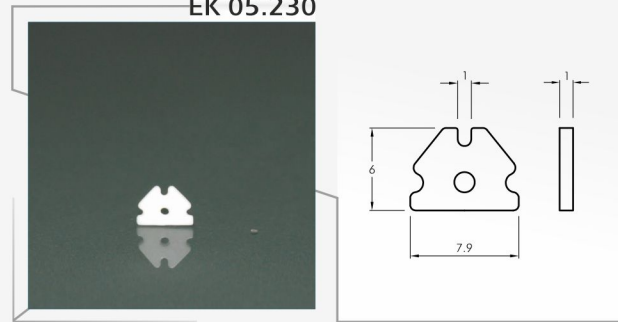

EK 05.231

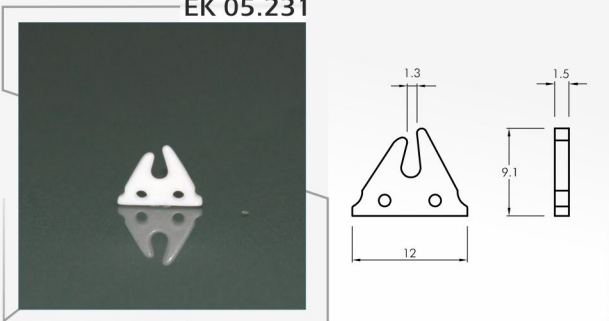

EK 05.233

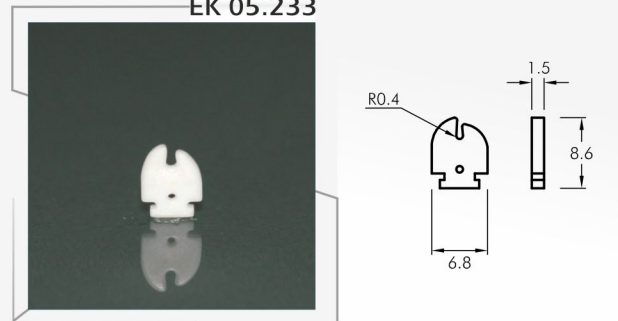

EK 05.234

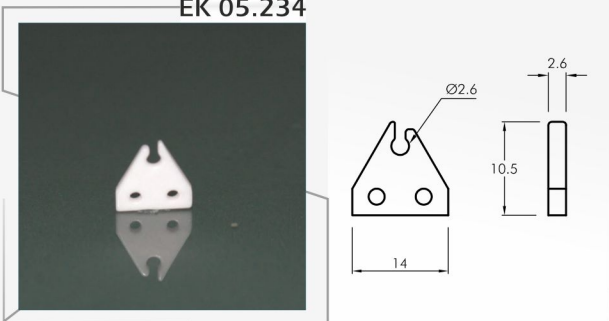

EK 05.235

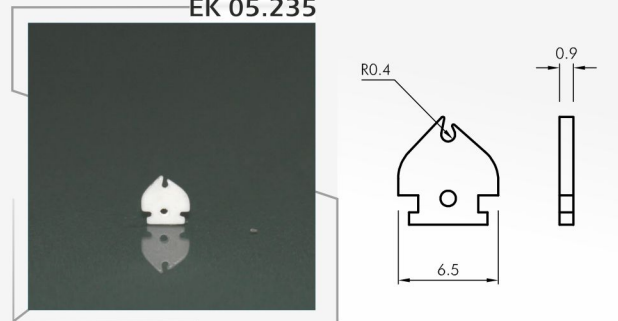

EK 05.236

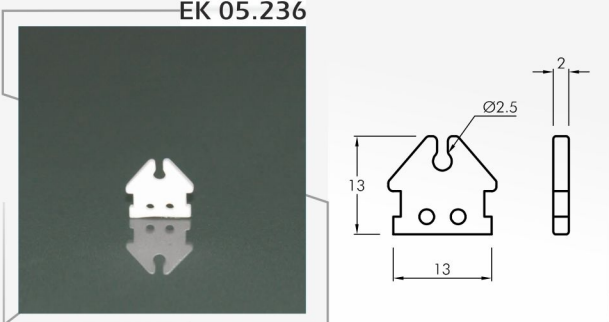

EK 05.238

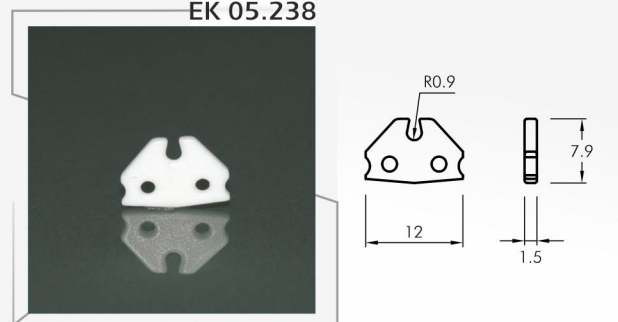

EK 05.239

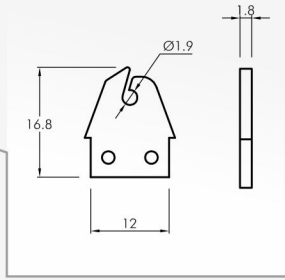
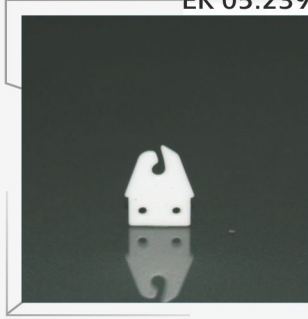

EK 05.241

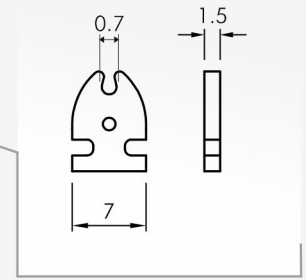
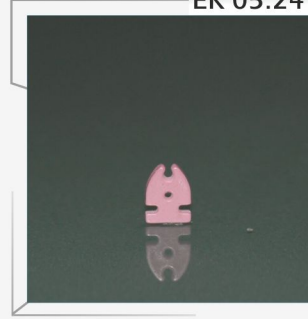

EK 05.242

