

EK.10

ÖZEL KILAVUZLAR SPECIAL GUIDES

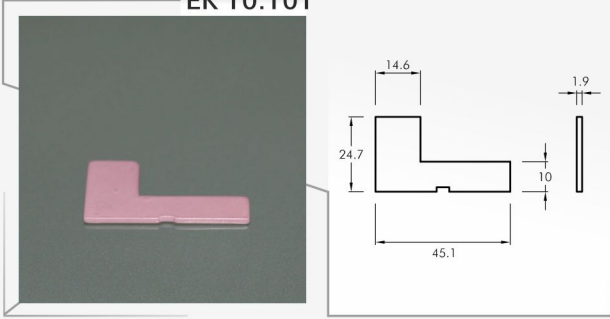

EK 10.101



EK 10.102

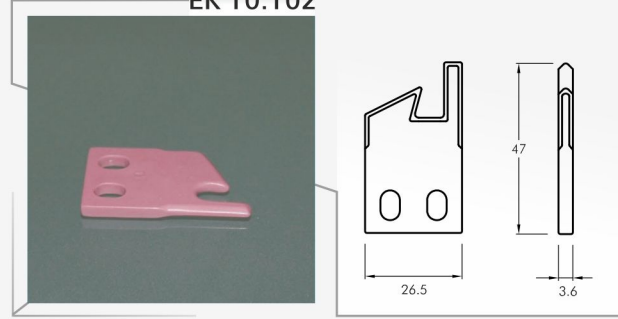

EK 10.103

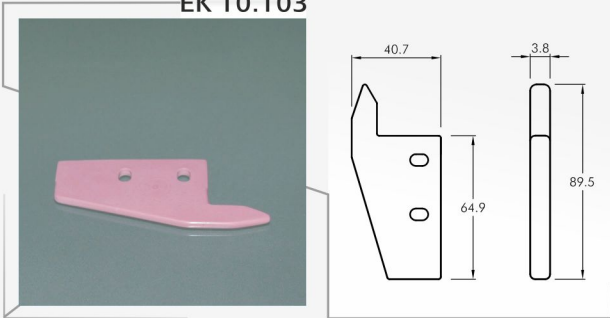

EK 10.104

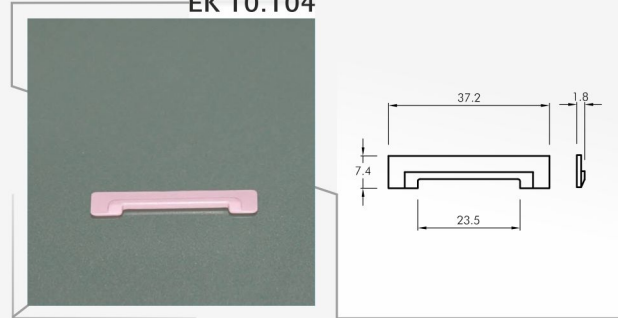

EK 10.105

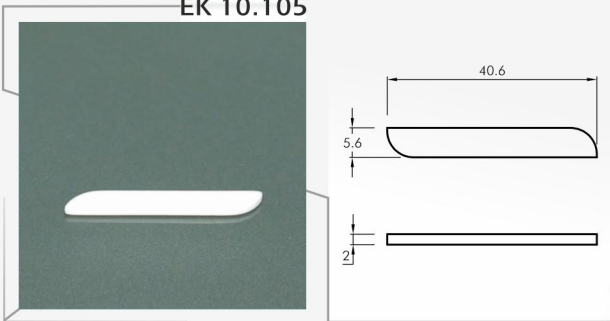

EK 10.106

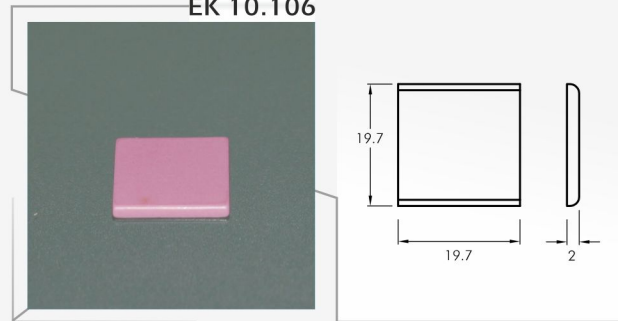

EK 10.107

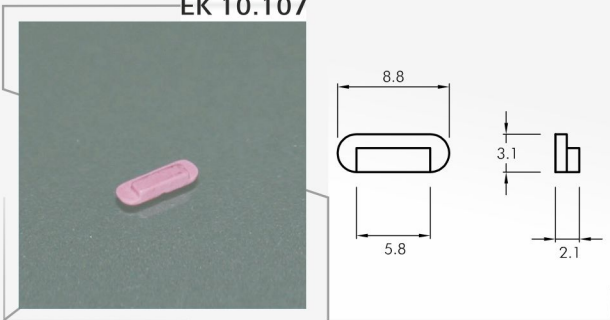

EK 10.108

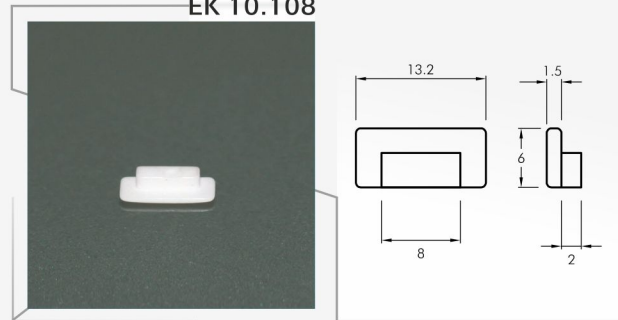

EK 10.109

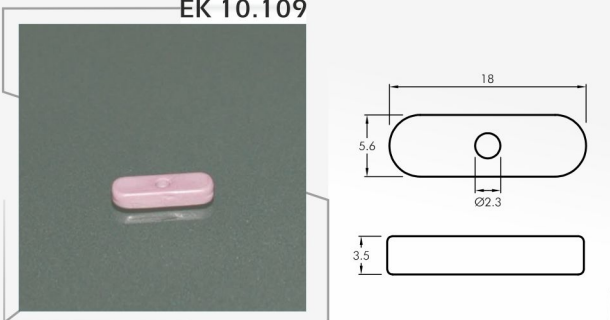

EK 10.110

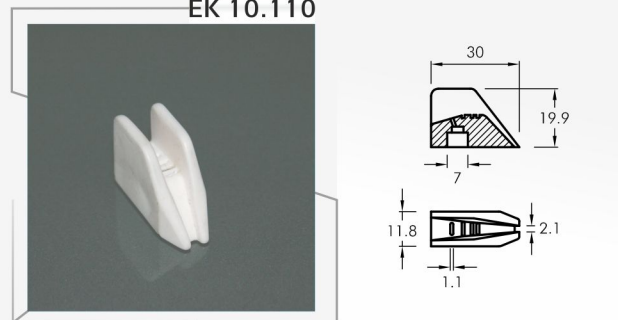

EK 10.111

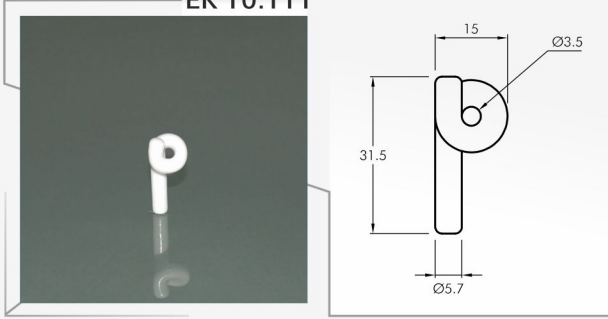

EK 10.112

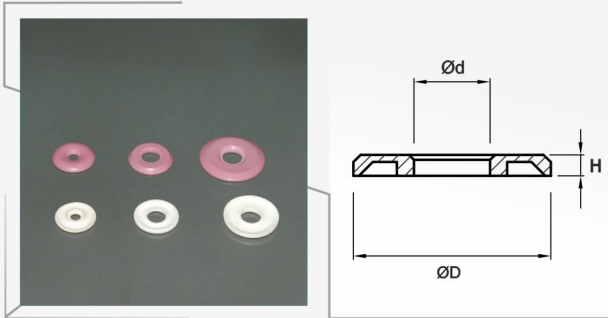
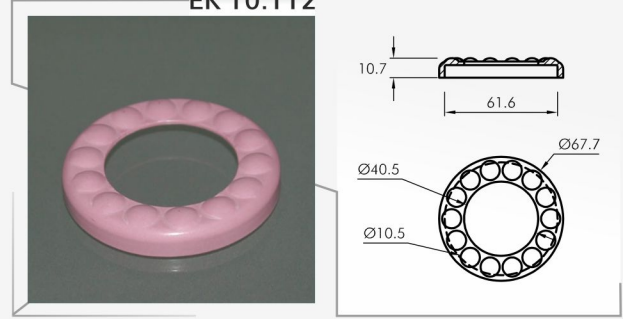

KOD NO	ØD	ØD1	Ød	H
EK.10.113	27.2	24	10.5	2.9
EK.10.235	25.1	20.8	10.3	3.3
EK.10.239	36.9	29	11	3.7
EK.10.289	26.1	21.5	8	4
EK.10.401	24.4	20.5	10	2.5
EK.10.403	29.5	23	10.8	4
EK.10.404	22	17.5	5.5	3.5
EK.10.430	27.8	23	9.5	3.1
EK.10.453	24.1	-	5.8	3.2

EK 10.114

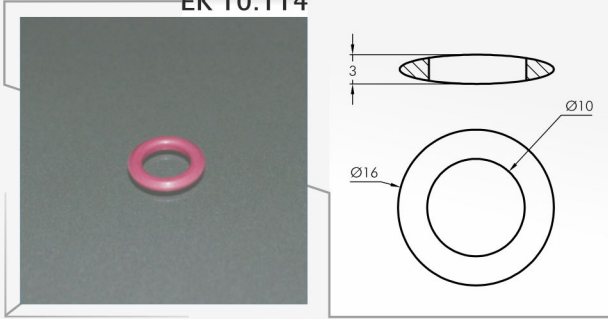

EK 10.115

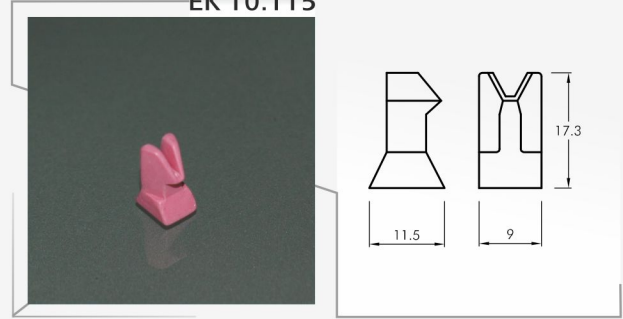

EK 10.116

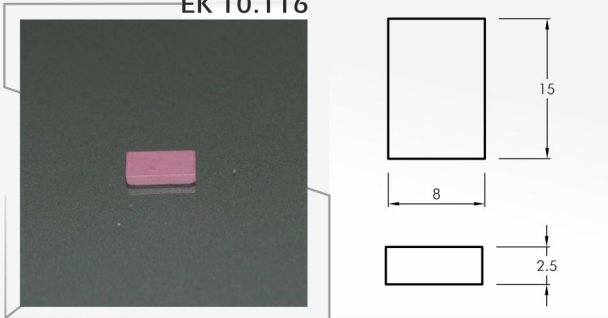

EK 10.117

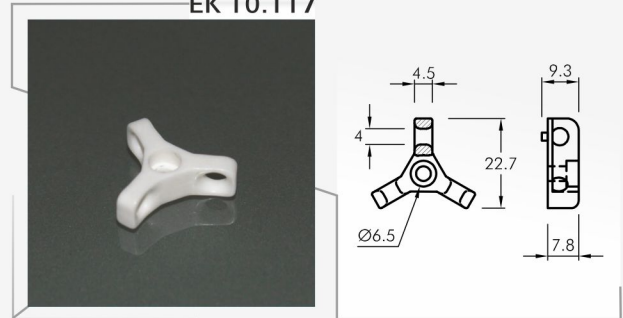

EK 10.118

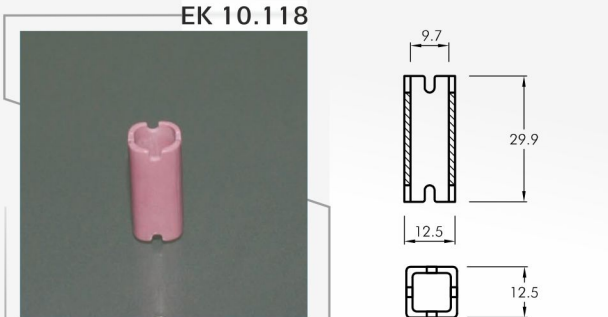

EK 10.119

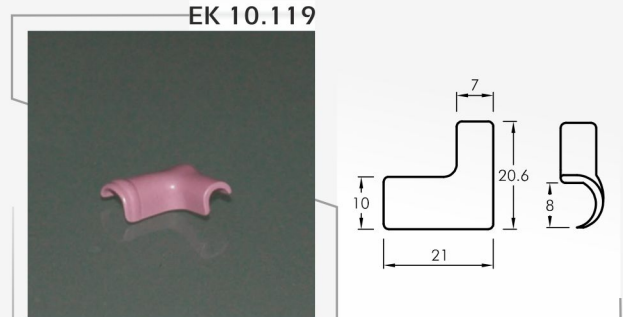

EK.10

EK 10.120

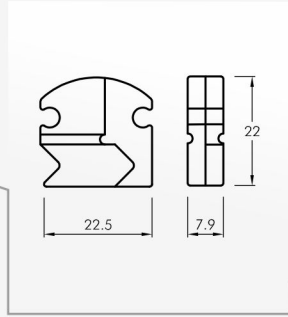
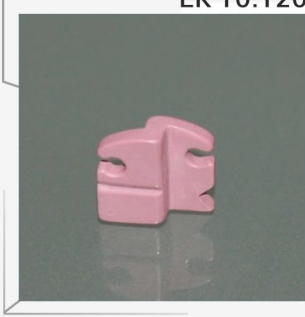

EK 10.121

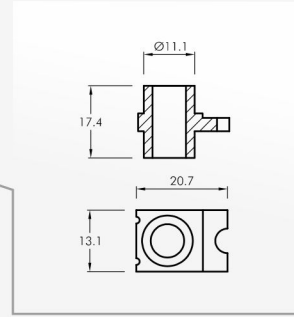
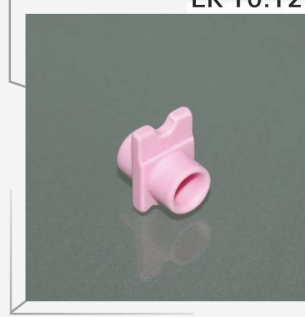

EK 10.122

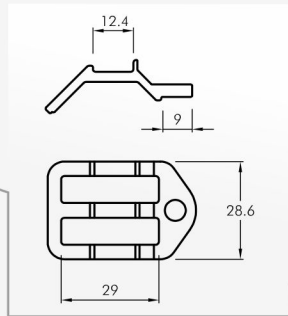
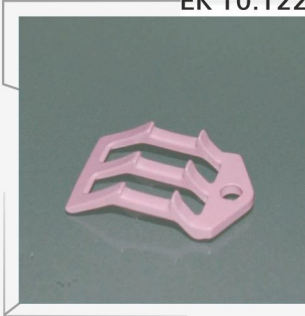

EK 10.123

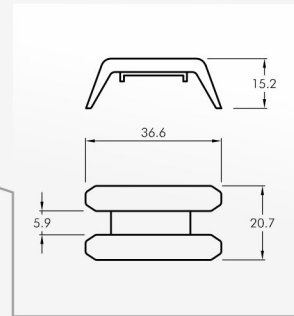

EK 10.124

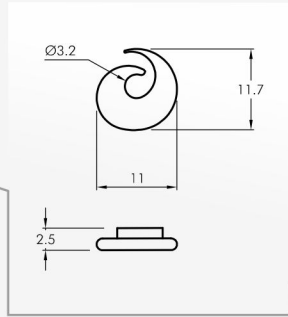
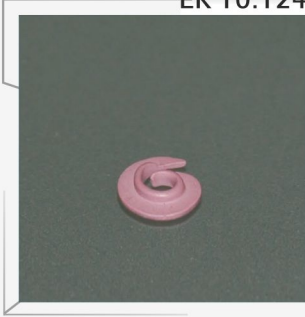

EK 10.125

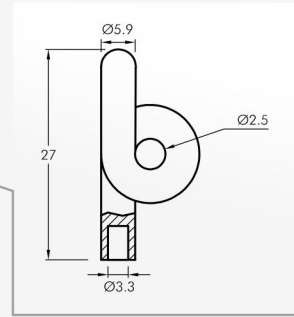

EK 10.126

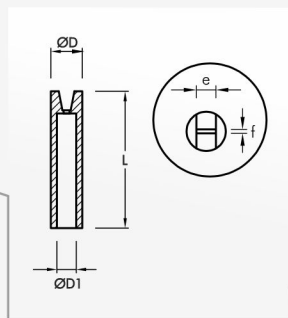
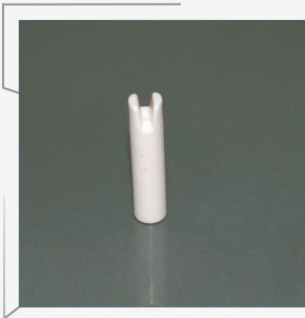
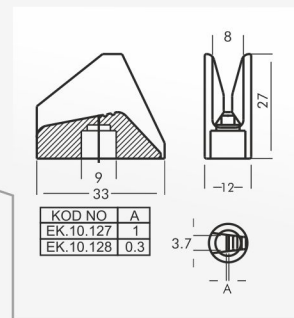
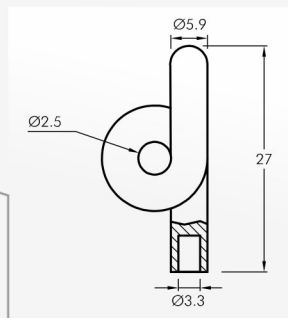
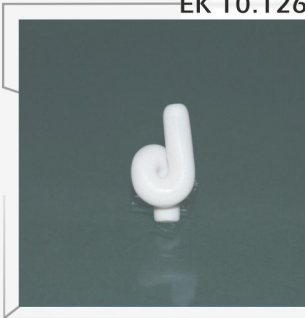

KOD NO	ØD	ØD 1	L	Ød	e	f
EK.10.129	9.8	6.1	43.2	-	1.5	0.6
EK.10.155	9.8	6.1	42.8	-	2.0	0.8
EK.10.185	9.9	6.2	43.6	-	3.6	0.8
EK.10.189	9.9	6.1	42.7	-	5.0	0.5
EK.10.388	11.8	9.0	19.0	0.6	-	-
EK.10.399	9.8	3.8	37.6	0.8	-	-

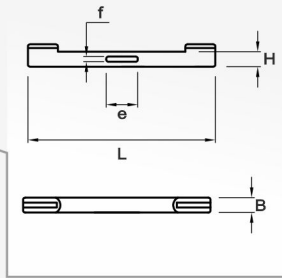

KOD NO	L	H	B	e	f
EK.10.130	109.0	10.0	9.5	13.0	2.0
EK.10.136	108.2	11.3	9.5	13.2	2.5
EK.10.172	92.9	8.0	7.5	11.8	1.8
EK.10.328	107.5	8.9	9.5	12.9	1.8
EK.10.438	123.0	6.5	9.5	30.0	1.2

EK 10.131

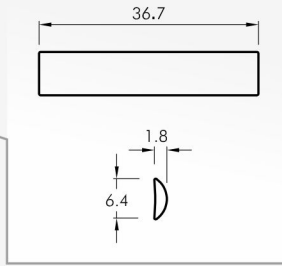
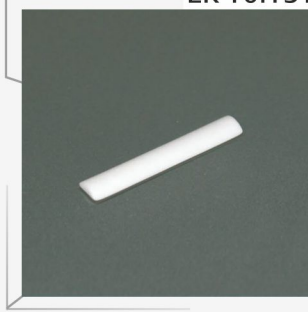

EK 10.132

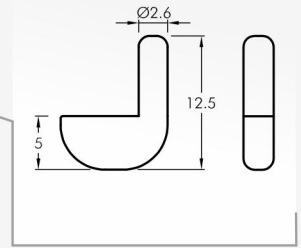
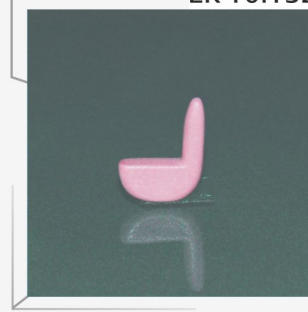

EK 10.133

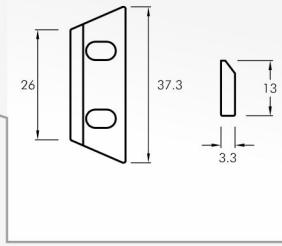
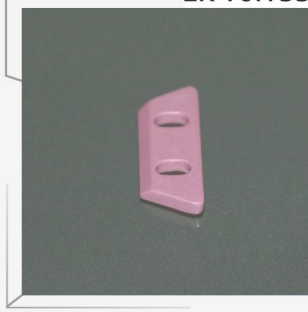

EK 10.134

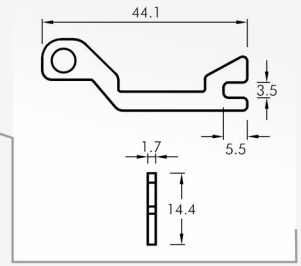
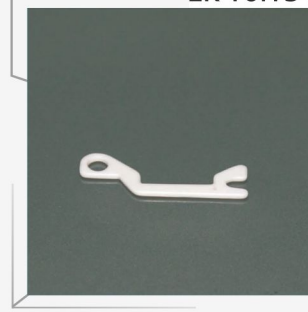

EK 10.135

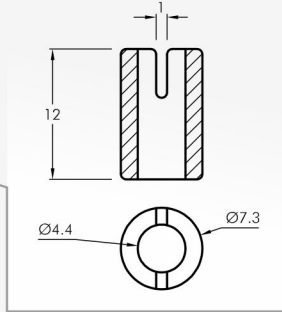
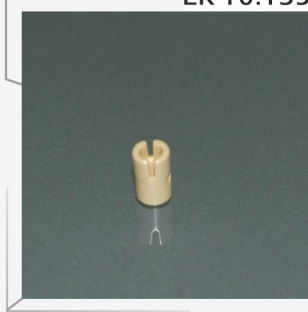

EK 10.137

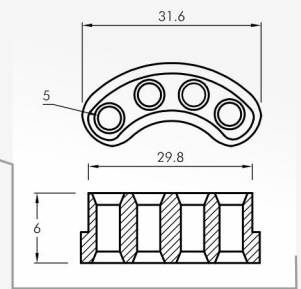
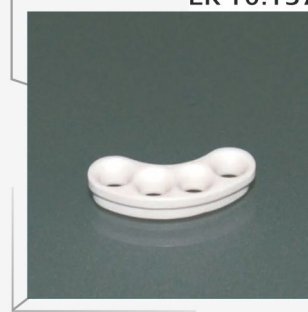

EK 10.138

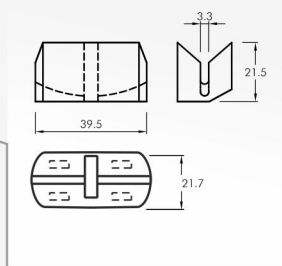

EK 10.139

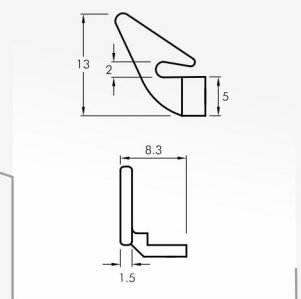

EK.10

EK 10.140

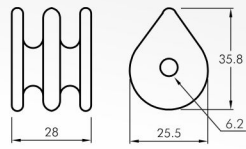
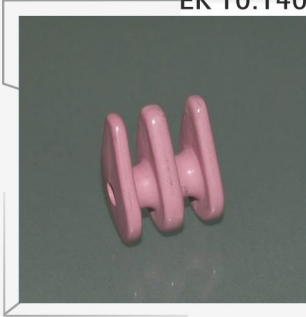

EK 10.141

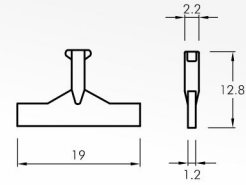
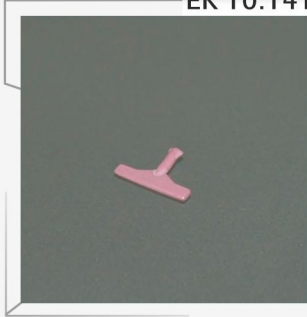

EK 10.142

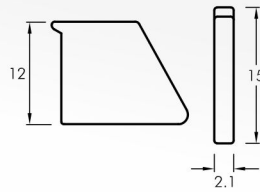
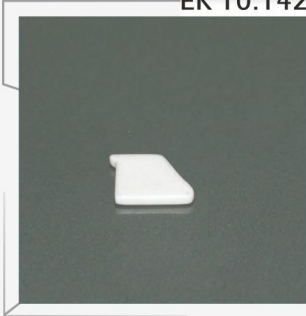

EK 10.143

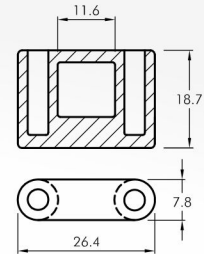
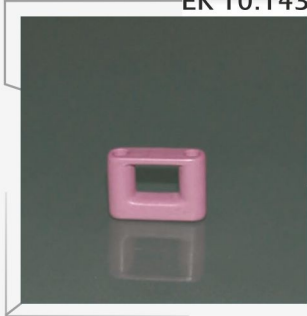

EK 10.144

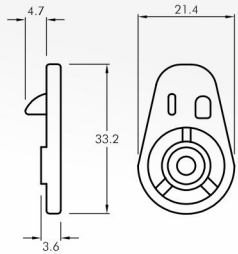

EK 10.145

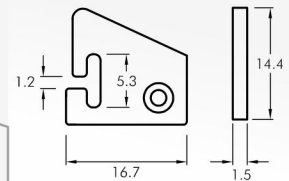
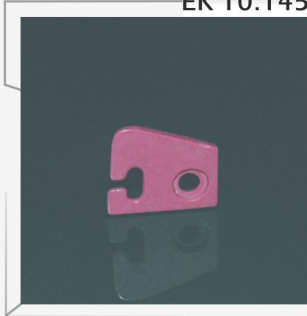

EK 10.146

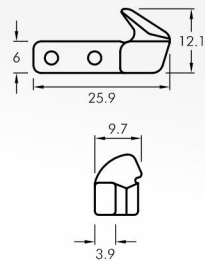
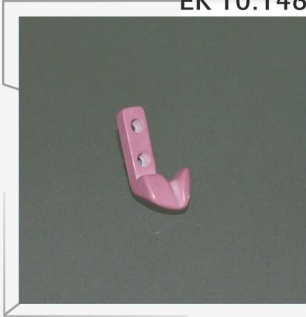

EK 10.147

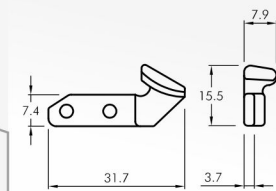

EK 10.148

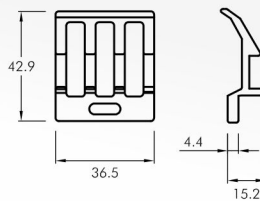
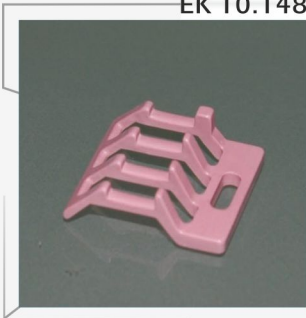

EK 10.149

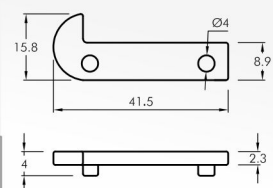

EK 10.150

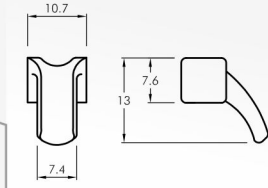
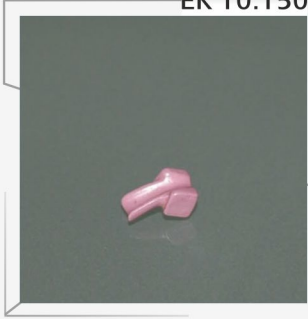

EK 10.154

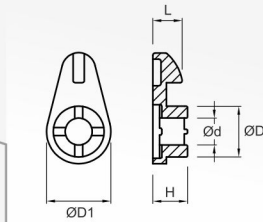
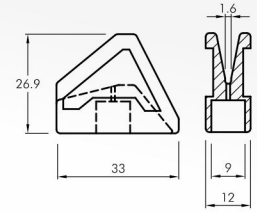

KOD NO	ØD	ØD1	Ød	H	L
EK.10.151	12.7	16.1	8.2	12.5	30
EK.10.152	11.5	14.3	6.1	7.8	24.5
EK.10.153	8.1	11.4	4.4	6	20
EK.10.320	8.5	9.7	4.3	4.5	17
EK.10.393	12.8	16.8	8.3	17	34.9
EK.10.394	12.8	17	8.2	15.5	32.2

EK 10.156

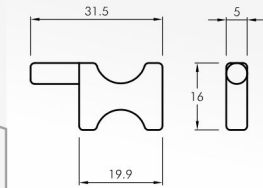
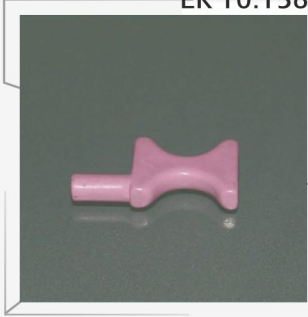

EK 10.157

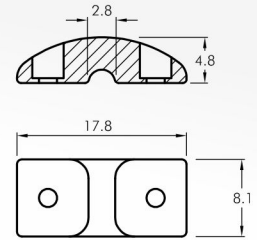
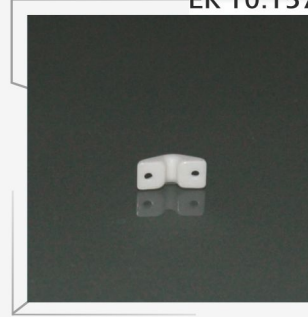

EK 10.158

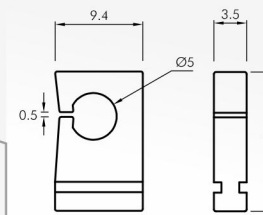
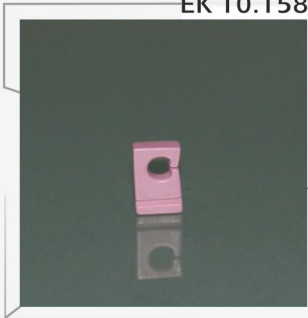

EK 10.159

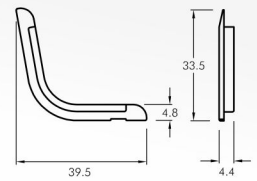
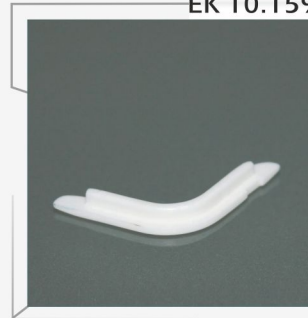

EK 10.160

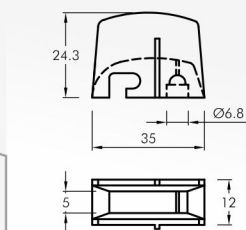
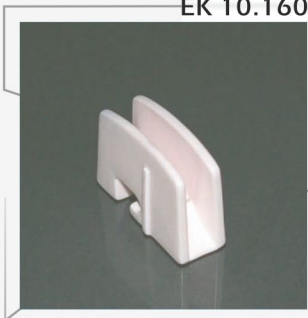

EK 10.161

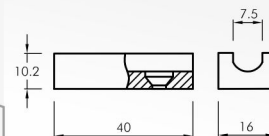

EK.10

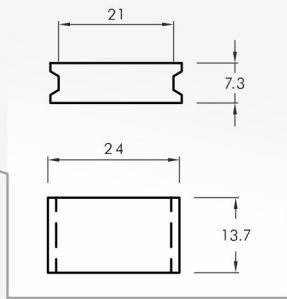
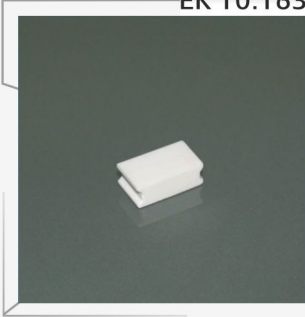
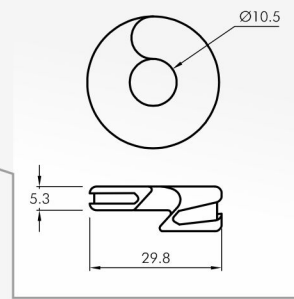
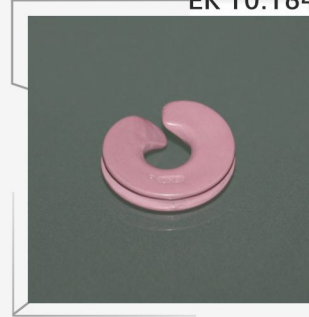
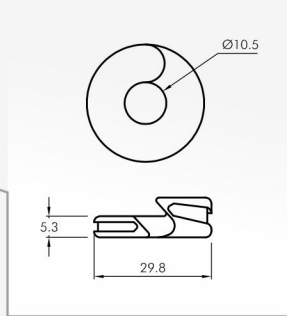
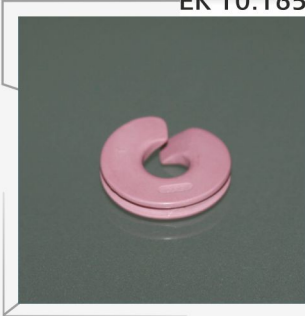
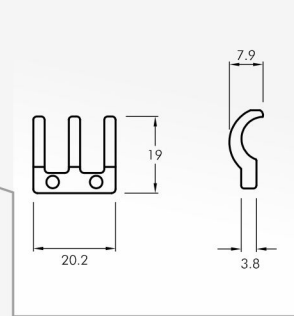
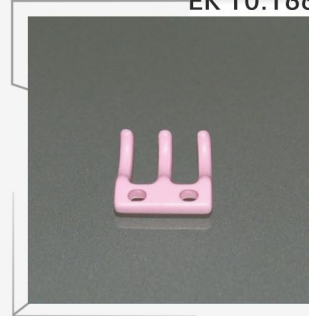
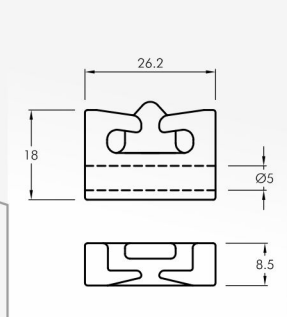
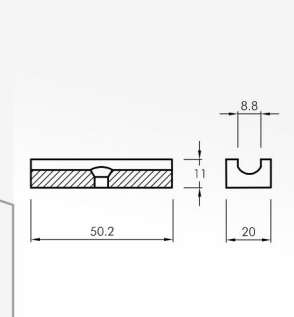
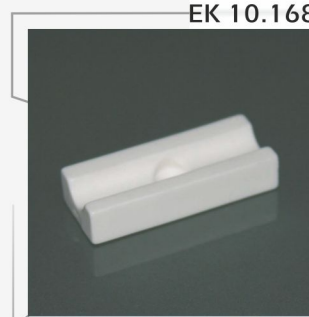
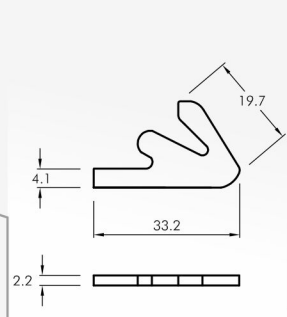
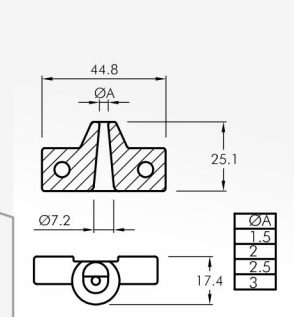
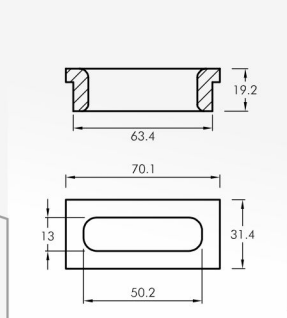
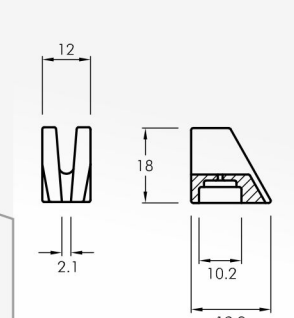
EK 10.163

EK 10.164

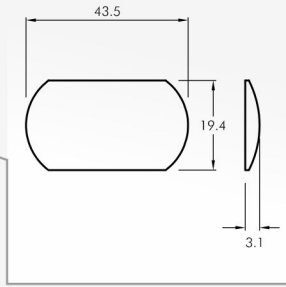
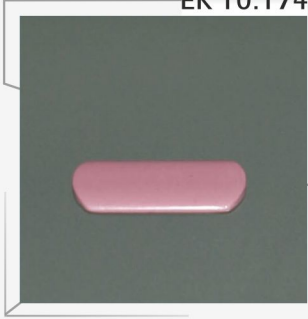
EK 10.165

EK 10.166

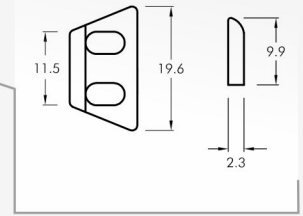
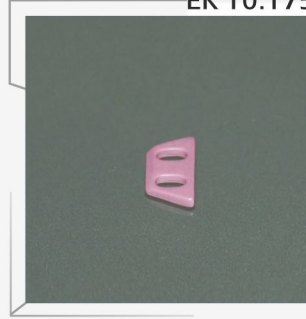
EK 10.167

EK 10.168

EK 10.169

EK 10.170

EK 10.171

EK 10.173

EK 10.174



EK 10.175



EK 10.176

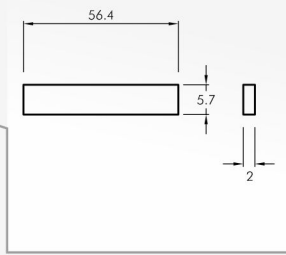
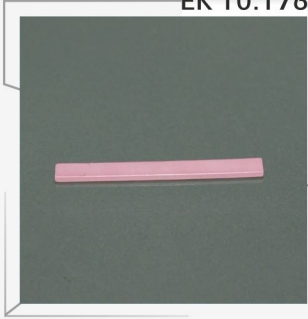

EK 10.177

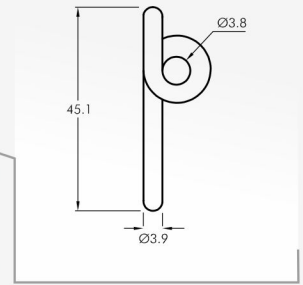
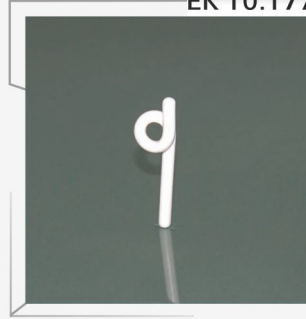

EK 10.178

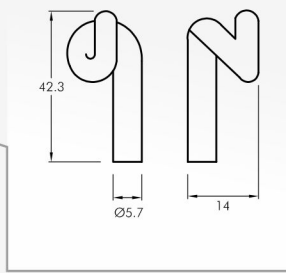

EK 10.179

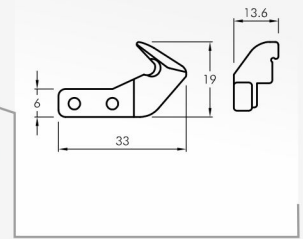

EK 10.180

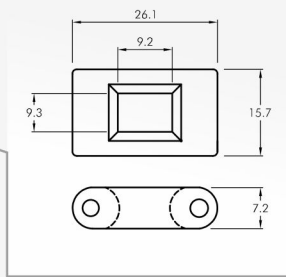
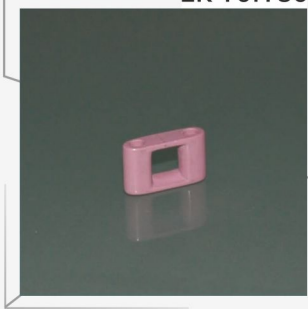

EK 10.181

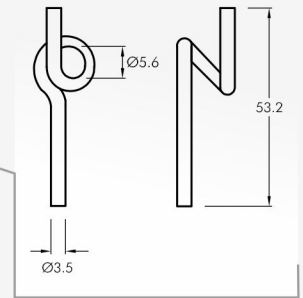
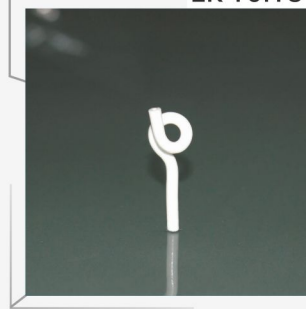

EK 10.182

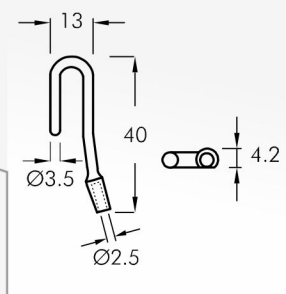
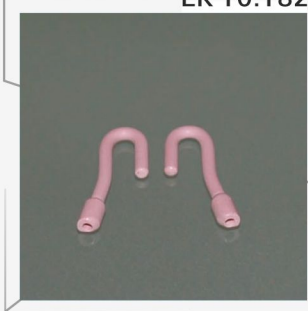

EK 10.183

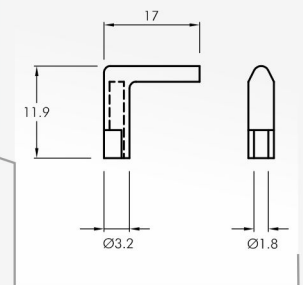
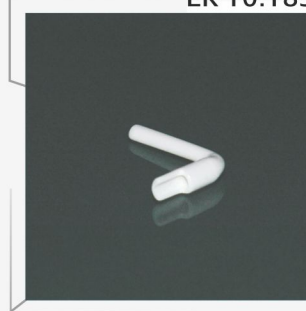

EK.10

EK 10.184

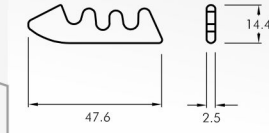
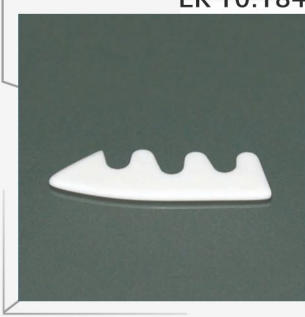

EK 10.186

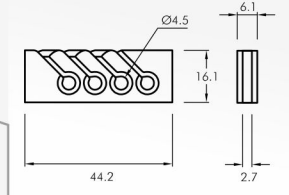
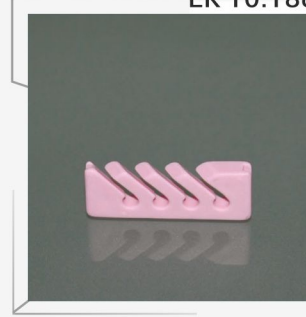

EK 10.187

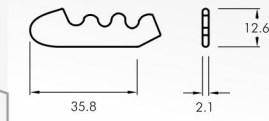
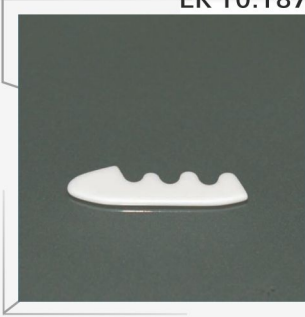

EK 10.188

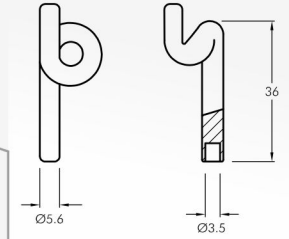
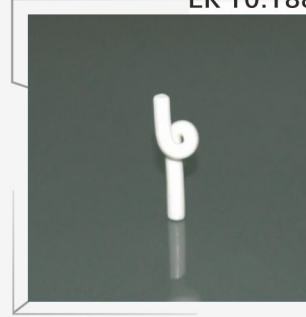

EK 10.190

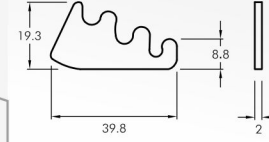
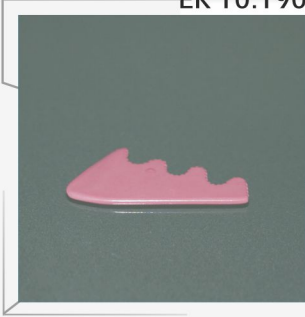

EK 10.192

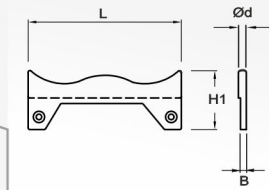
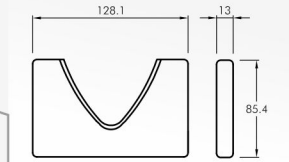

KOD NO	L	H	H1	Ød	B
EK.10.191	148.7	35.4	32.8	3	2.8
EK.10.231	25.1	30.5	28.1	4.3	3.3

EK 10.193

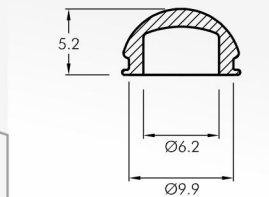
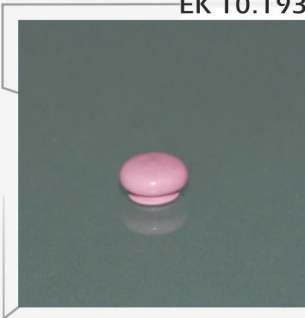

EK 10.194

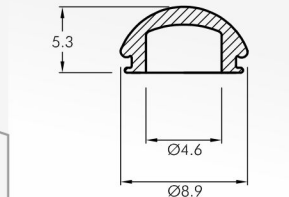

EK 10.195

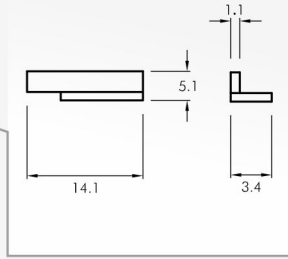
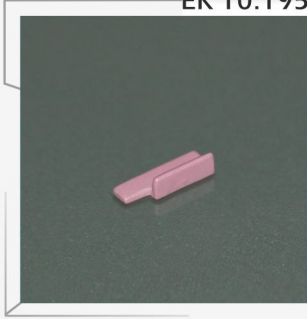

EK 10.196

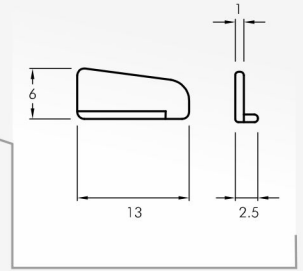
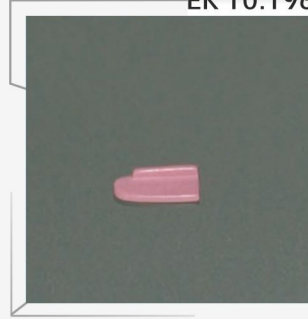

EK 10.197

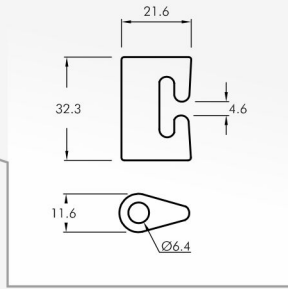
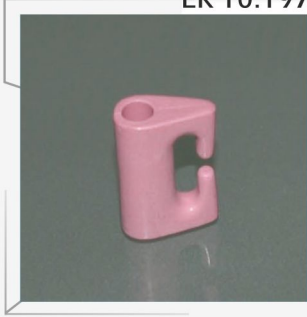

EK 10.198

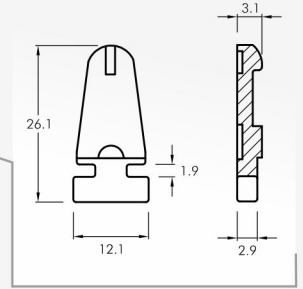

EK 10.199

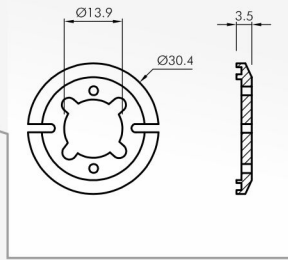
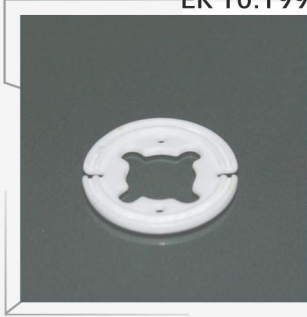

EK 10.200

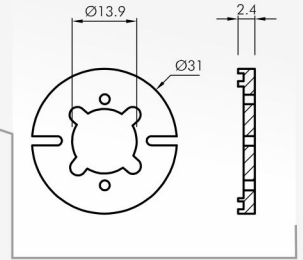
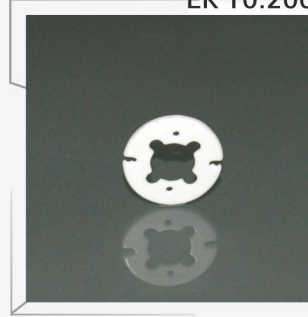

EK 10.201

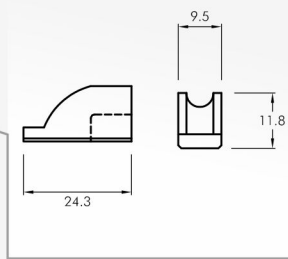
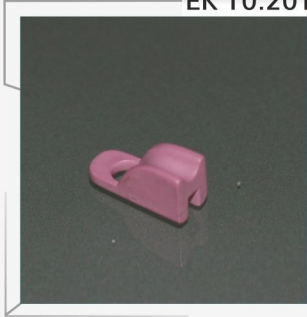

EK 10.202

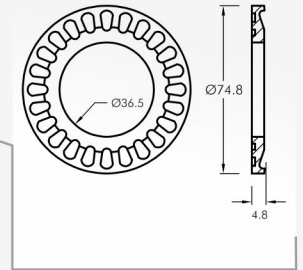
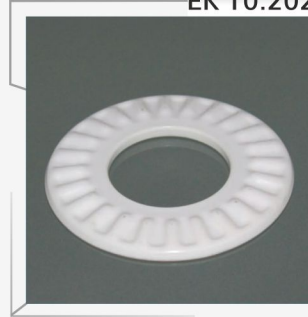

EK.10.203

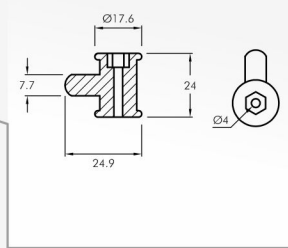

EK 10.204

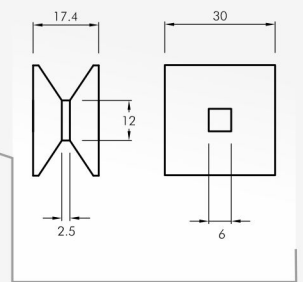
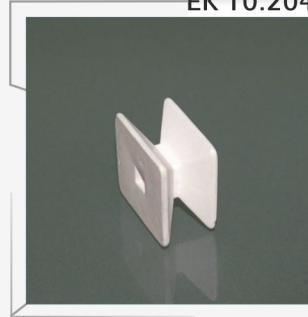

EK.10

EK 10.205

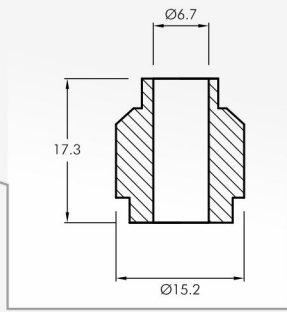

EK 10.206

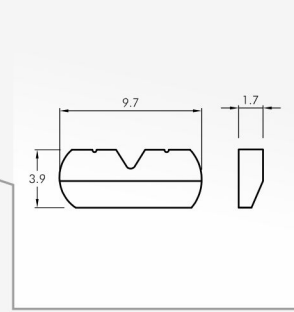

EK 10.207

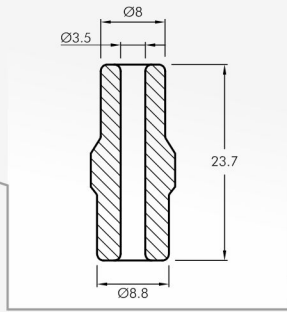
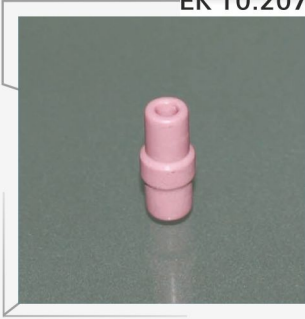

EK 10.208

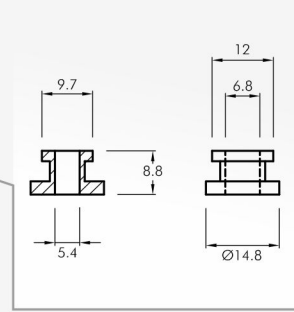

EK 10.209

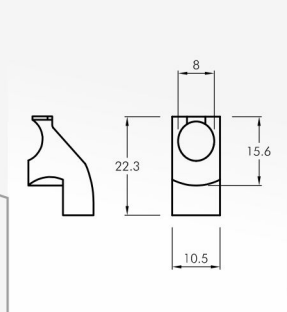

EK 10.210

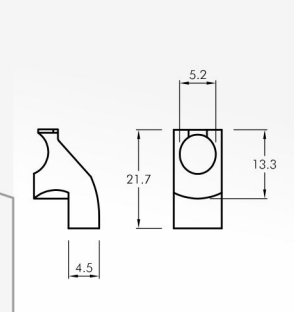

EK 10.211

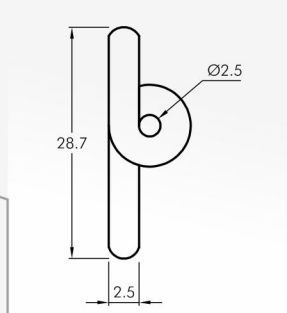
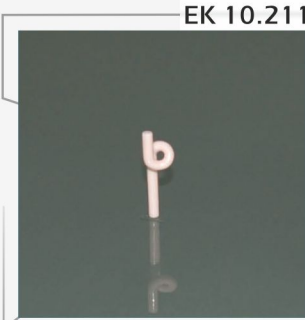

EK 10.212

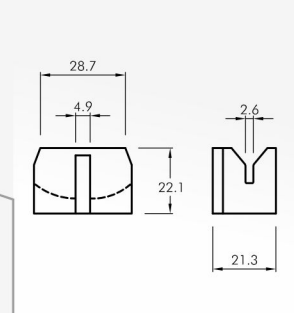
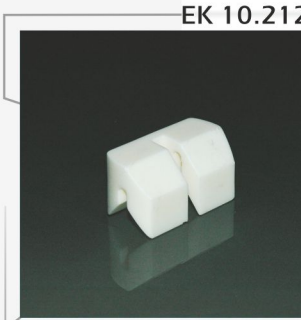

EK 10.213

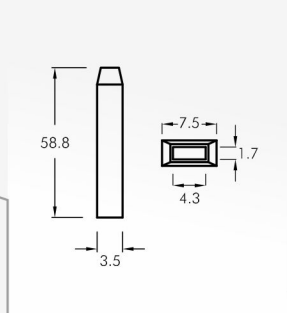
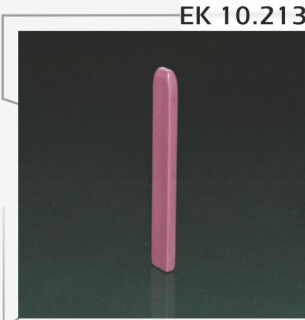

EK 10.214

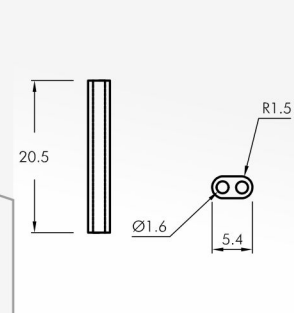

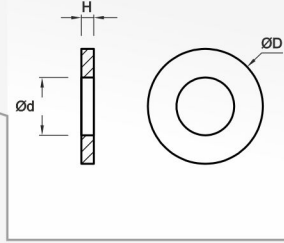
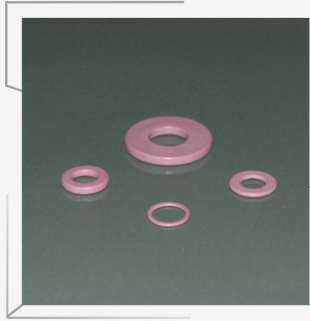

KOD NO	ØD	Ød	H
EK.10.215	18	9.1	2.1
EK.10.216	18	9.2	2.9
EK.10.217	34.5	15.2	3.9
EK.10.294	15.5	12	1.2
EK.10.307	31.4	20.6	3.2
EK.10.310	25.8	17.2	4
EK.10.321	17.7	9	1.1
EK.10.387	19.9	12.7	2.5
EK.10.397	19.8	14.3	3.4

EK 10.218

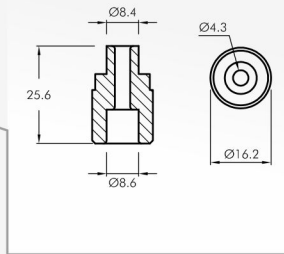
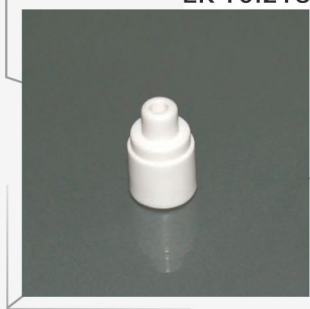

EK 10.219

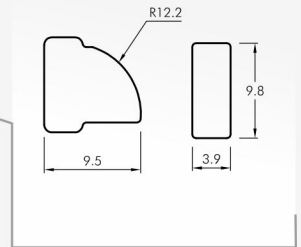

EK 10.220

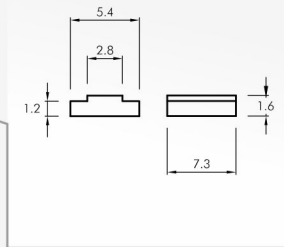
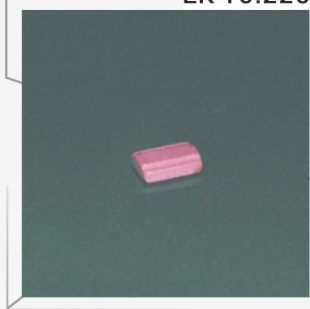

EK 10.221

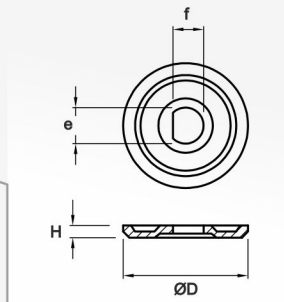
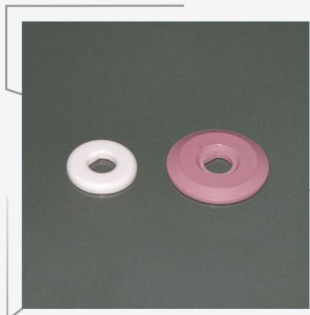
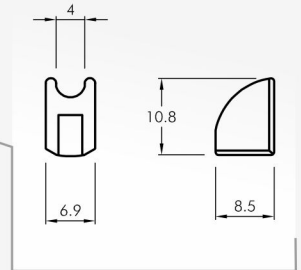
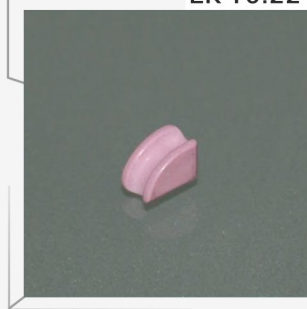

KOD NO	ØD	ØD1	e	f	H
EK.10.222	35.5	27.6	9.9	9	4
EK.10.379	24.6	21.8	9.9	9.2	3.5

EK 10.223

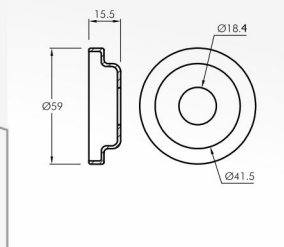

EK 10.224

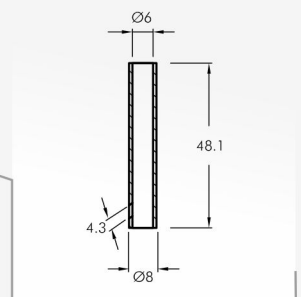

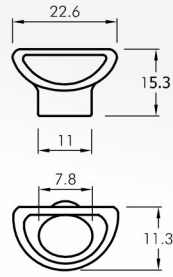
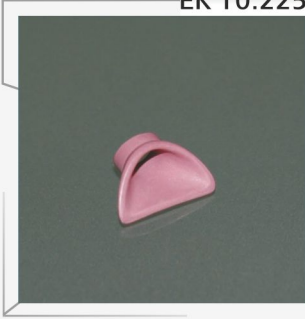
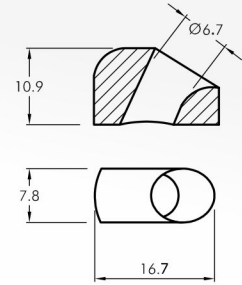
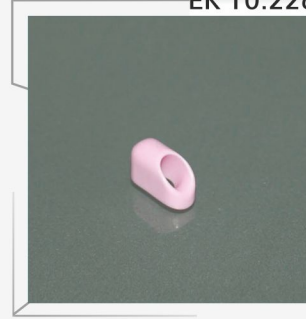
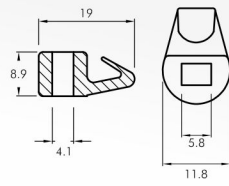
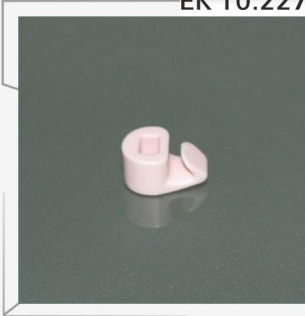
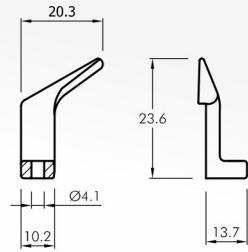
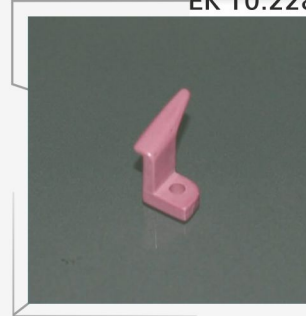
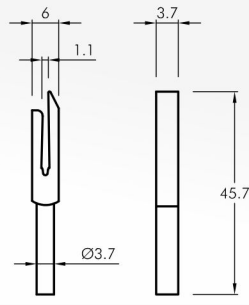
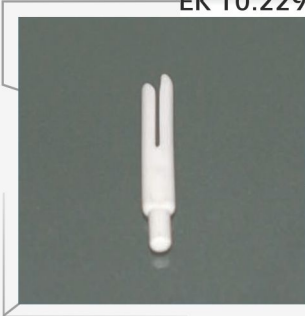
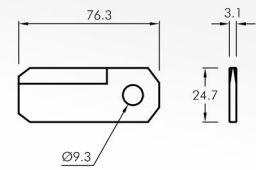
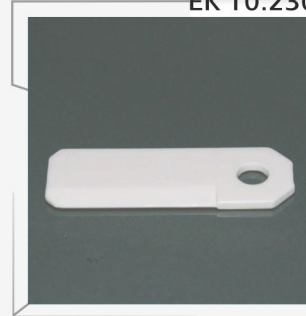
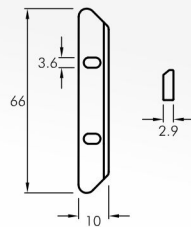
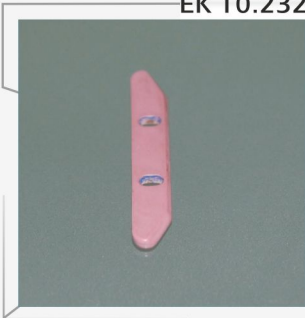
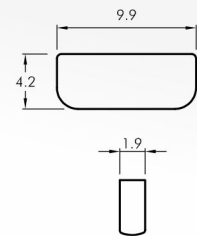
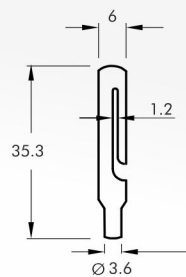
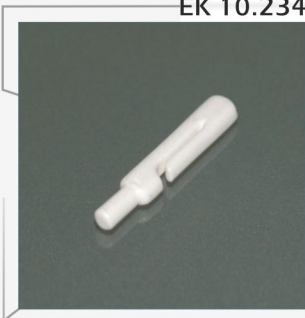
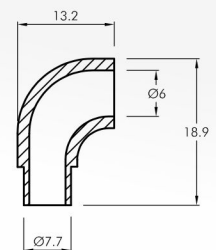
EK 10.225

EK 10.226

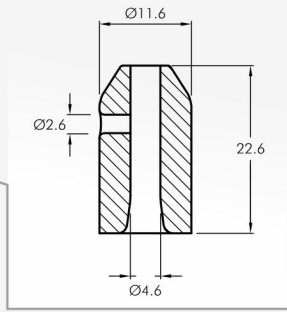
EK 10.227

EK 10.228

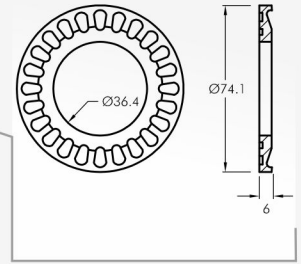
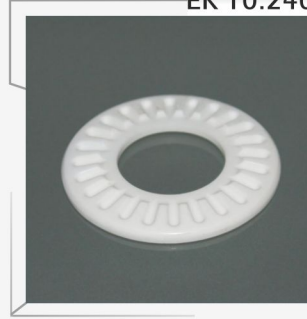
EK 10.229

EK 10.230

EK 10.232

EK 10.233

EK 10.234

EK 10.237

EK 10.238



EK 10.240



EK 10.241

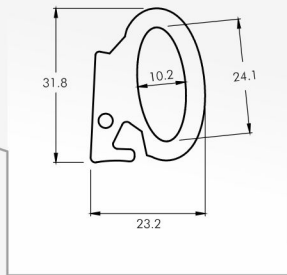

EK 10.242

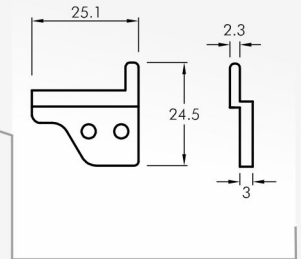
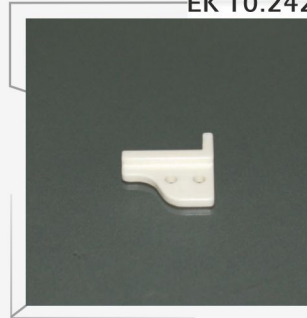

EK 10.243

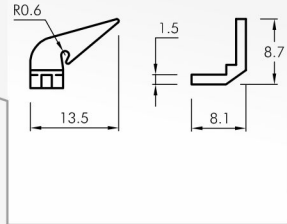
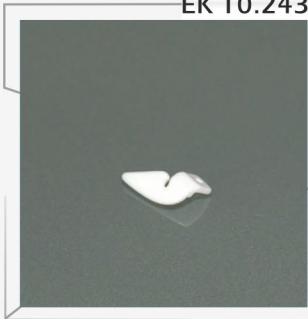

EK 10.244

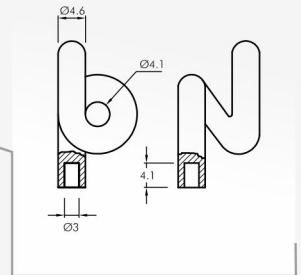
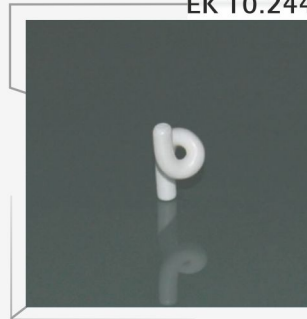

EK 10.245

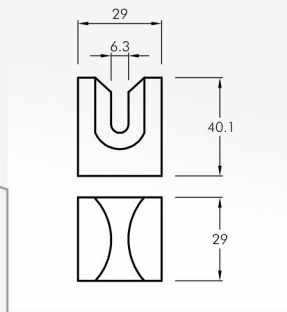

EK 10.246

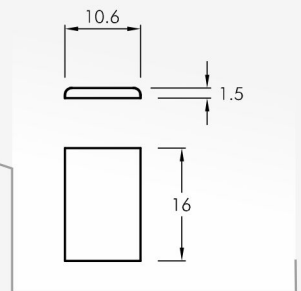
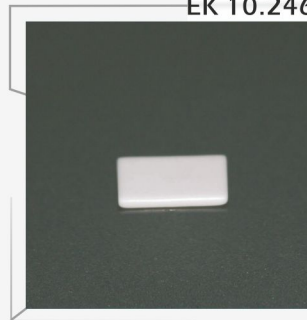

EK 10.247

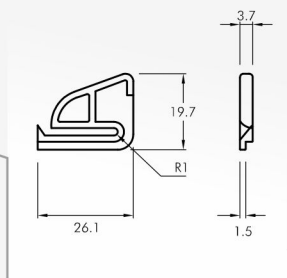
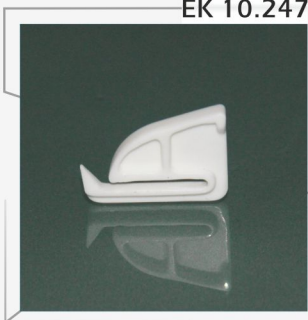

EK 10.248

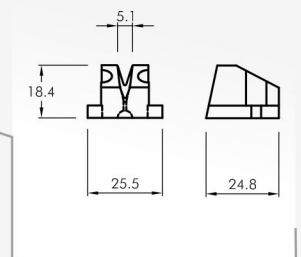
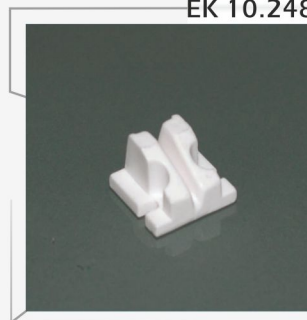

EK.10

EK 10.249

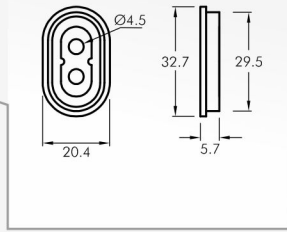

EK 10.250

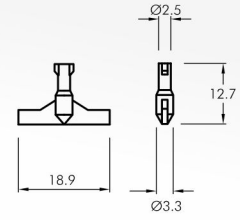

EK 10.251

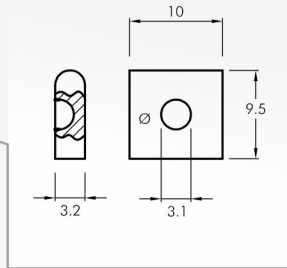
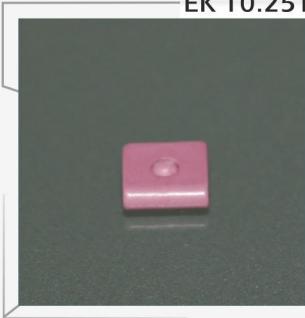

EK 10.253

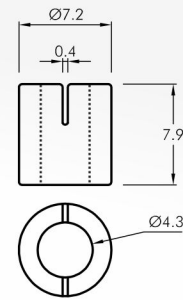
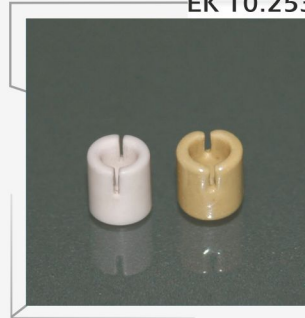

EK 10.254

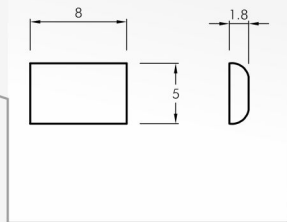

EK 10.255

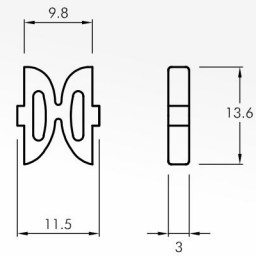
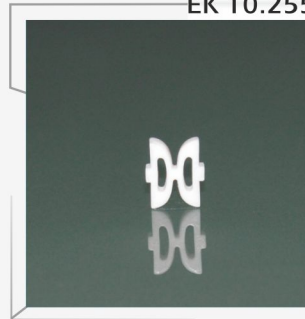

EK 10.256

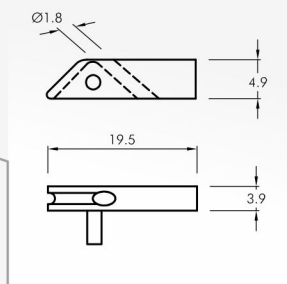

EK 10.257

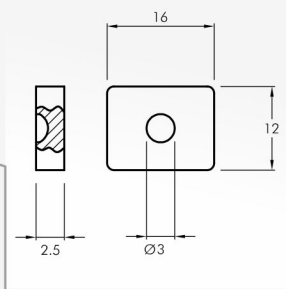
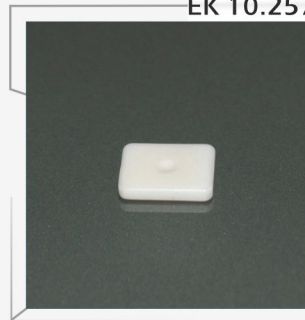

EK 10.258

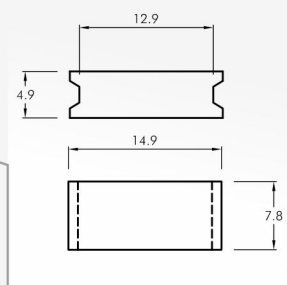
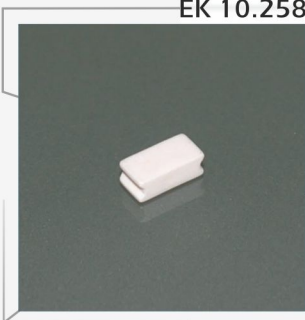

EK 10.259

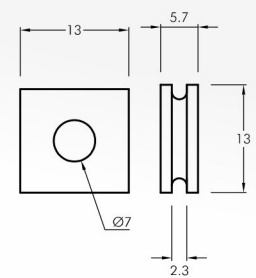
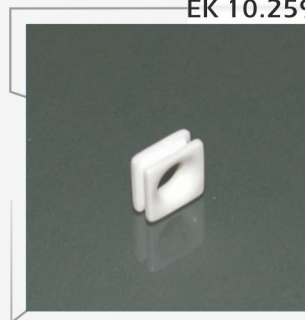

EK 10.260

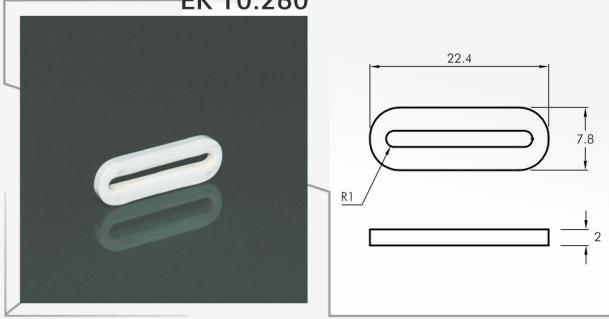

EK 10.261

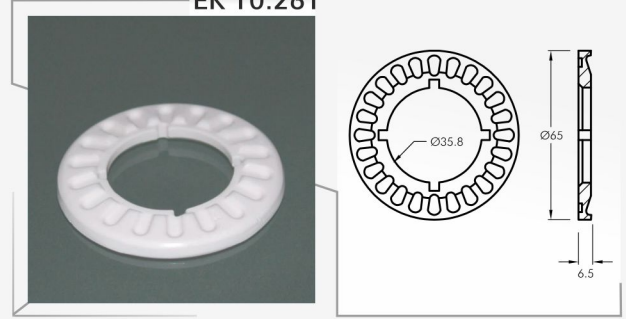

EK 10.262

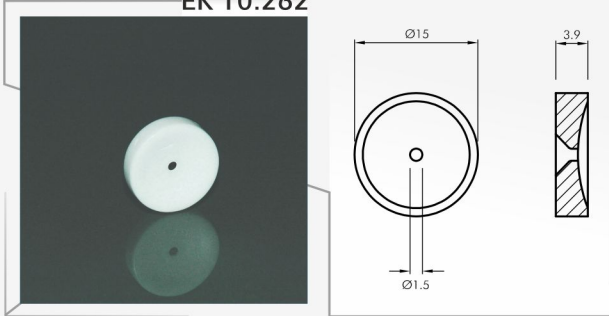

EK 10.263

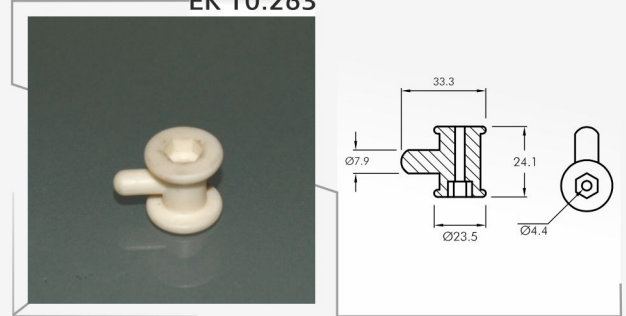

EK 10.264

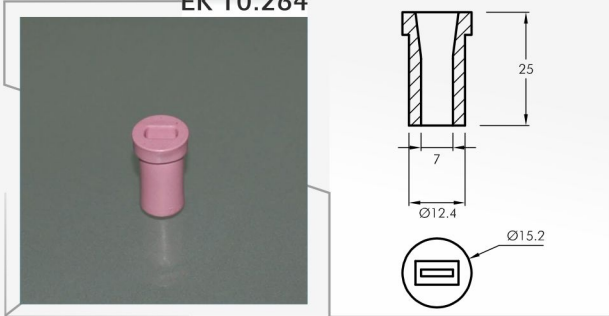

EK10.265

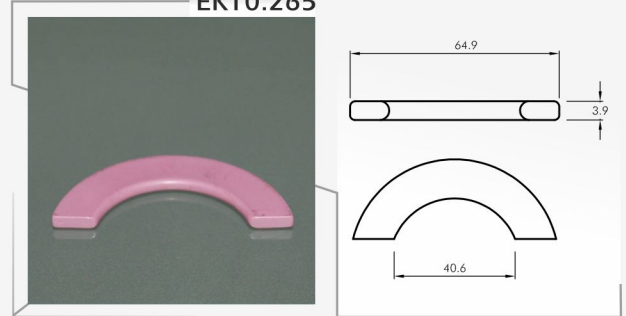

EK 10.266

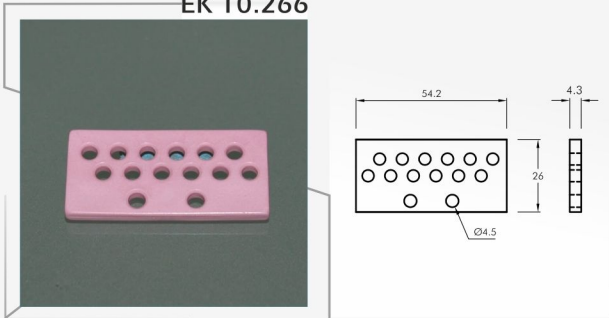

EK 10.267

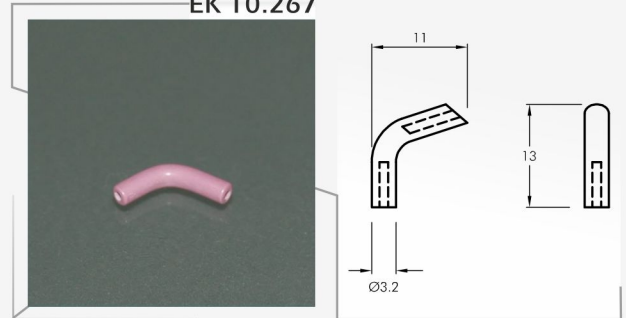

EK 10.268

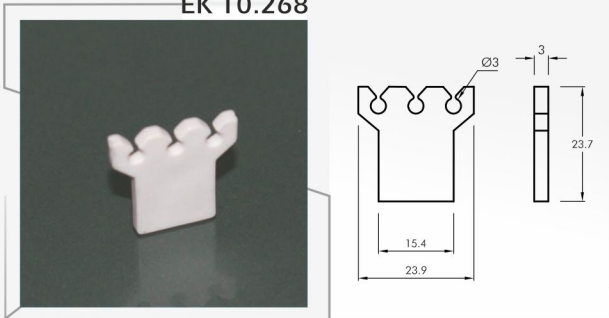

EK 10.269

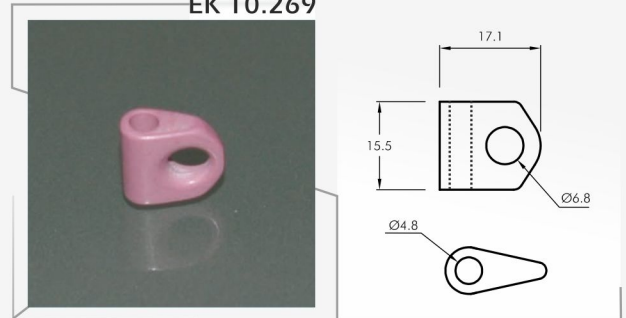

EK 10.270

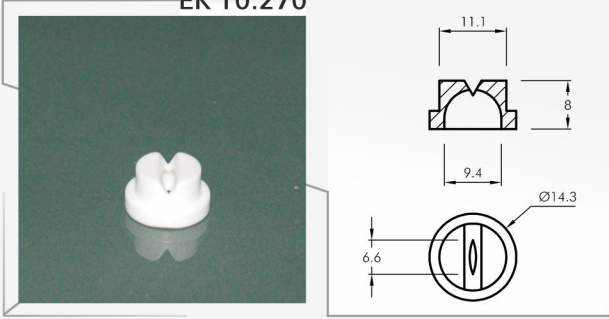

EK 10.271

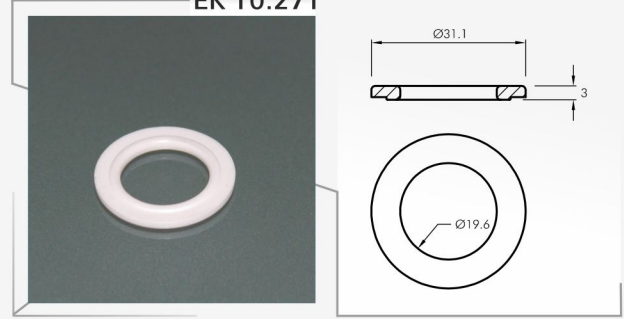

EK 10.272

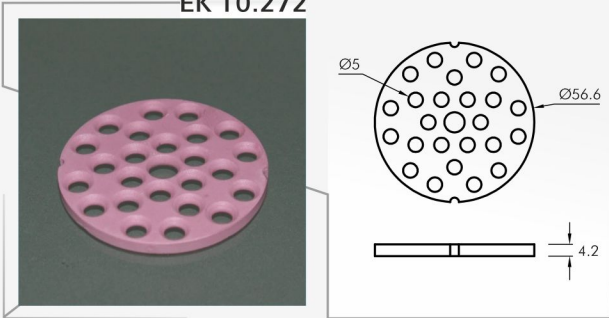

EK 10.273

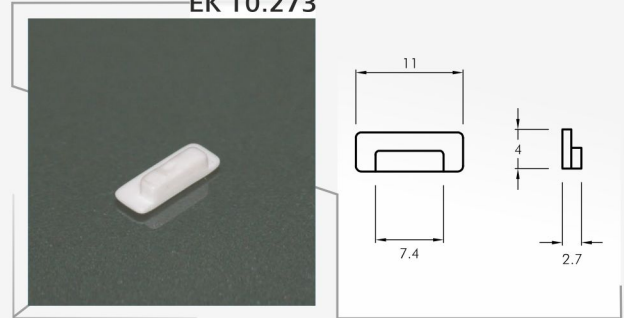

EK 10.274

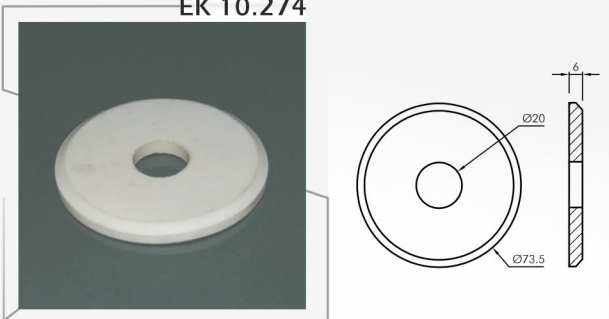

EK 10.275

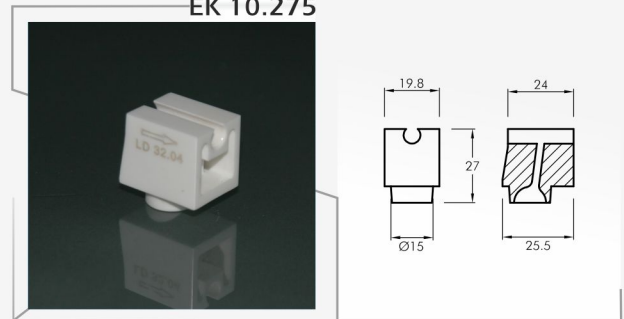

EK 10.276

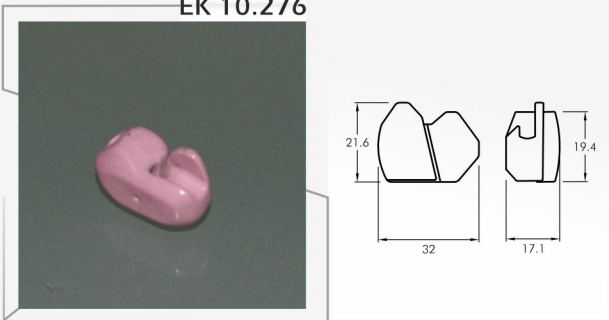

EK 10.277

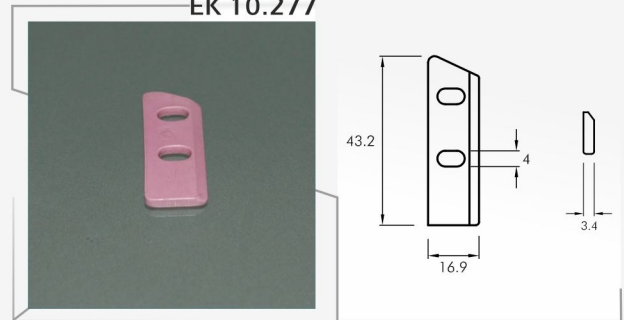

EK 10.278

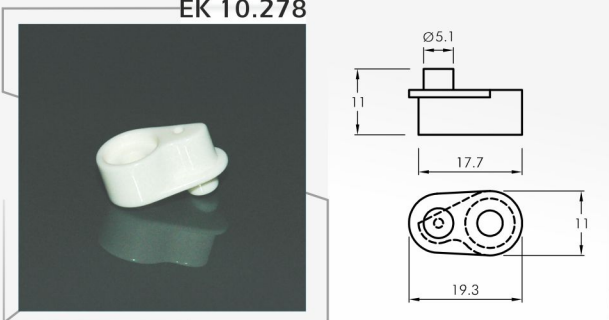

EK 10.279

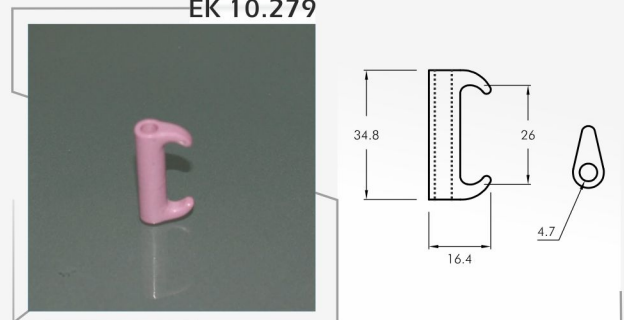

EK 10.280

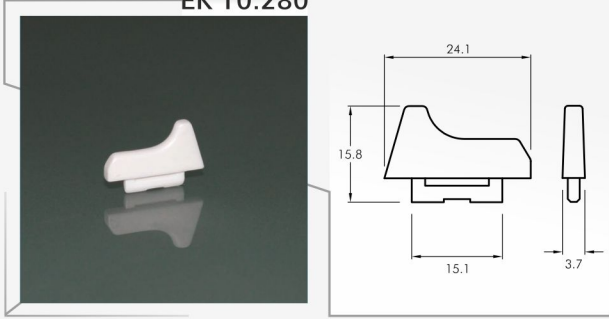

EK 10.281

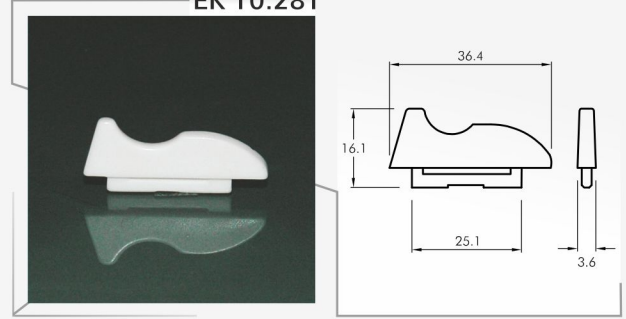

EK 10.282

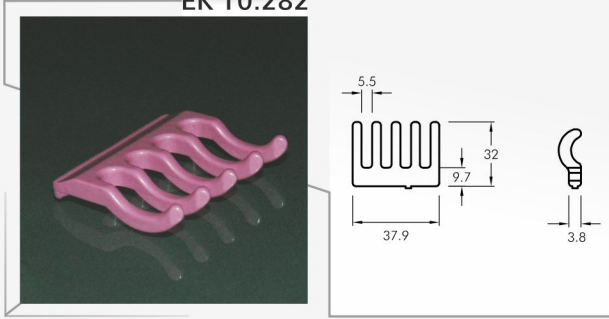

EK 10.283

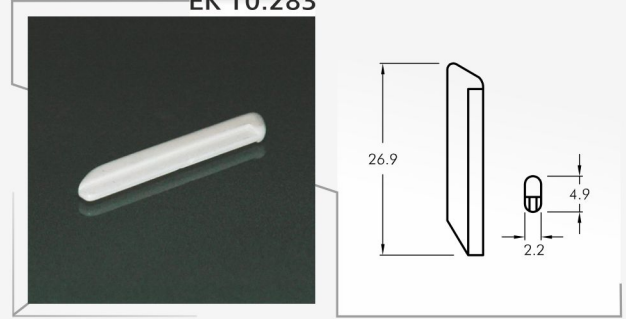

EK 10.284

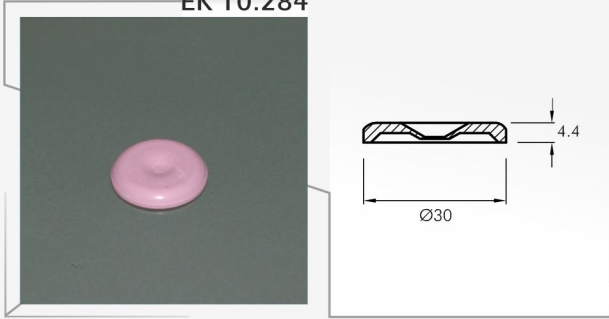

EK 10.285

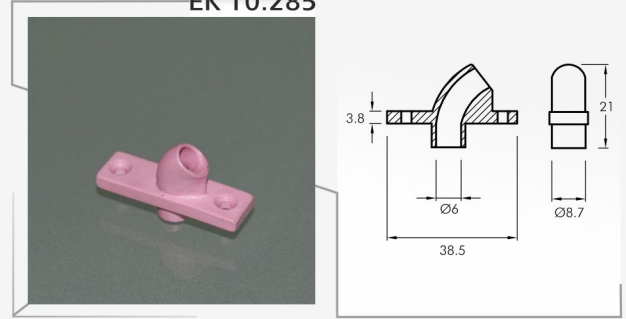

EK 10.286

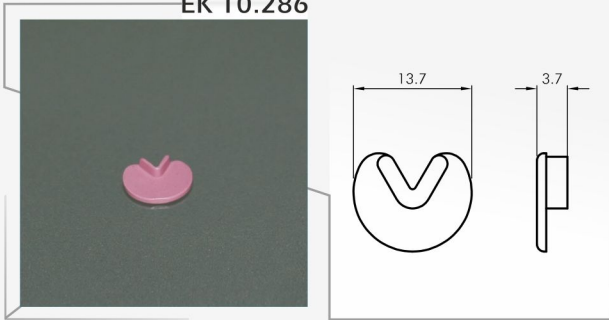

EK 10.287

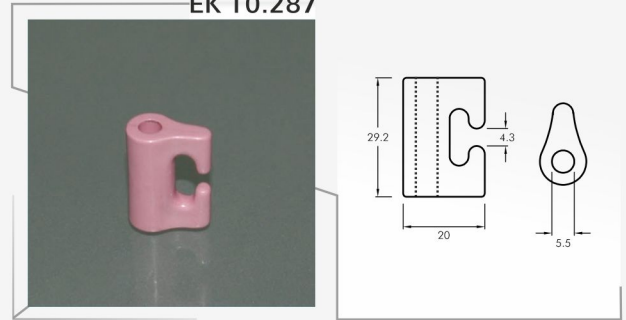

EK 10.288

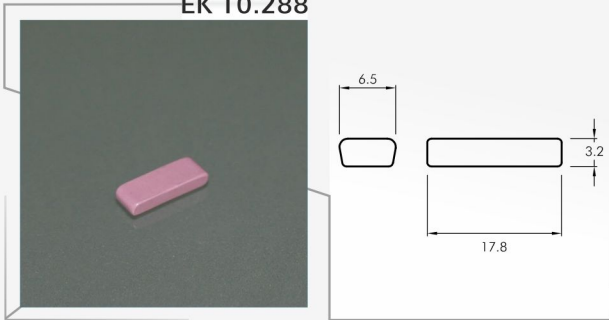

EK 10.290

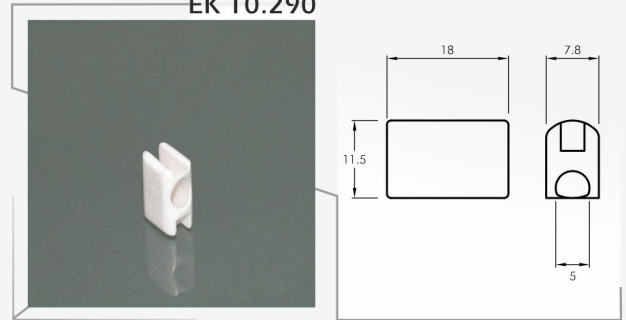

EK.10

EK 10.291

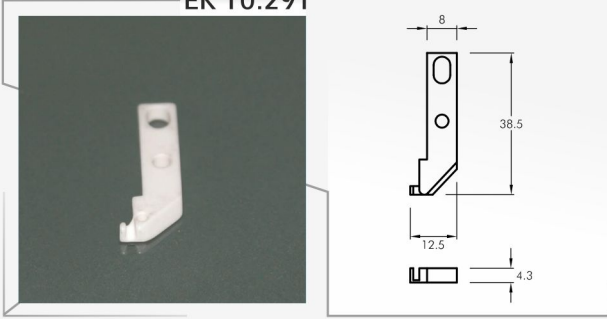

EK 10.292

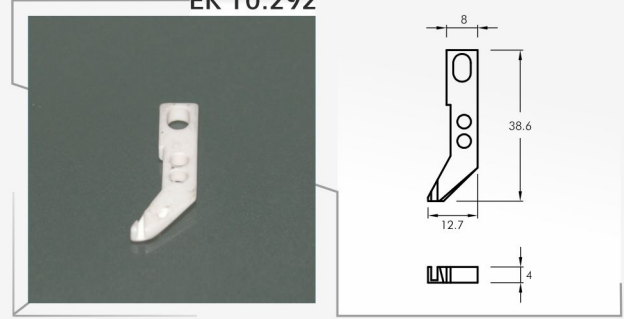

EK 10.293

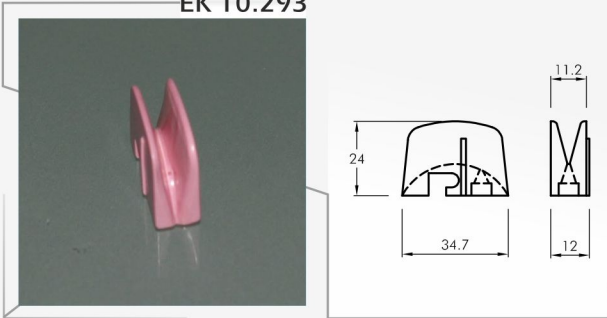

EK 10.295

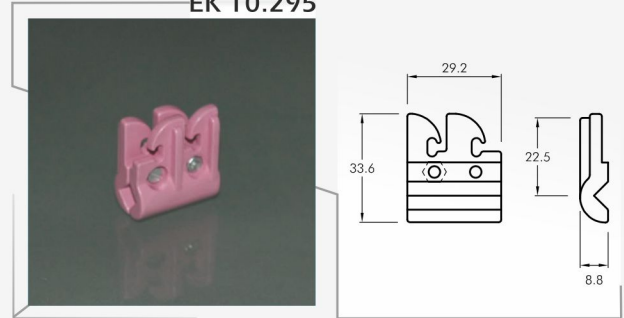

EK 10.296

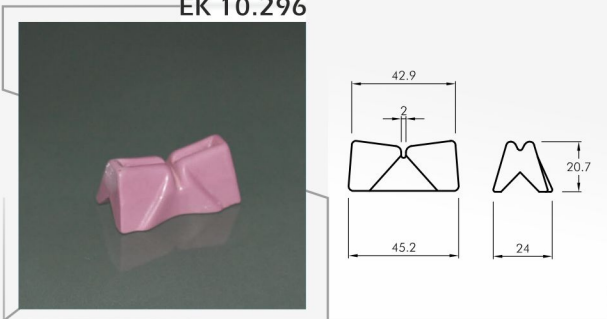

EK 10.297

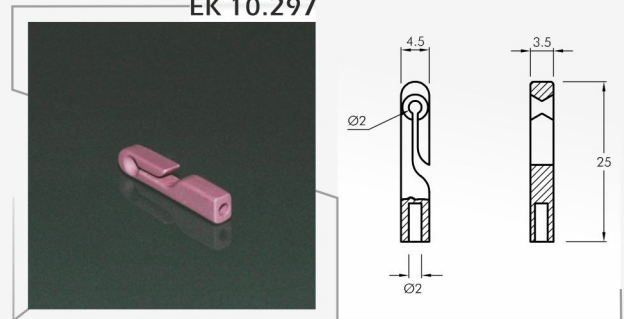

EK 10.298

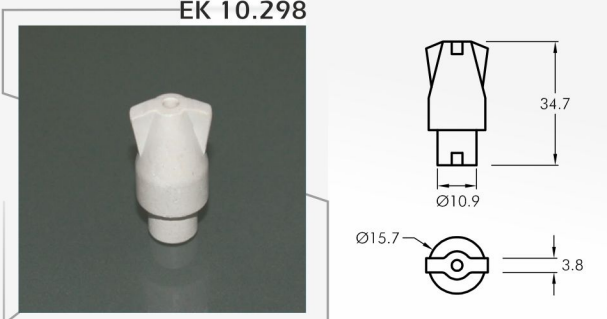

EK 10.299

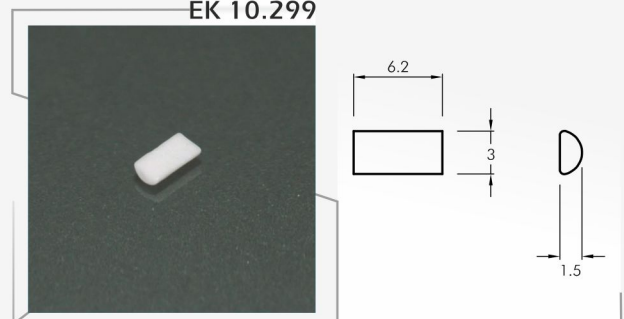

EK 10.300

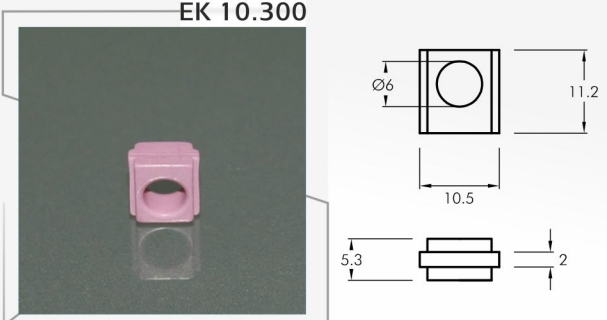

EK 10.301

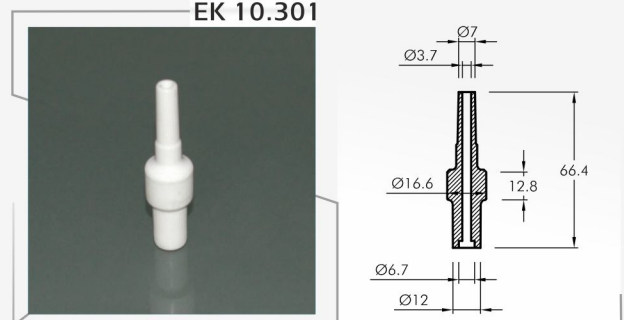

EK 10.302

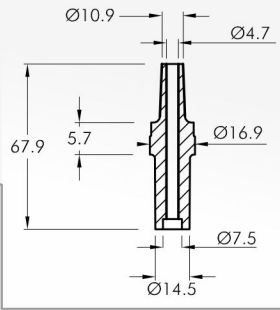
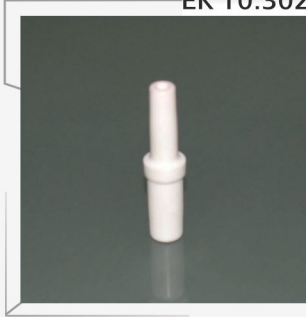

EK 10.305

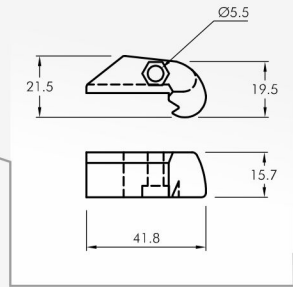

EK 10.306

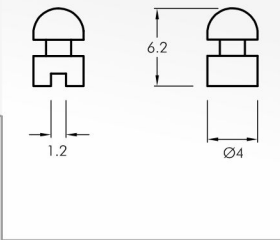

EK 10.308

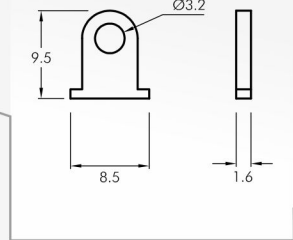
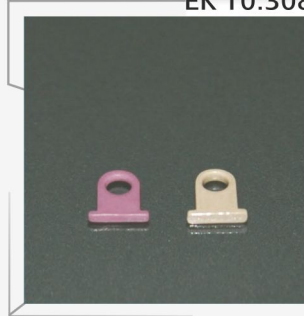

EK 10.304

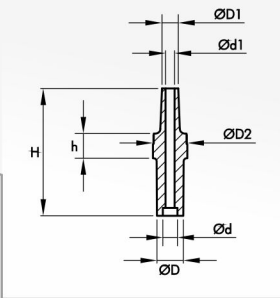

KOD NO	ØD	ØD1	ØD2	Ød	Ød1	H	h
EK.10.303	14.3	10.3	18	7.5	4.7	66.7	13.5
EK.10.304	14	10	17.3	7.5	4.7	65.5	12.8
EK.10.339	12.5	10.2	17.5	6.8	4.1	65.8	13.5

EK 10.309

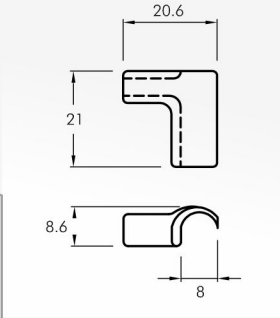

EK 10.311

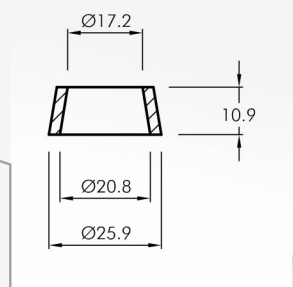

EK 10.312

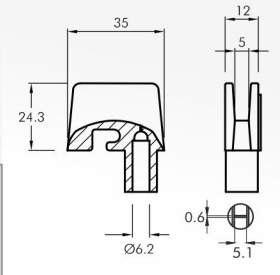

EK 10.313

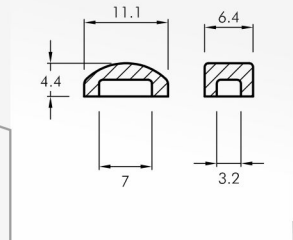

EK.10

EK 10.314

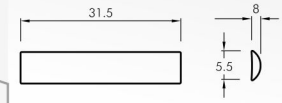
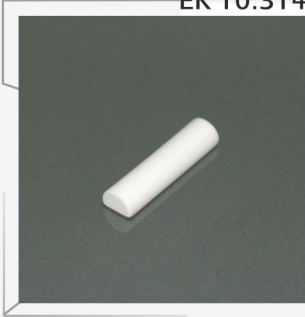

EK 10.315

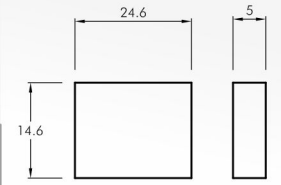
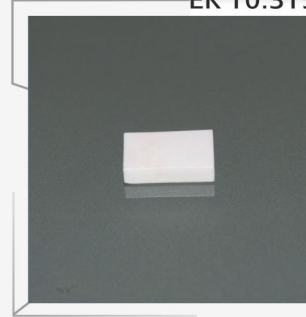

EK 10.316

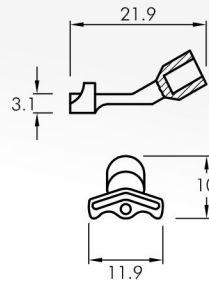
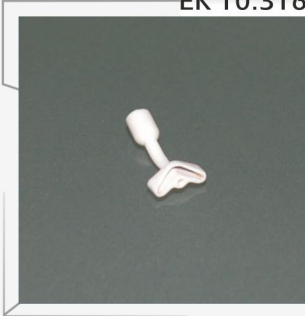

EK 10.317

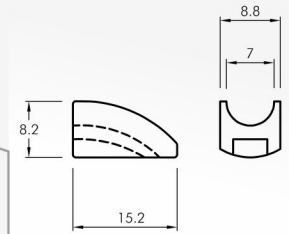

EK 10.318

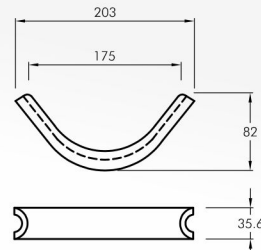

EK 10.319

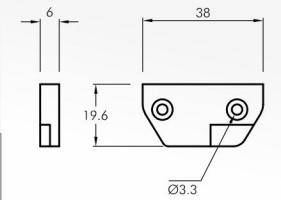

EK 10.322

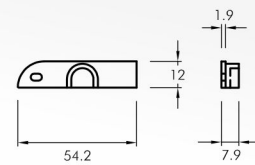
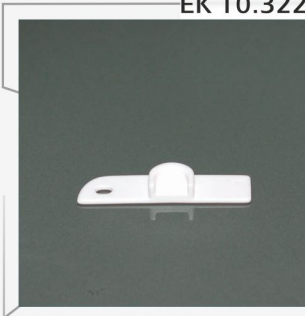

EK 10.323

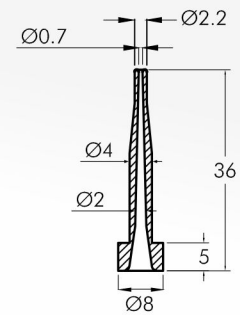
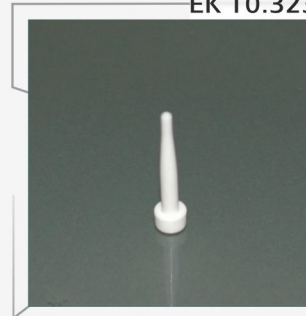

EK 10.324

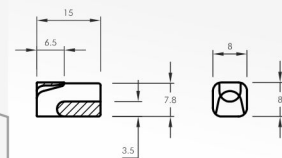
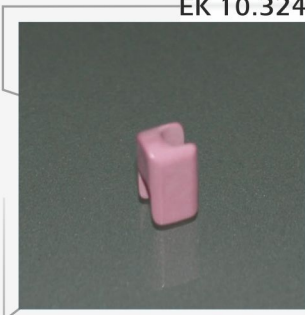

EK 10.325

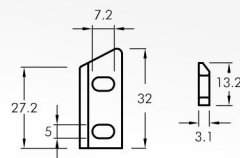
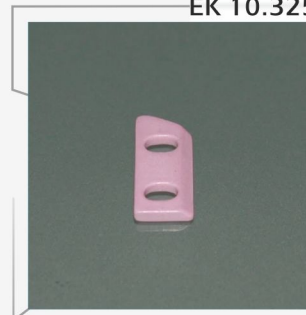



EK 10.326

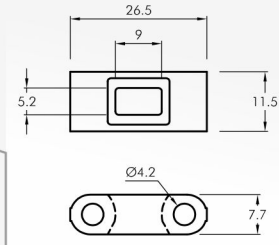

EK 10.327

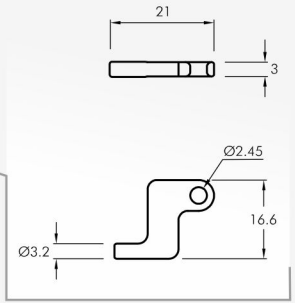
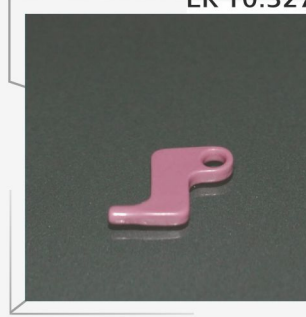

EK 10.329

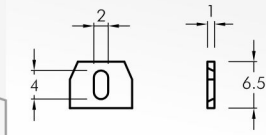
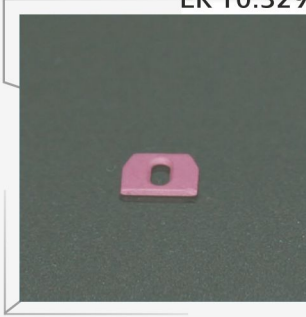

EK 10.330

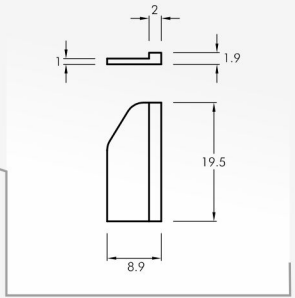
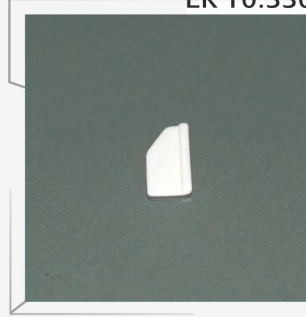

EK 10.331

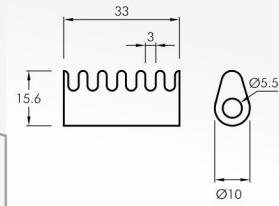
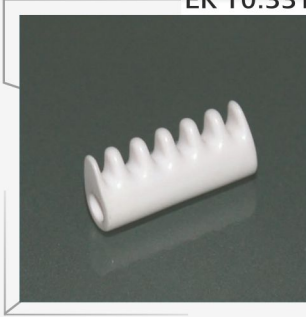

EK 10.332

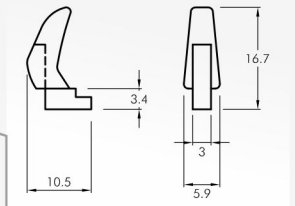

EK 10.333

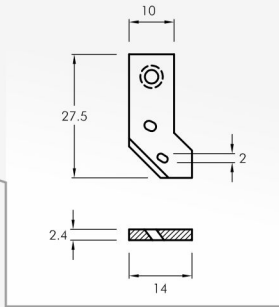
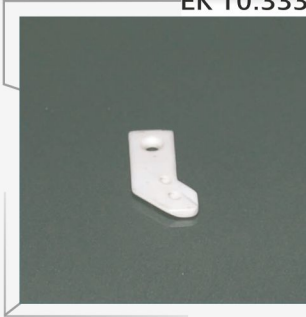

EK 10.334

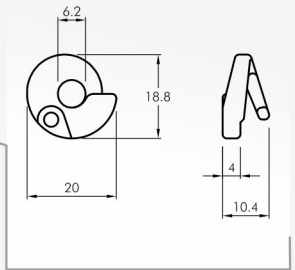
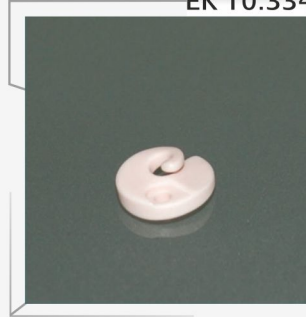

EK 10.335

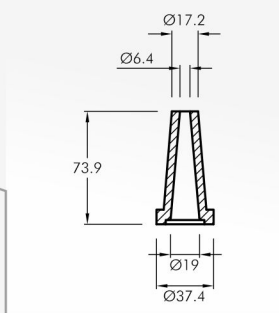

EK 10.336

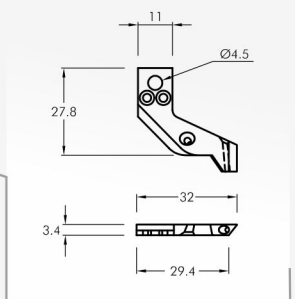

EK.10

EK 10.337

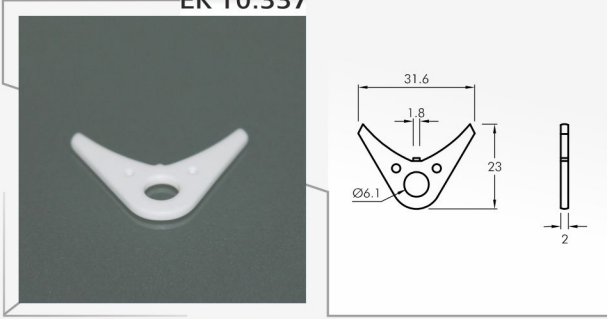

EK 10.338

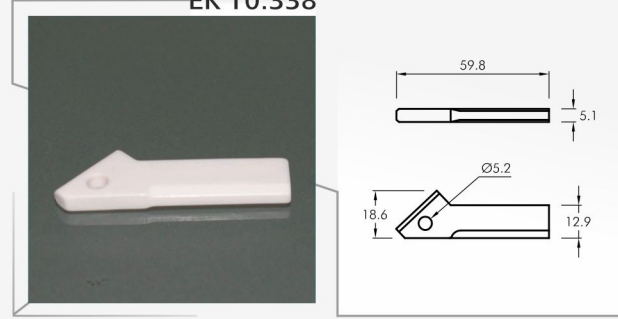

EK 10.340

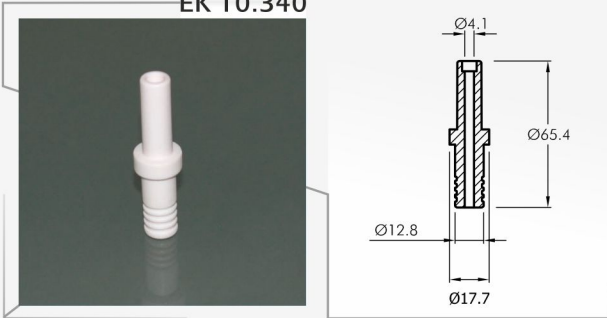

EK 10.341

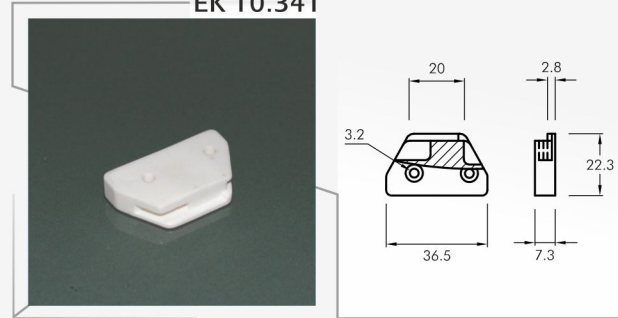

EK 10.342

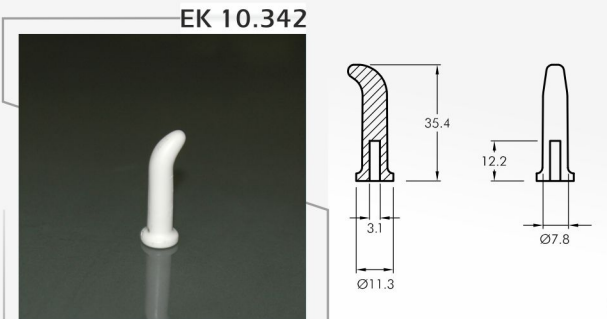

EK 10.343

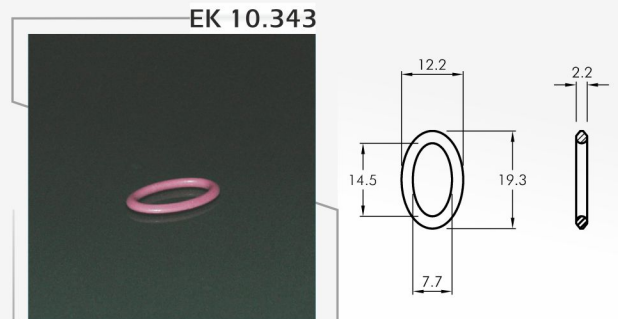

EK 10.344

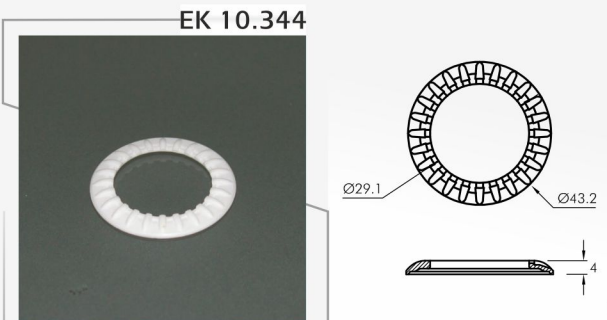

EK 10.345

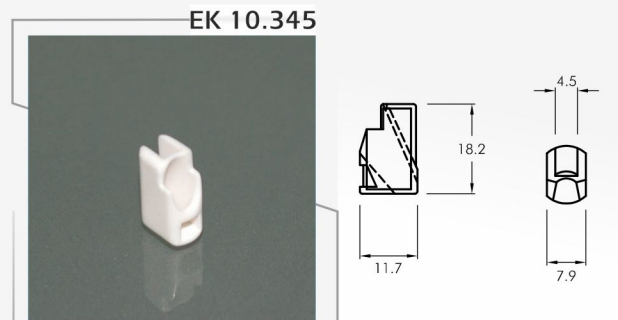

EK 10.346

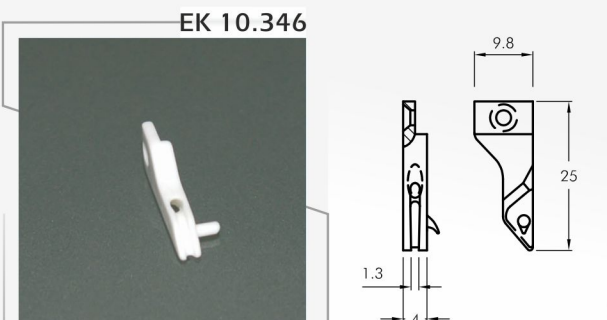

EK 10.347

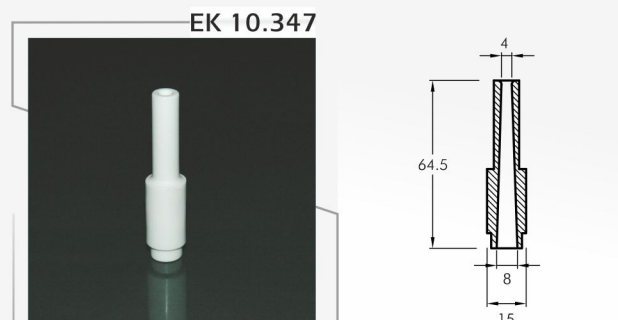

EK 10.348

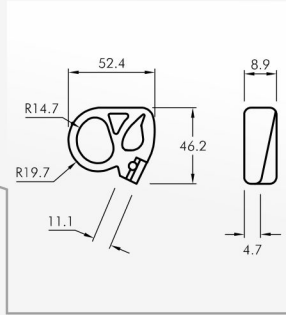
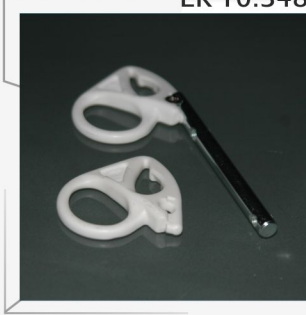

EK 10.350

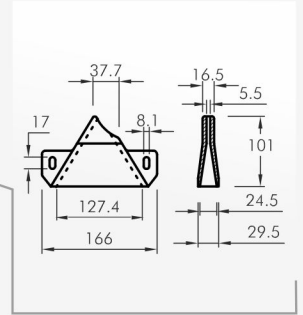

EK 10.351

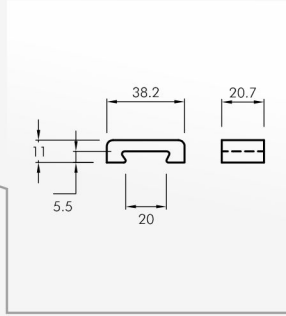

EK 10.352

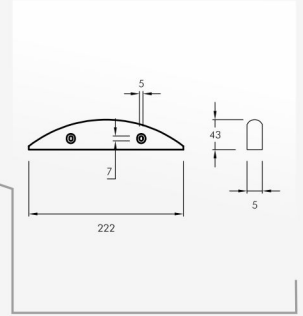

EK 10.353

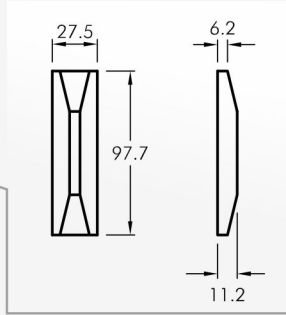
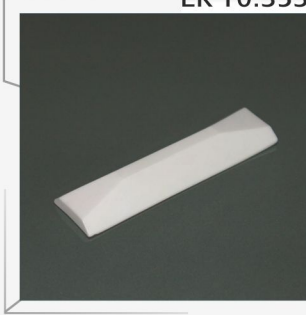

EK 10.354

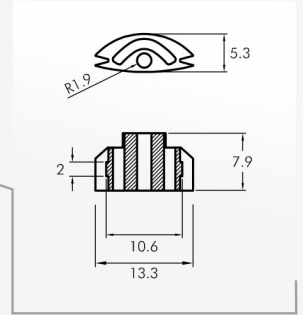

EK 10.355

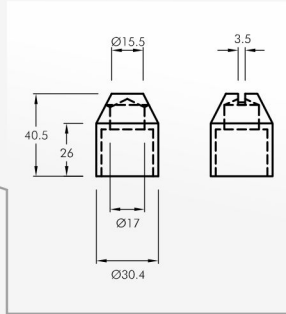

EK 10.356

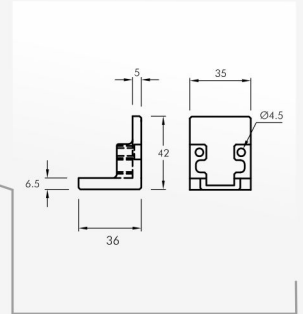
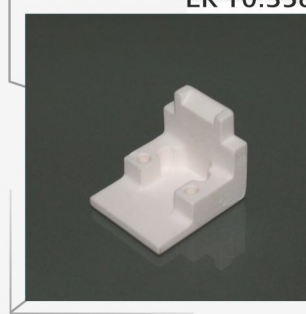

EK 10.357

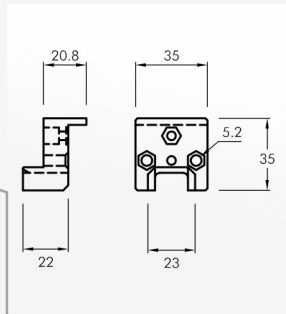

EK 10.358

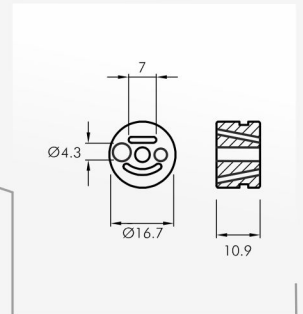

EK.10

EK 10.359

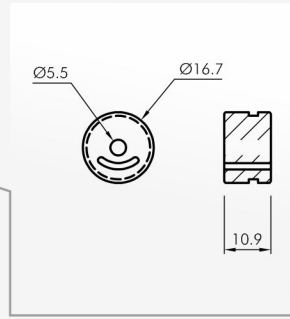
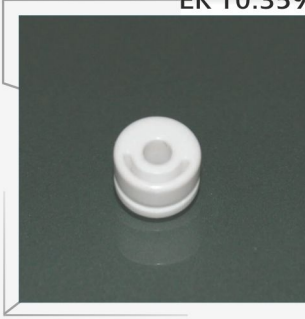

EK 10.361

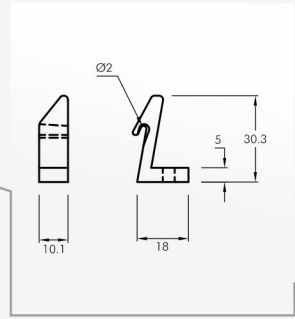

EK 10.362

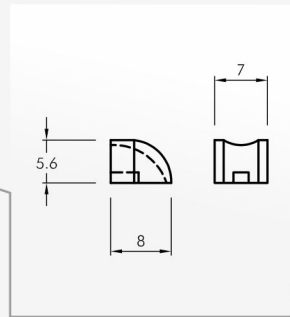
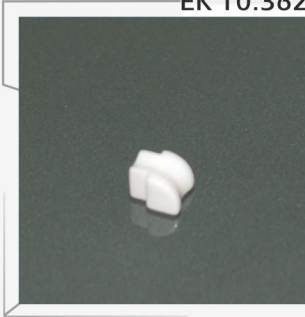

EK 10.363

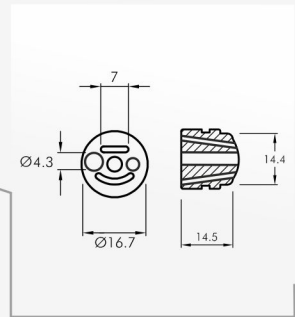

EK 10.364

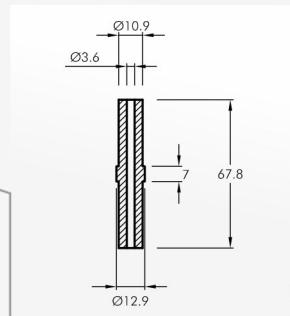
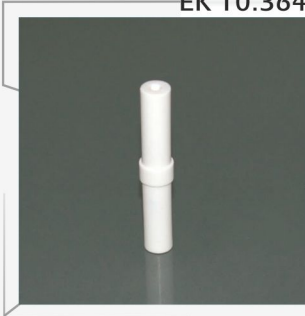

EK 10.365

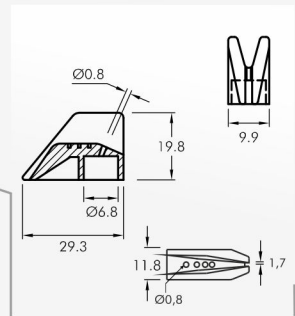
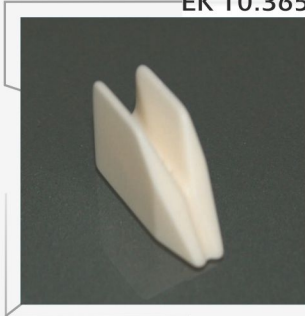

EK 10.366

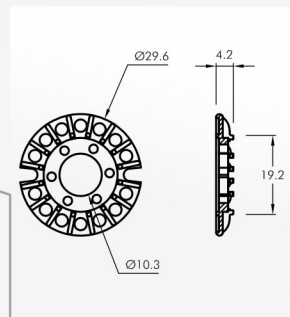
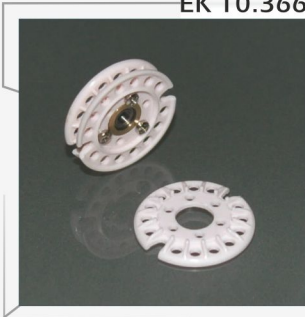

EK 10.367

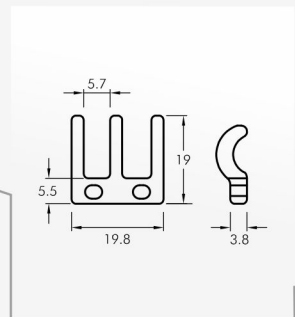
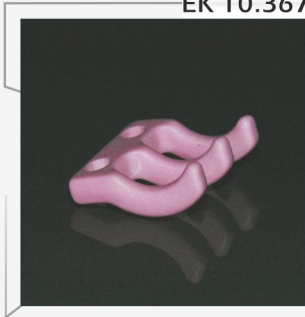

EK 10.368

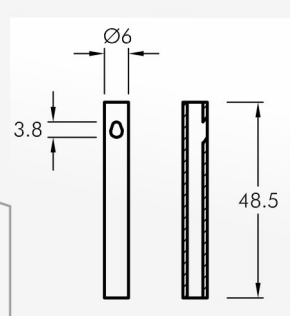

EK 10.369

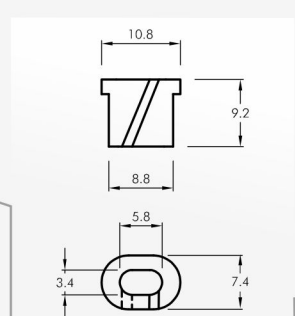
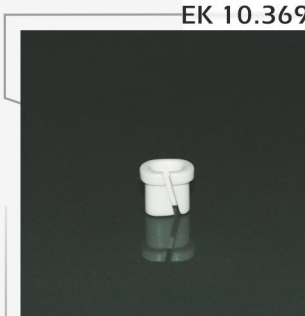

EK 10.370

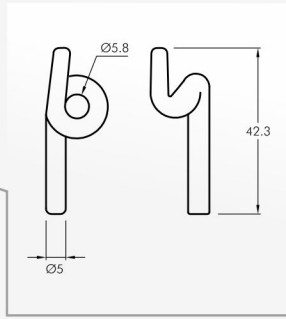
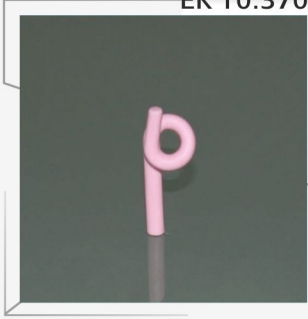

EK 10.371

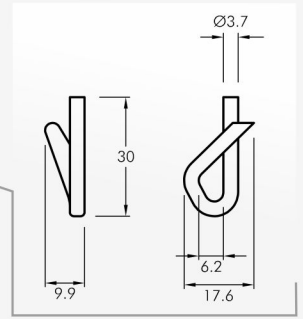
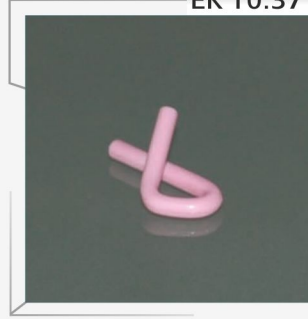

EK 10.372

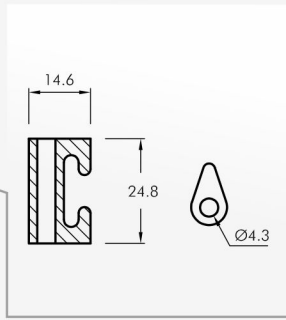
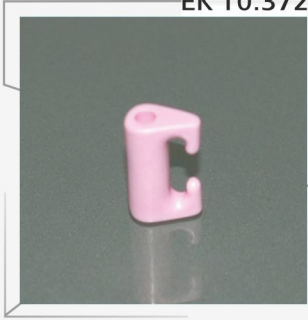

EK 10.373

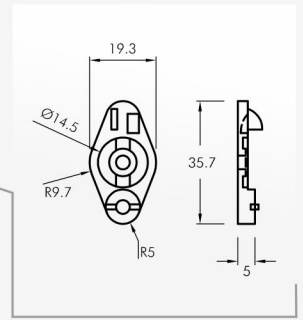
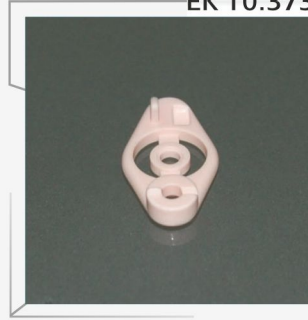

EK 10.374

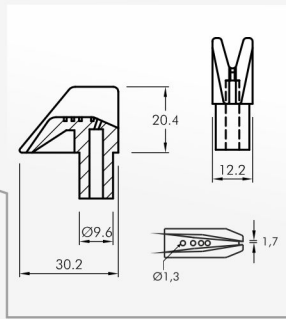

EK 10.375

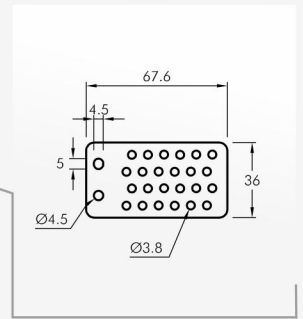
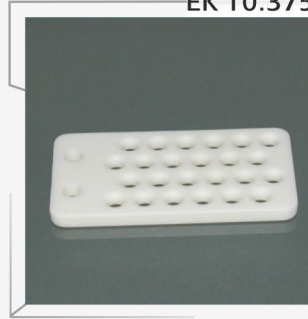

EK 10.376

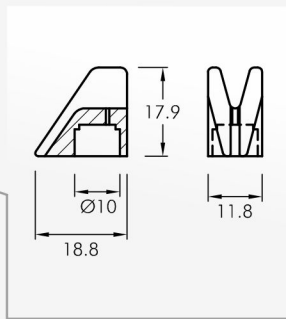

EK 10.377

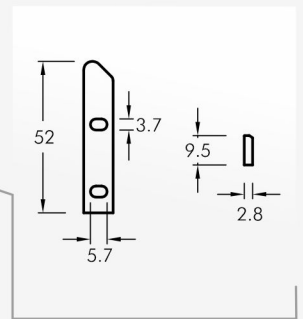

EK 10.378

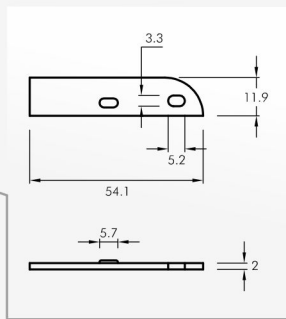
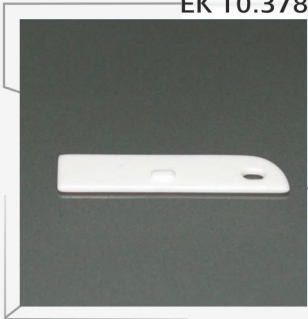

EK 10.380

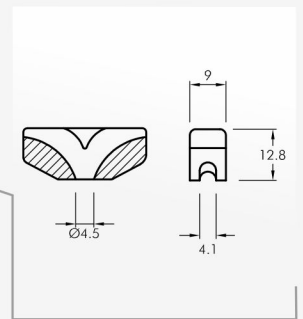

EK.10

EK 10.381

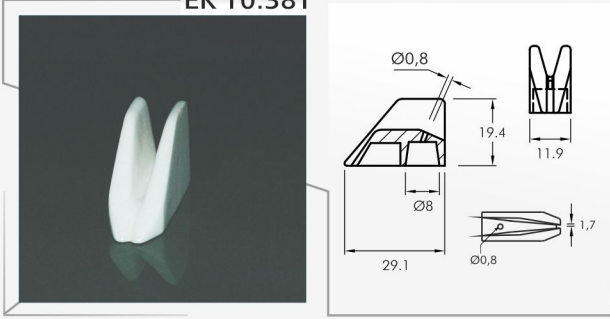

EK 10.382

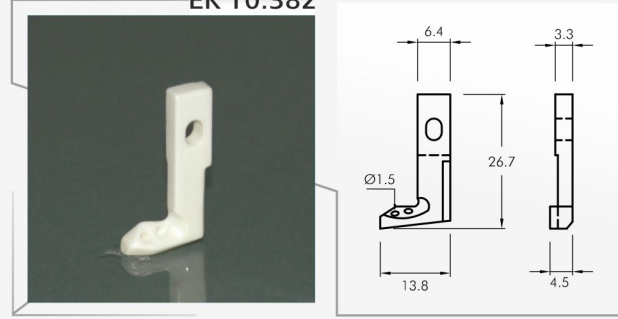

EK 10.383

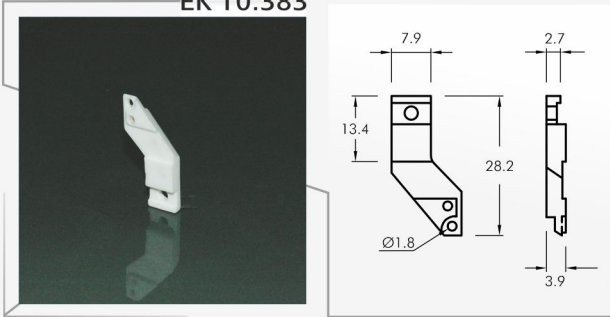

EK 10.384

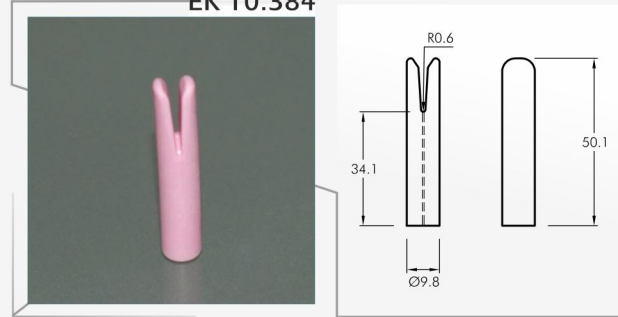

EK 10.385

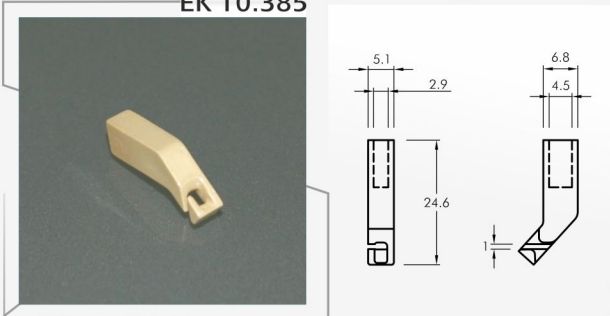

EK 10.386

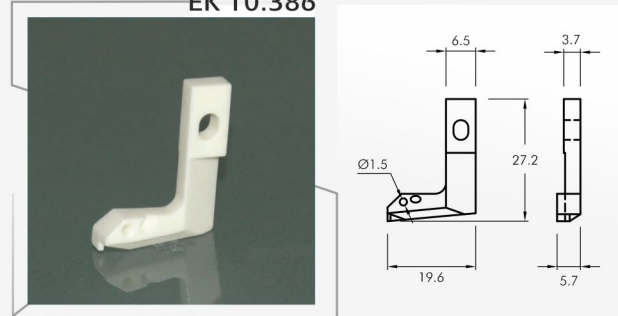

EK 10.388

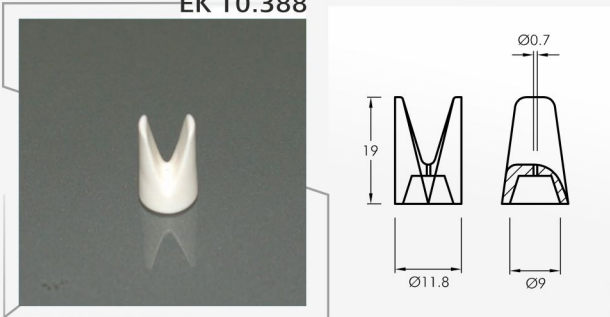

EK 10.389

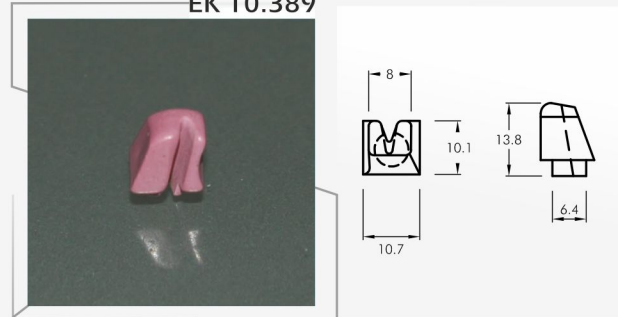

EK 10.390

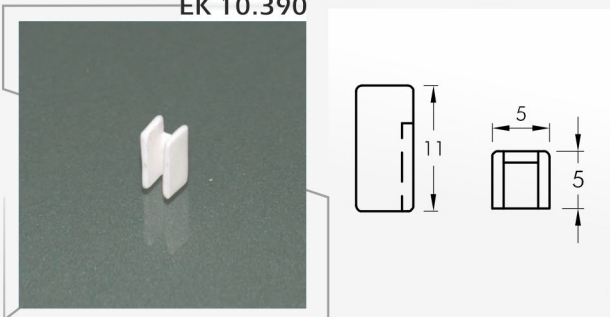

EK 10.391

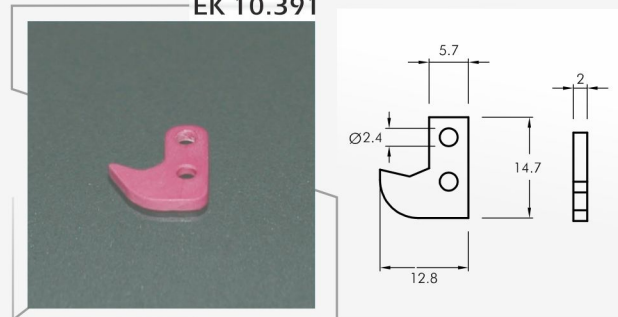

EK 10.395

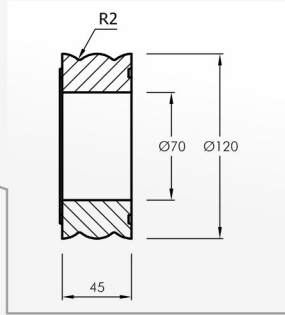

EK 10.396

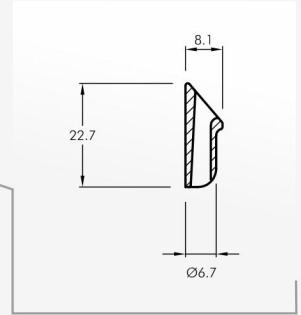

EK 10.398

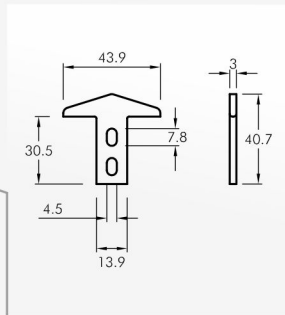
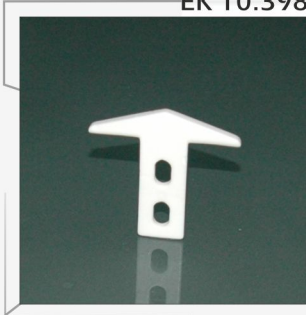

EK 10.400

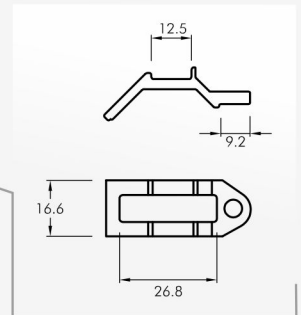

EK 10.402

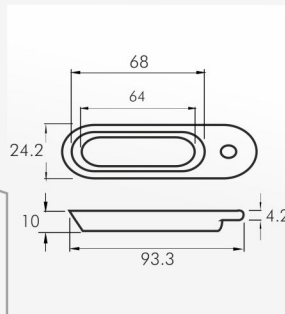
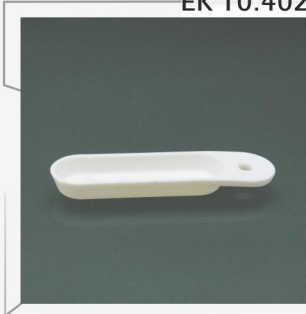

EK 10.405

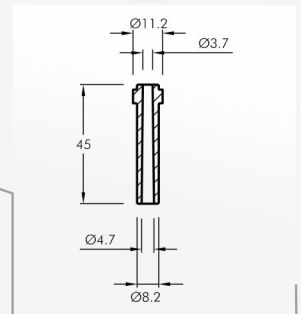
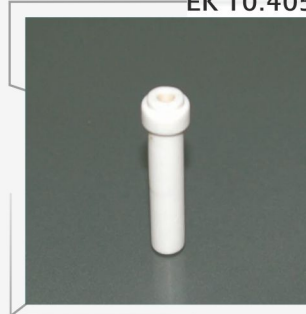

EK 10.406

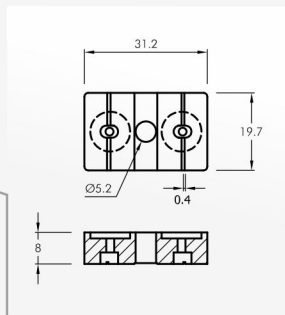
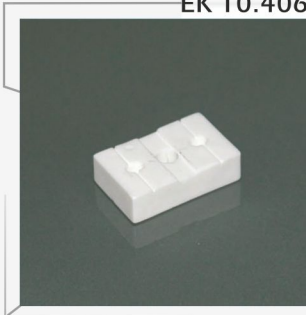

EK 10.407

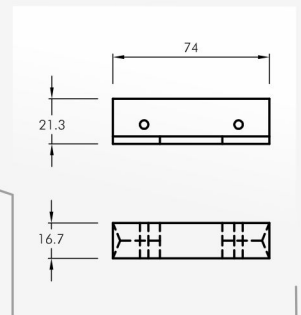

EK 10.408

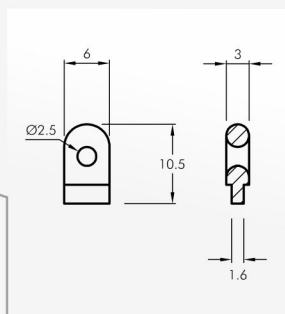

EK 10.409

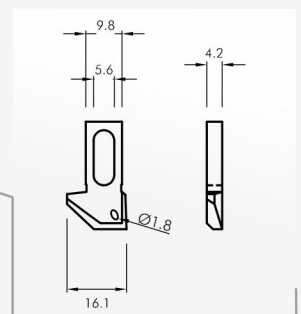

EK.10

EK 10.410

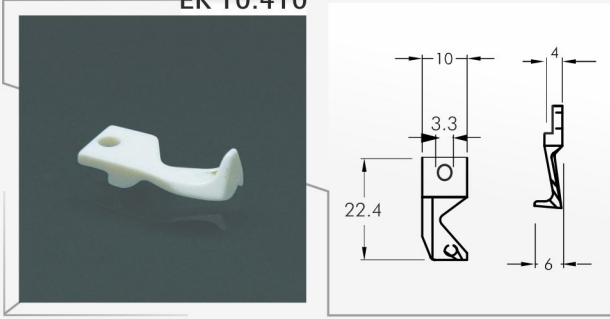

EK 10.411

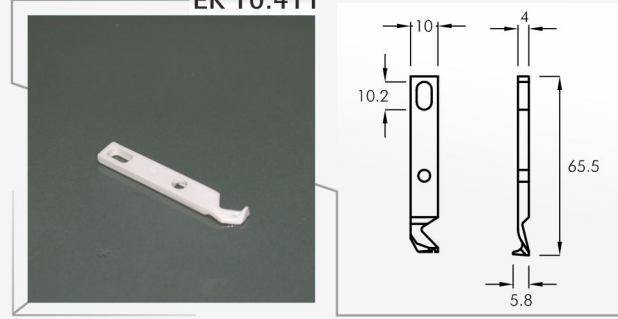

EK 10.412

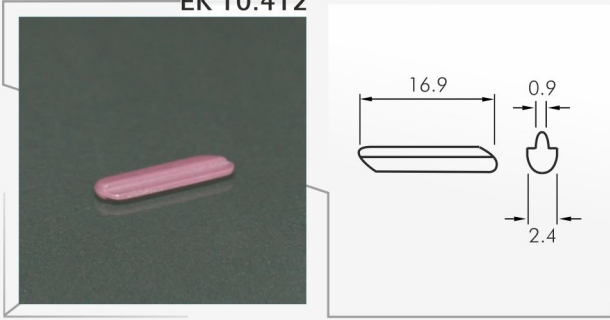

EK 10.413

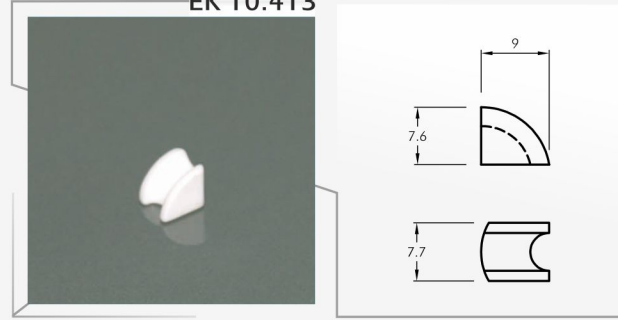

EK 10.414

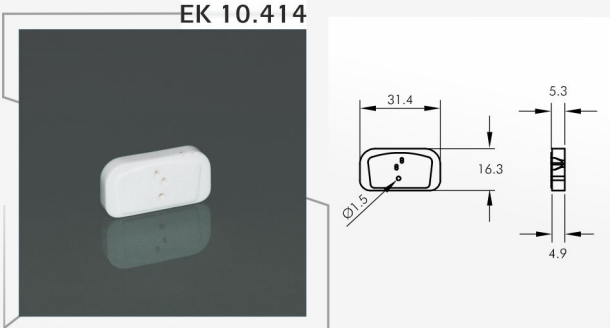

EK 10.415

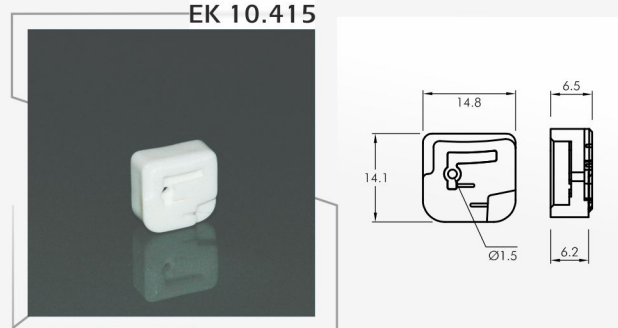

EK 10.416

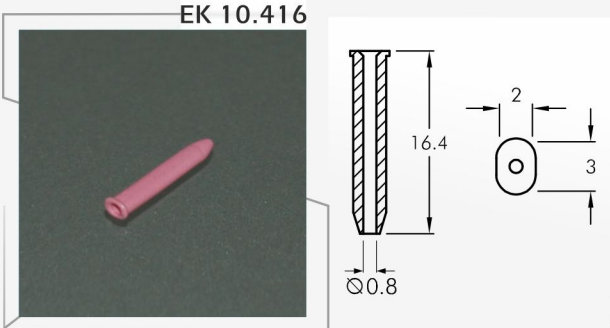

EK 10.417

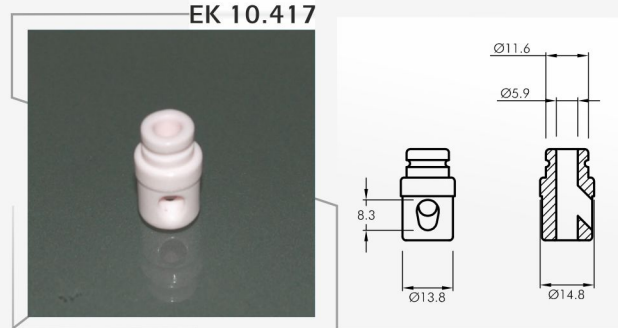

EK 10.418

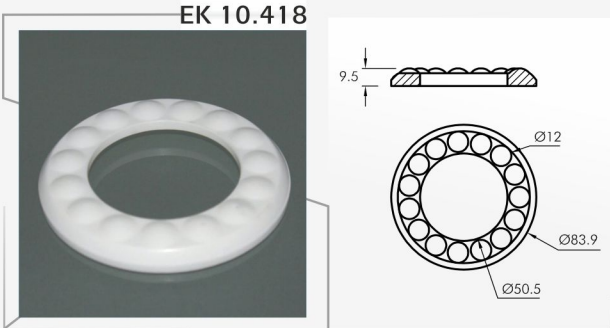

EK 10.419

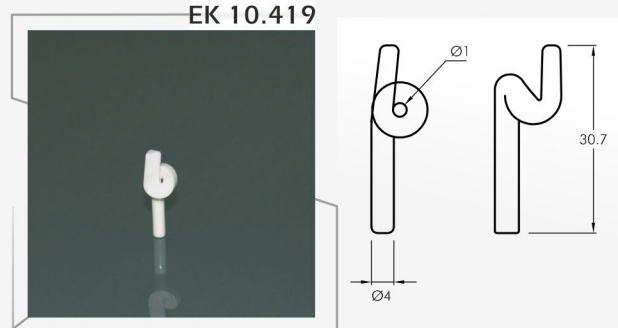

EK 10.420

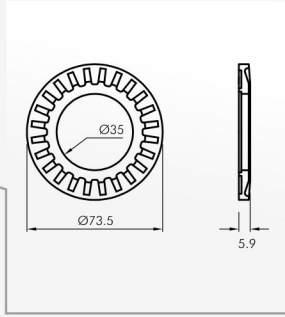
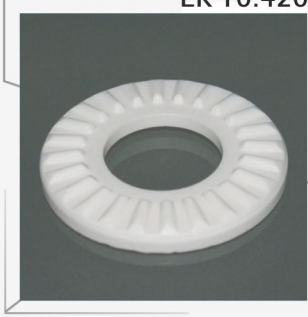

EK 10.421

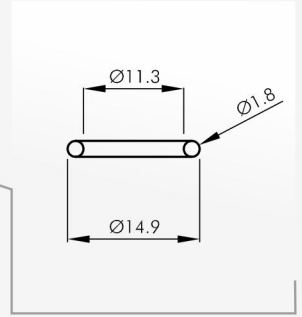
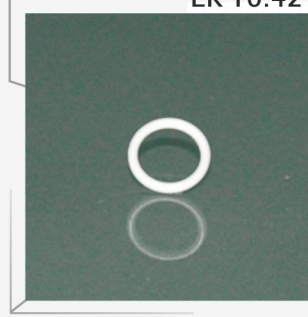

EK 10.422

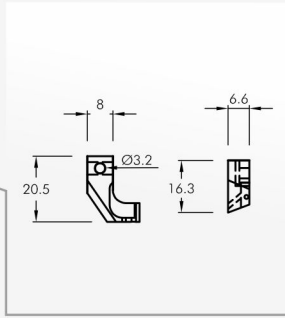
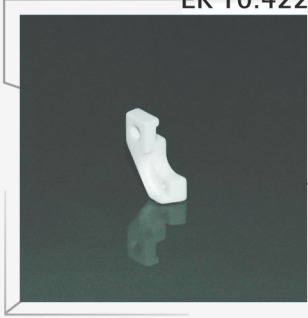

EK 10.423

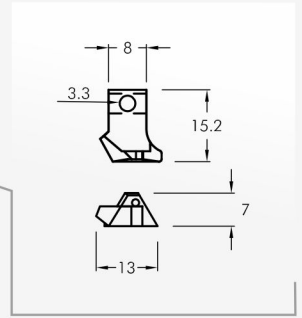
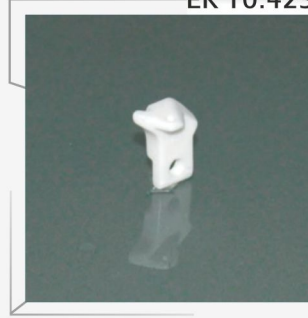

EK 10.424

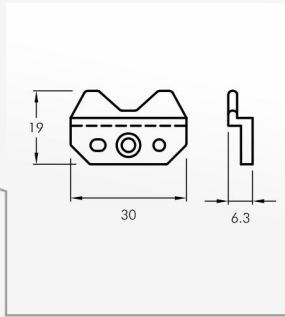
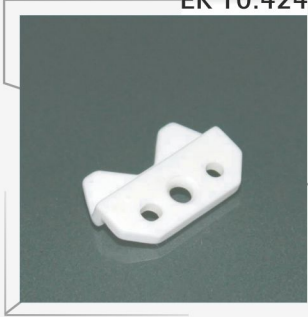

EK 10.425

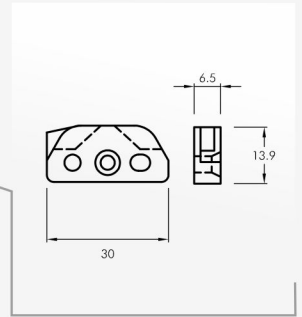

EK 10.426

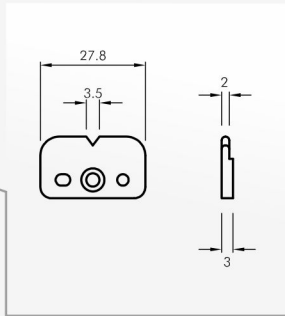
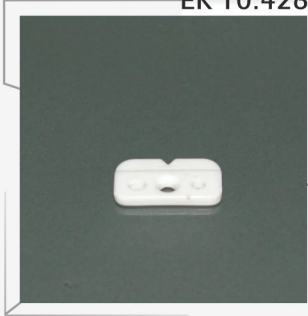

EK 10.427

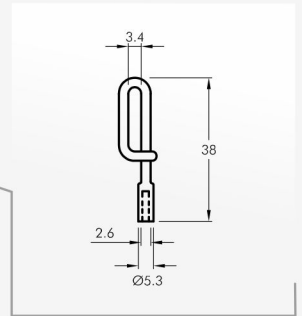

EK 10.428

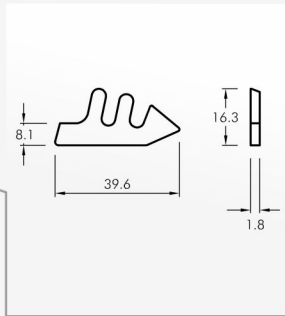

EK 10.429

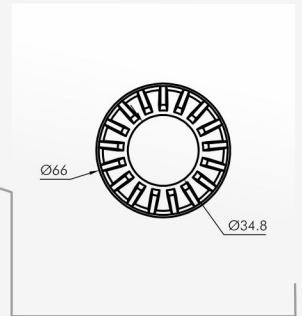

EK 10.431

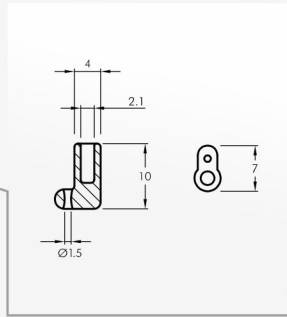
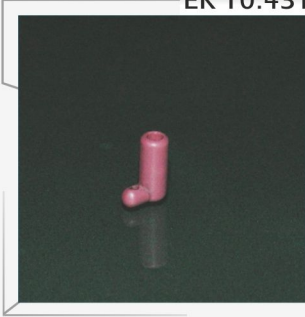

EK 10.432

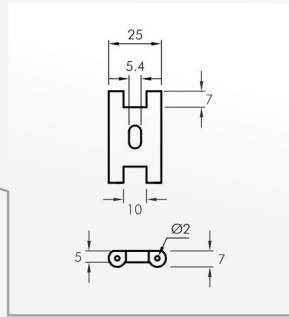
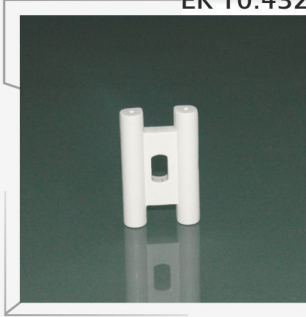

EK 10.433

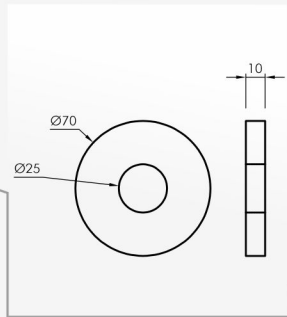
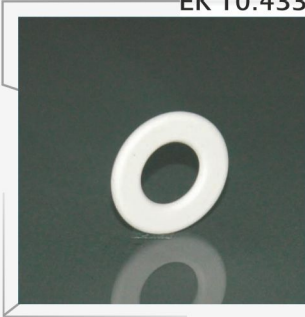

EK 10.434

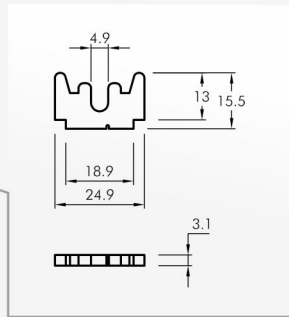
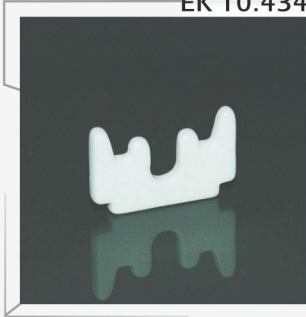

EK 10.435

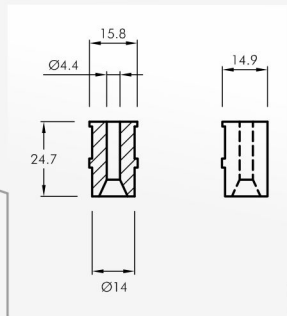

EK 10.436

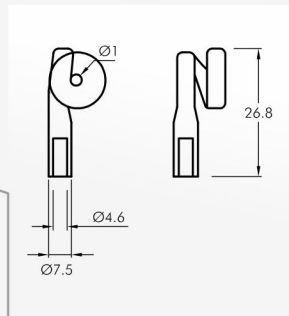

EK 10.437

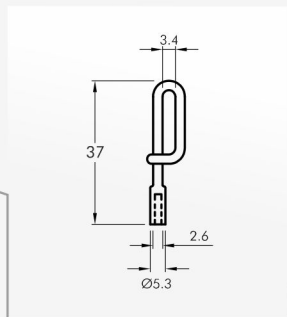
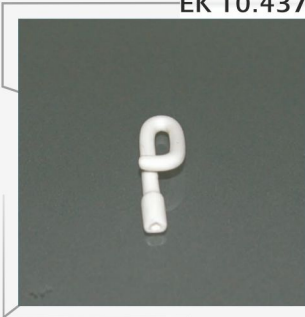

EK 10.439

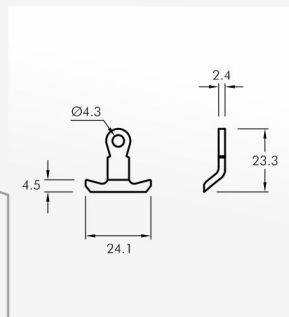

EK 10.440

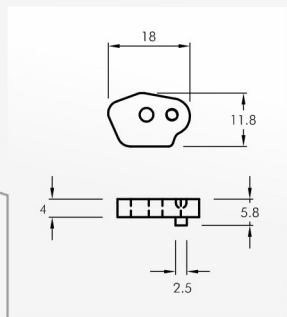
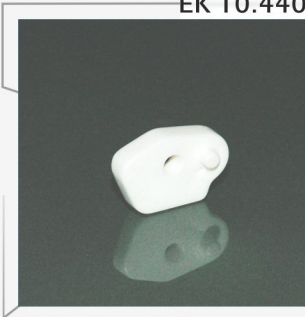

EK 10.441

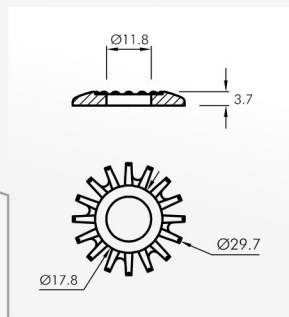
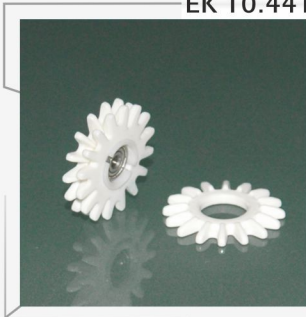

EK 10.442

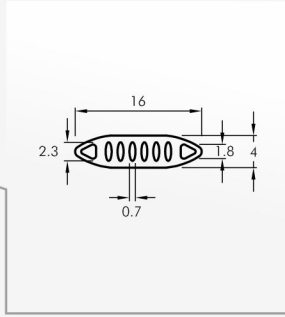
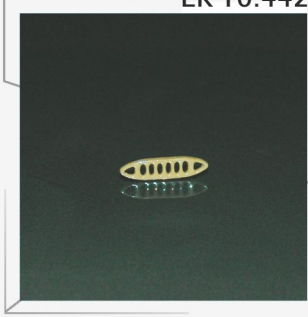

EK 10.443

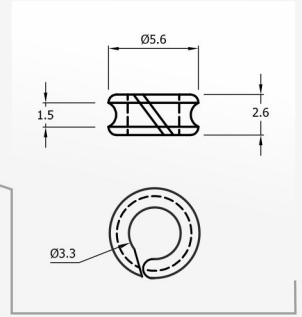
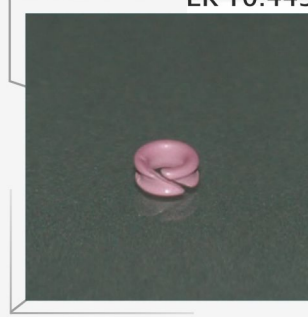

EK 10.444

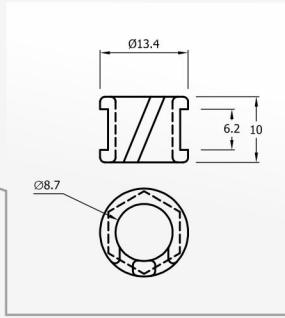
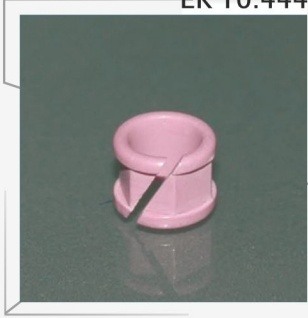

EK 10.445

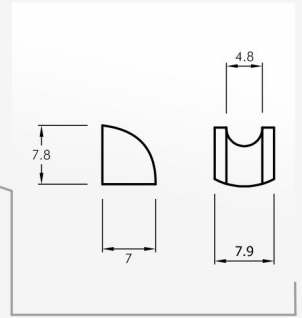
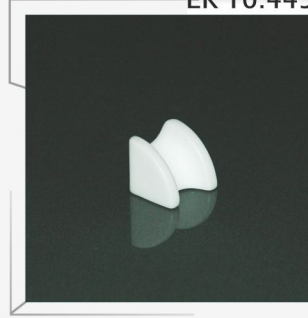

EK 10.446

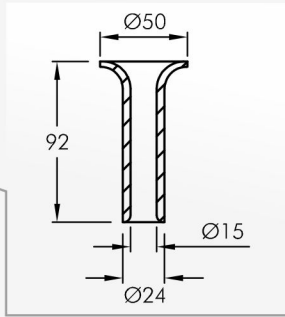

EK 10.447

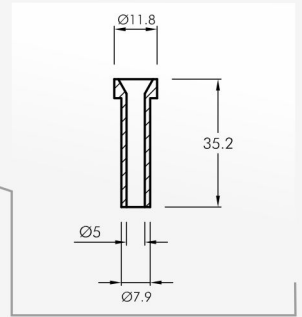
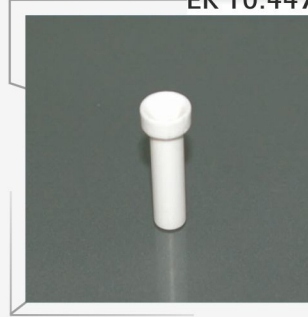

EK 10.448

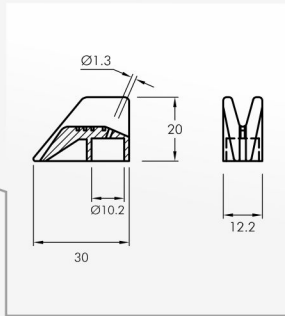
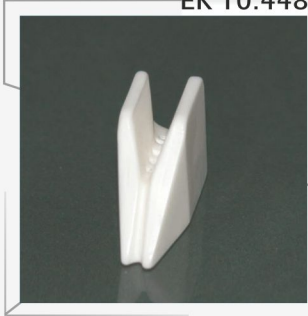

EK 10.449

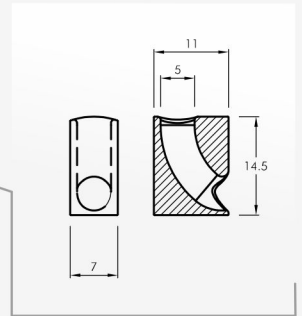
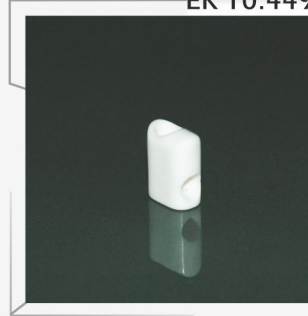

EK 10.450

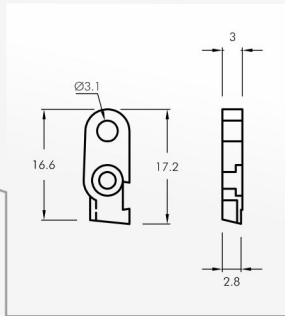

EK 10.451

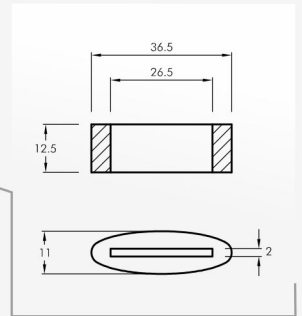

EK.10

EK 10.452

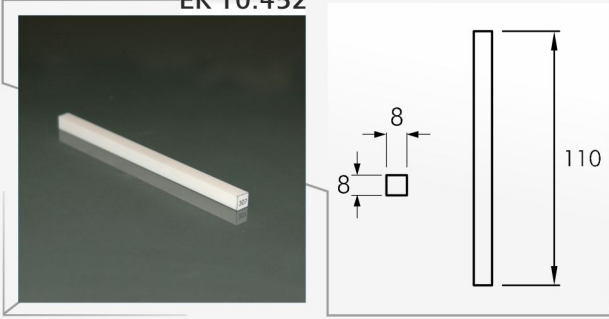

EK 10.454

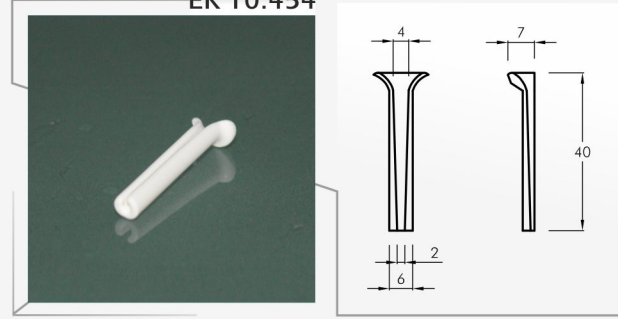

EK 10.455

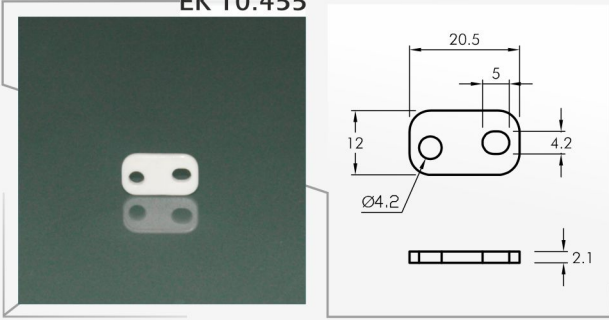

EK 10.456

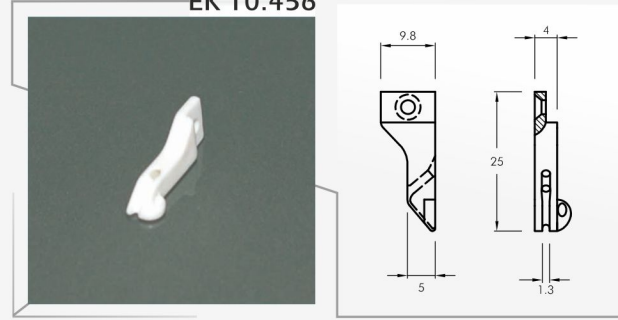

EK 10.457

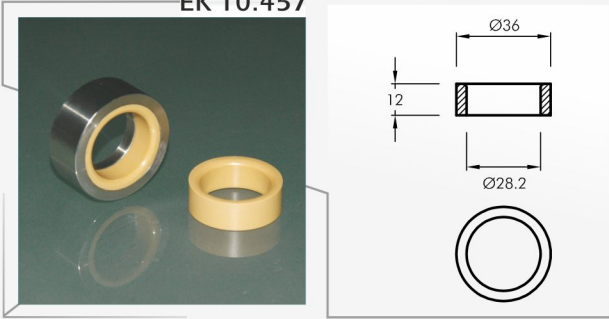

EK 10.458



EK 10.459

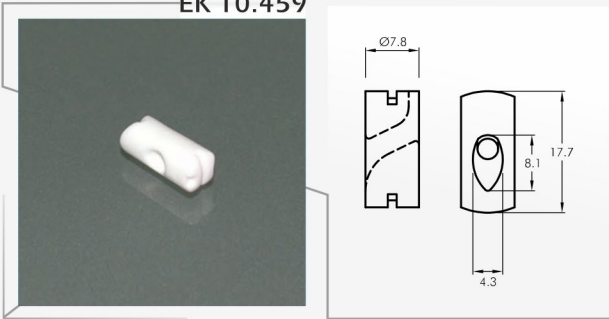

EK 10.460

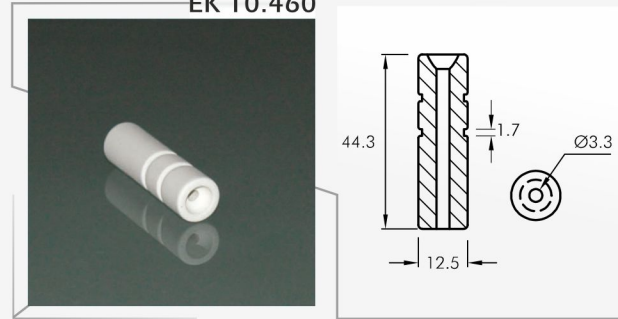

EK 10.461

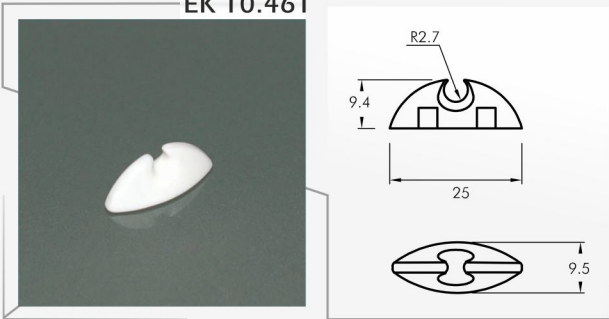

EK 10.462

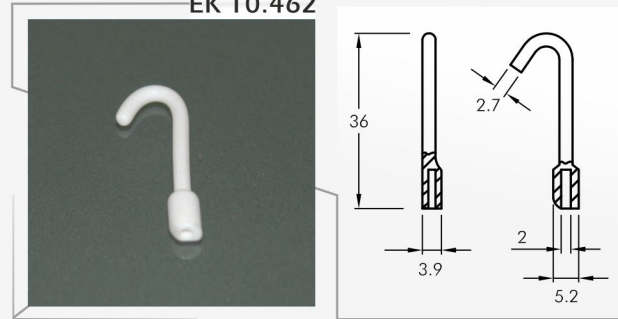

EK 10.463

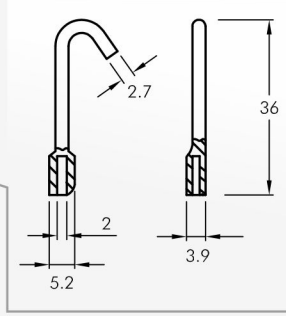
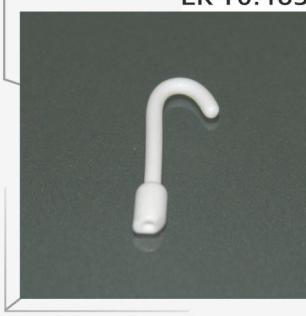

EK 10.464

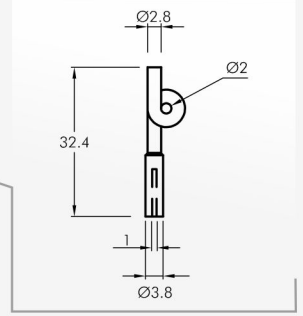
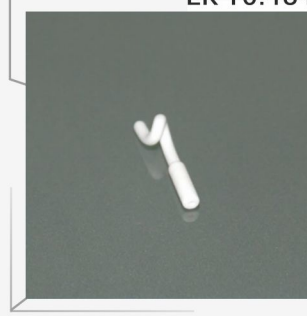

EK 10.465

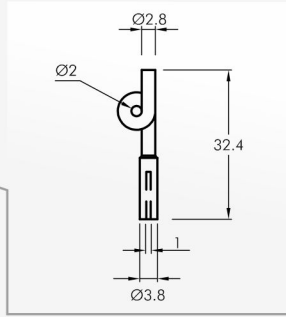
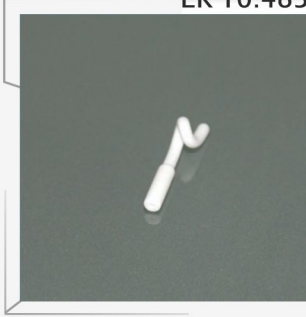

EK 10.466

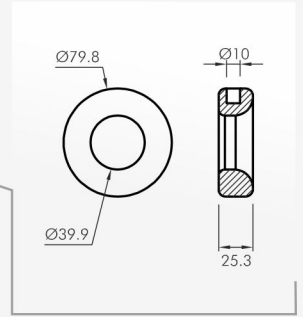

EK 10.468

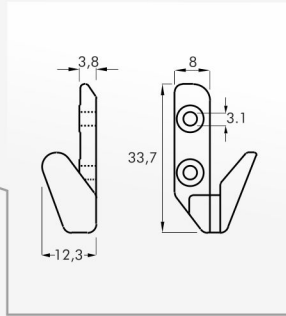
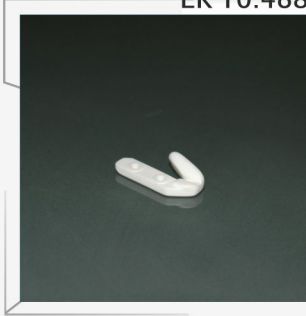

EK 10.469

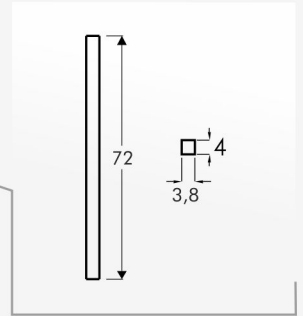
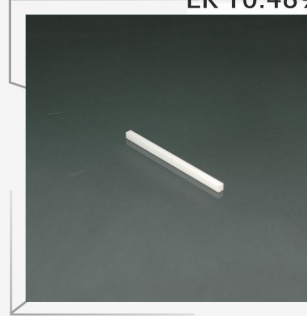

EK 10.470

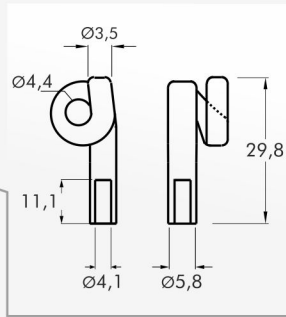
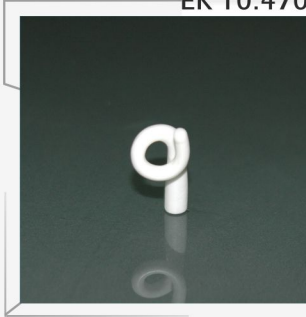

EK 10.471

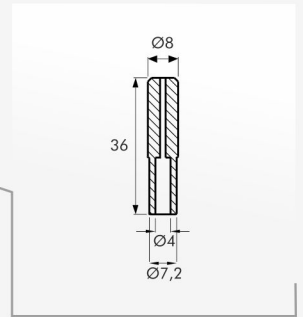
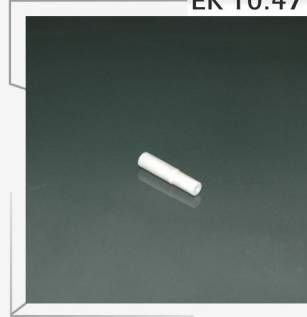

EK 10.472

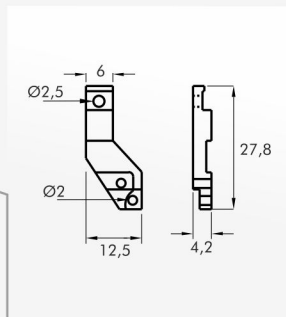
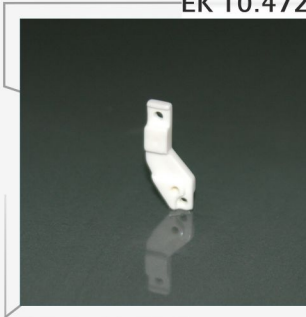

EK 10.473

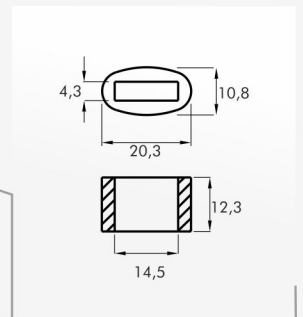

EK.10

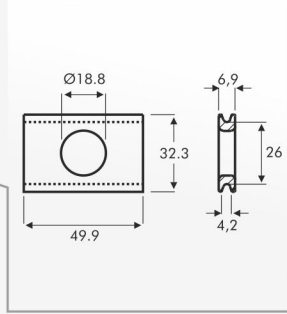
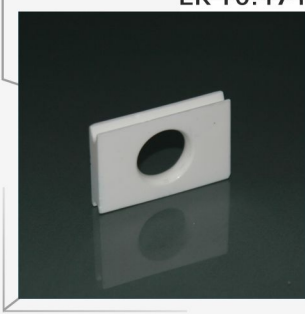
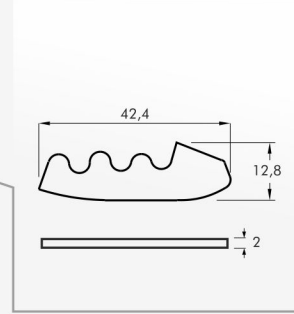
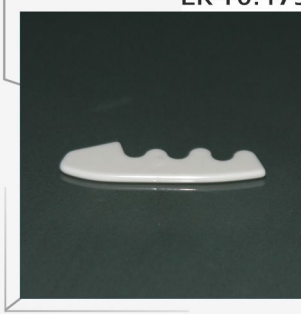
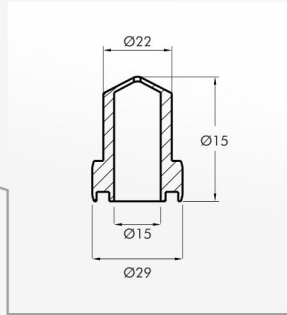
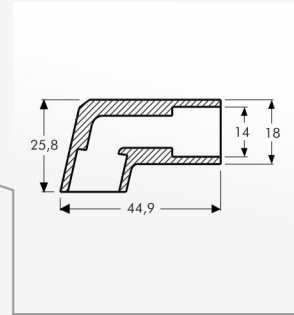
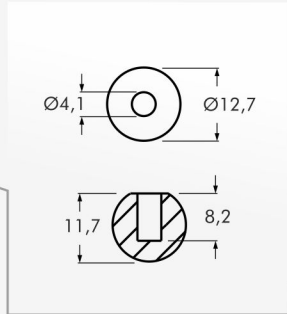
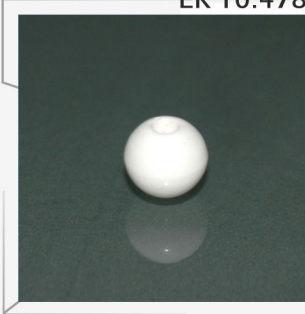
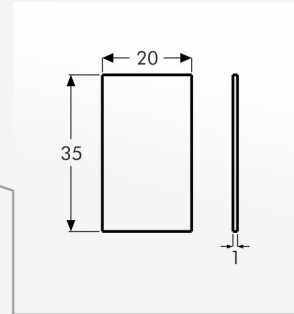
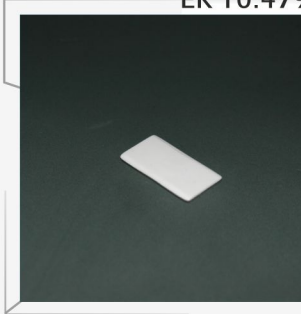
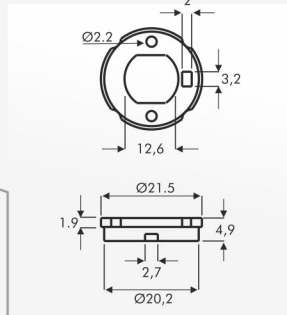
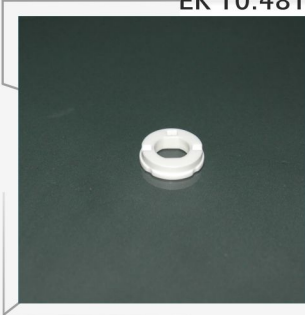
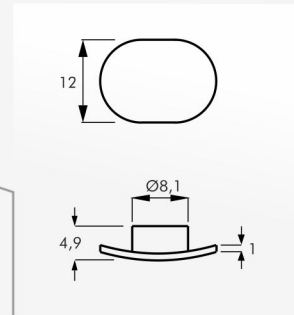
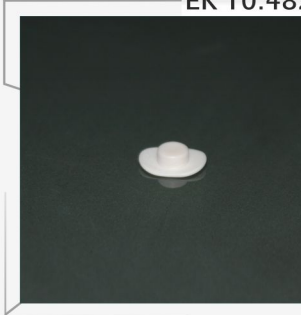
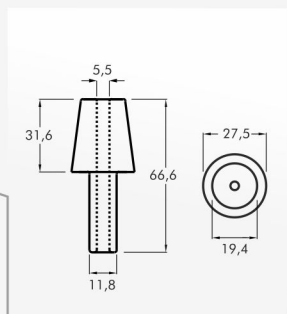
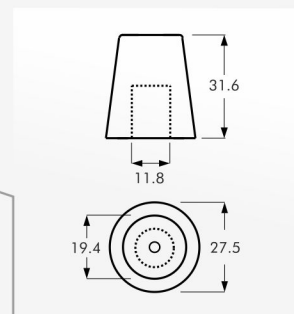
EK 10.474

EK 10.475

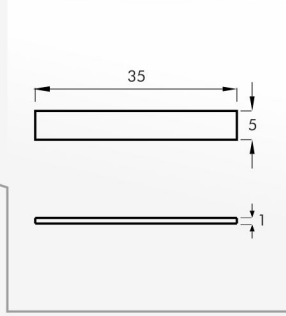
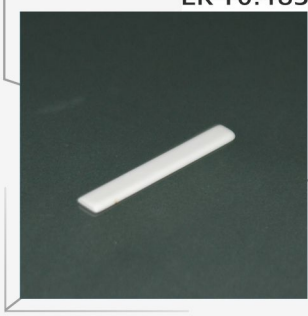
EK 10.476

EK 10.477

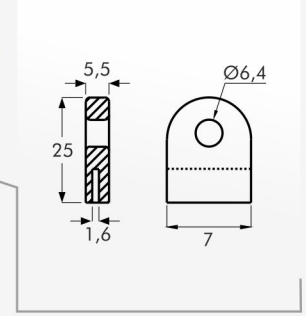
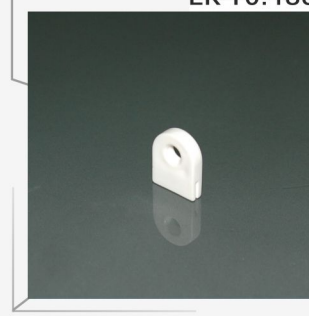
EK 10.478

EK 10.479

EK 10.481

EK 10.482

EK 10.484

EK 10.485

EK 10.483



EK 10.486



EK 10.487

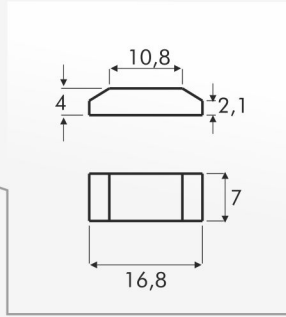
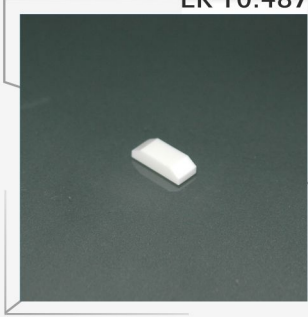

EK 10.490

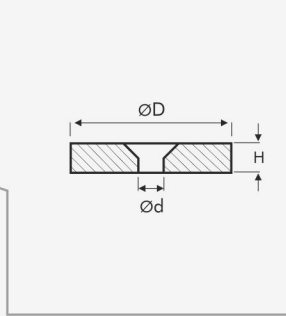
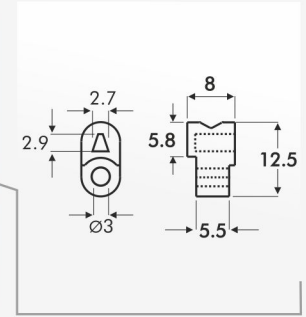
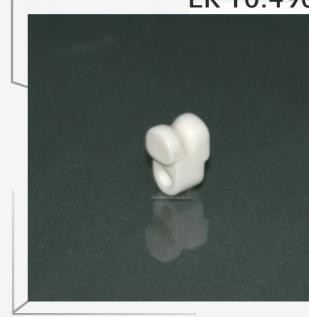

KOD NO	D	d	H
EK-10.488	15	1,2	3,3
EK-10.489	15	1,5	3,3
EK-10.524	15	1,8	3,1
EK-10.525	15	2	3,1
EK-10.528	15	0,8	3,4

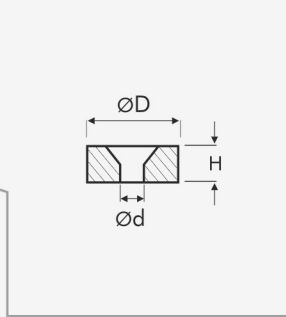

KOD NO	D	d	H
EK-10.493	7,5	1,2	3,1
EK-10.494	7,5	1,5	3,1
EK-10.495	7,5	2	3
EK-10.496	7,5	2,5	3,1
EK-10.583	7,5	2,1	3,2
EK-10.554	7,5	3	3

EK 10.491

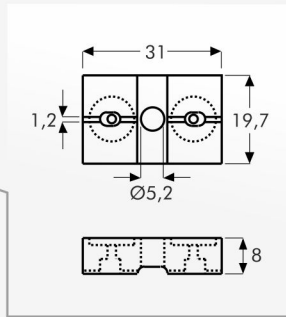
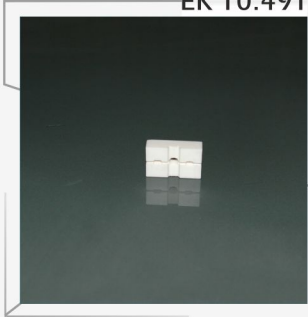

EK 10.492

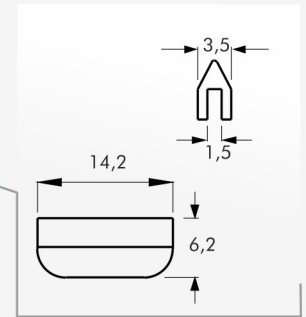

EK 10.497

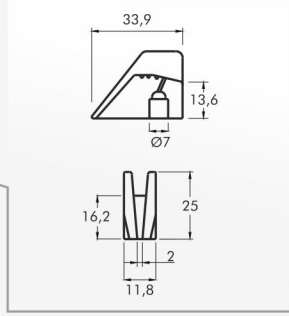
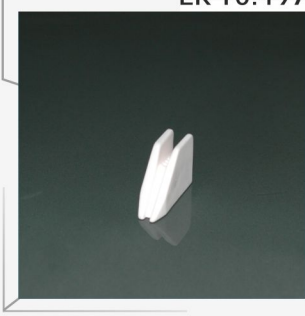

EK 10.498

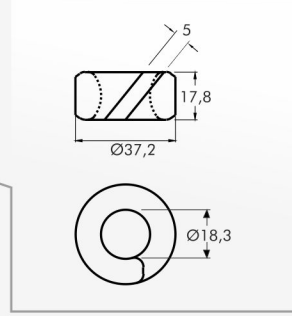
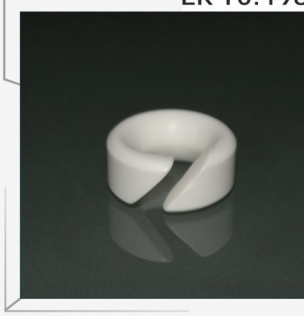

EK 10.499

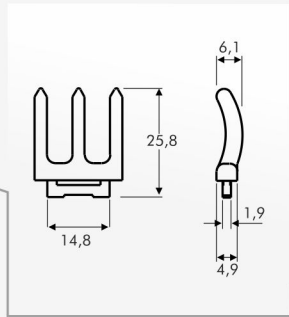
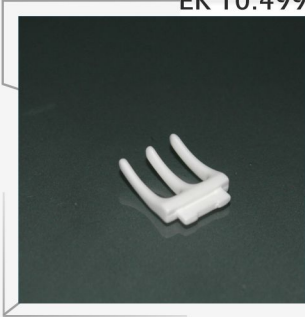

EK 10.502

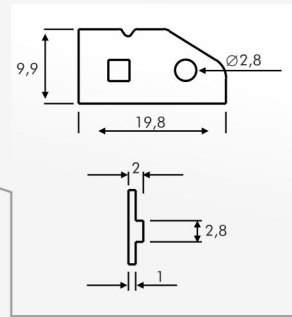
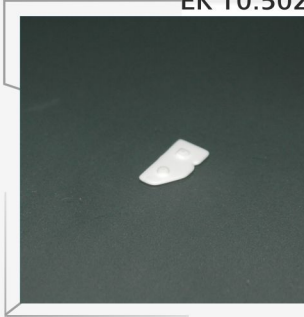

EK 10.503

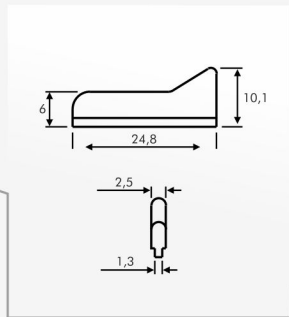
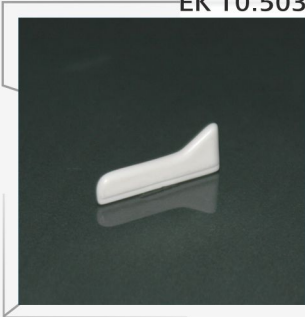

EK 10.504

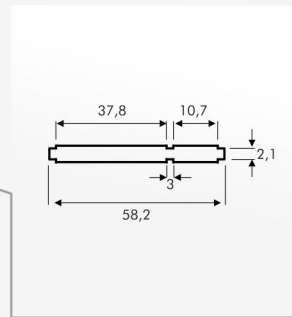
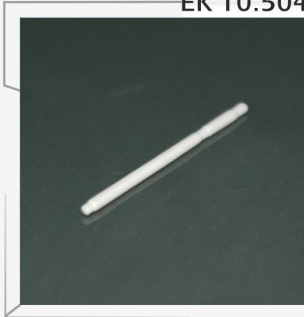

EK 10.506

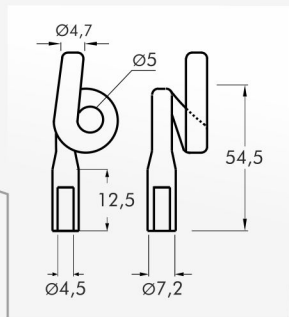
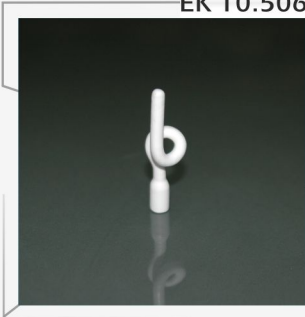

EK 10.507

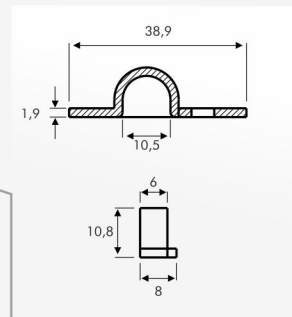
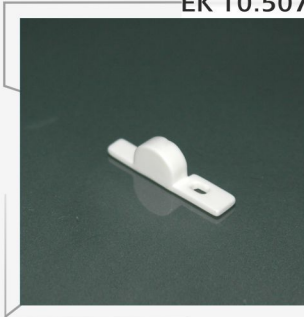

EK 10.508

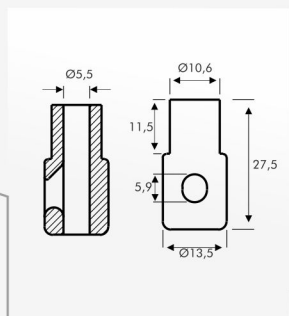
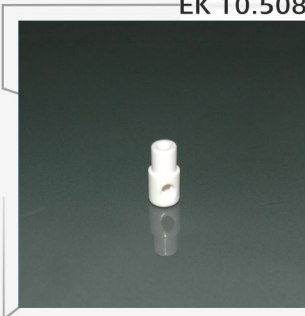

EK 10.509

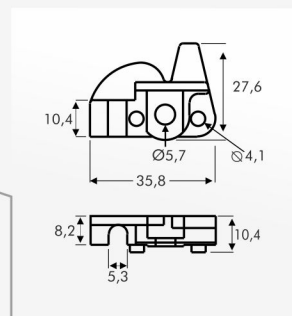

EK 10.510

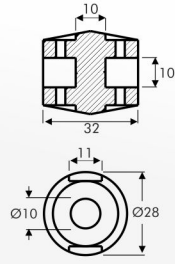

EK 10.512

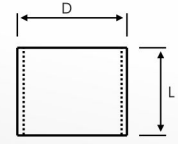
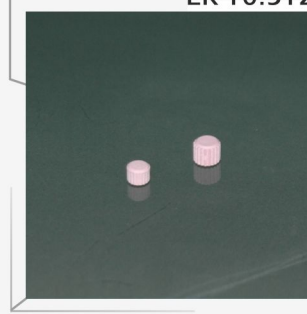

KOD NO	D	L
EK 10.512	5,5	4,4
EK 10.557	6,7	5,6

EK 10.514

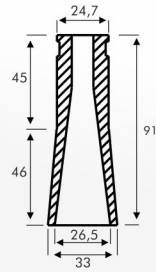

EK 10.515

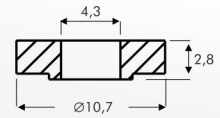
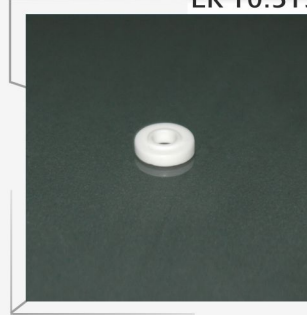

EK 10.516

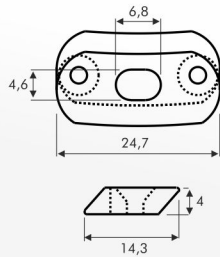
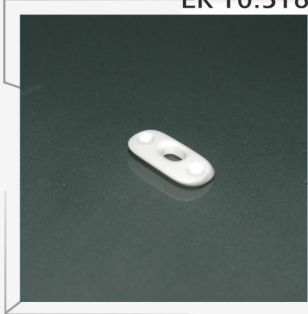

EK 10.517

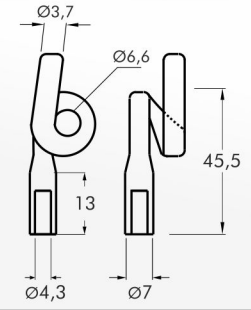
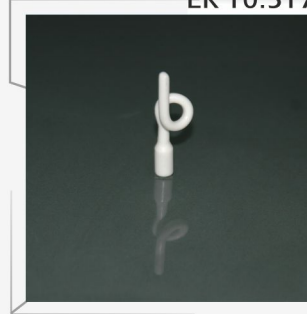

EK 10.518

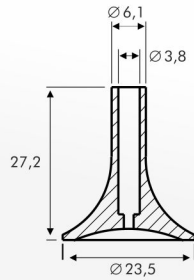

EK 10.520

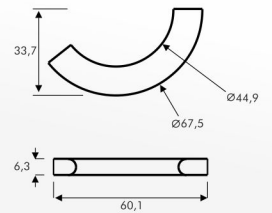

EK 10.521

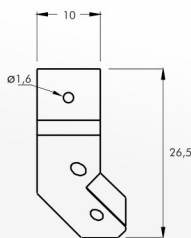

EK 10.522

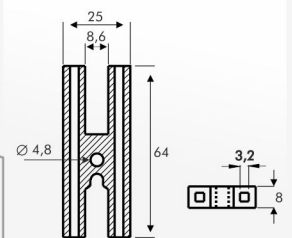
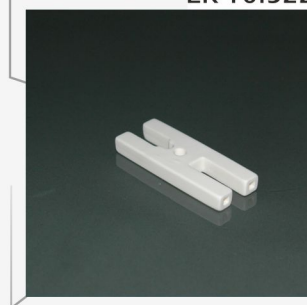

EK 10.527

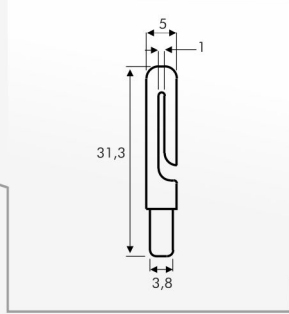
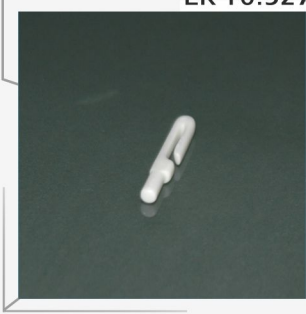

EK 10.529

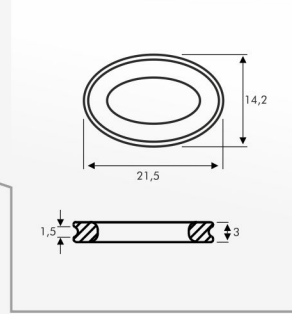
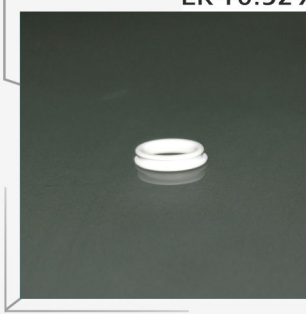

EK 10.530

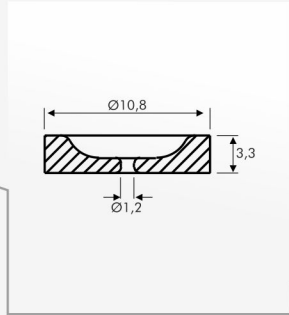
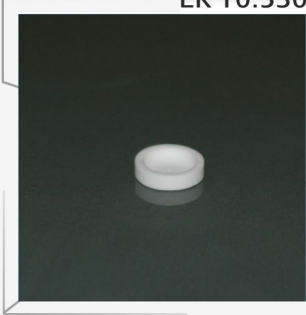

EK 10.531

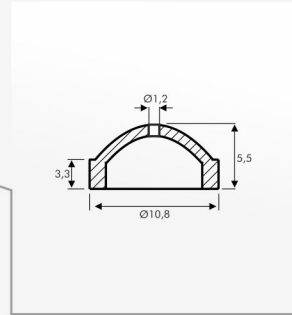
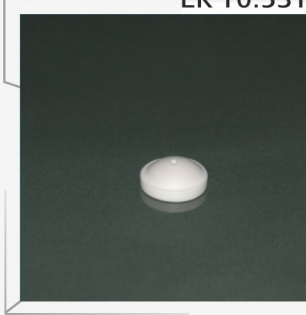

EK 10.533

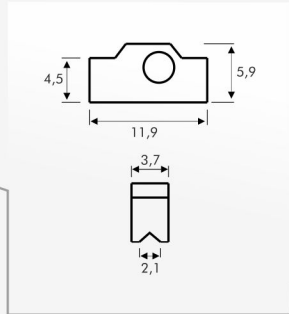
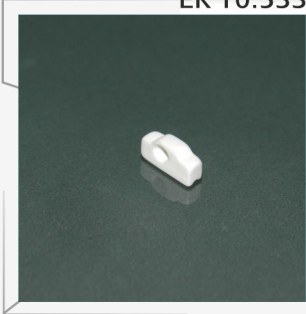

EK 10.535

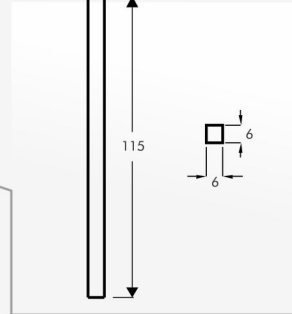

EK 10.536

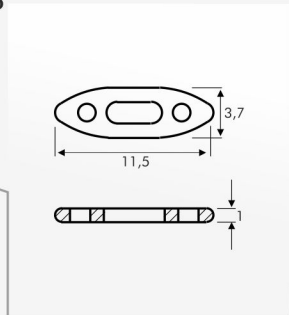
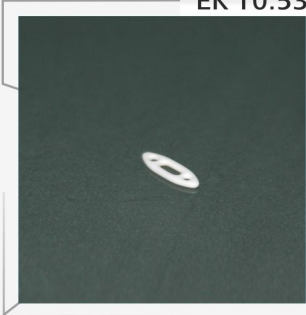

EK 10.537

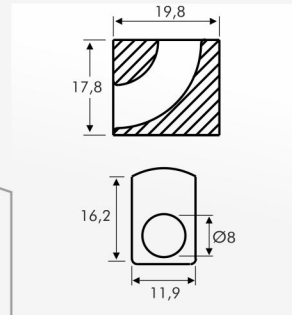
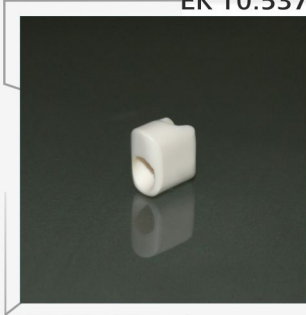

EK 10.538

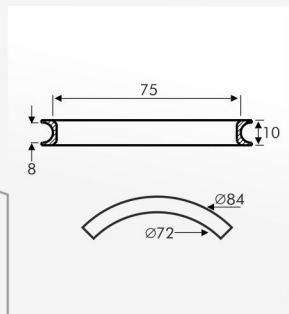

EK 10.540

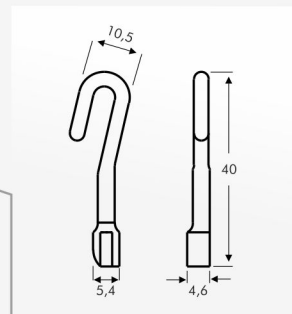
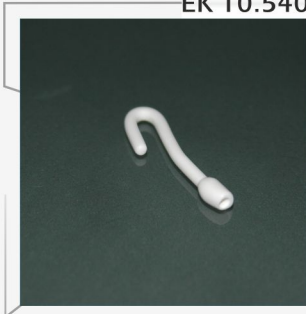

EK 10.541

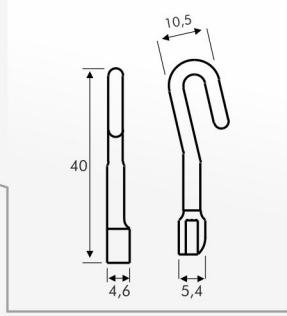

EK 10.542

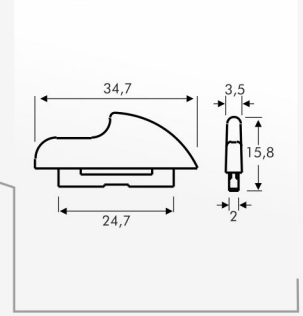

EK 10.543

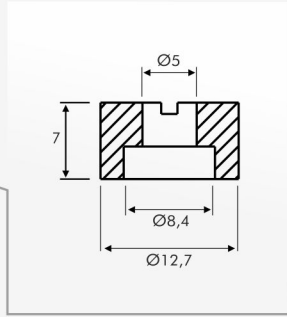
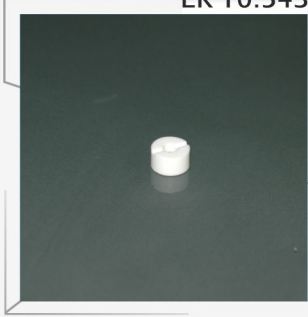

EK 10.544

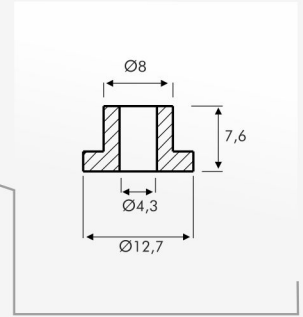
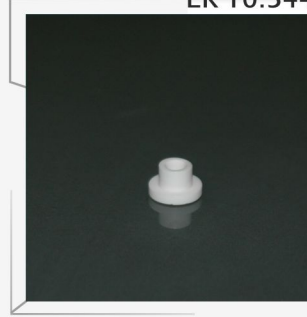

EK 10.545

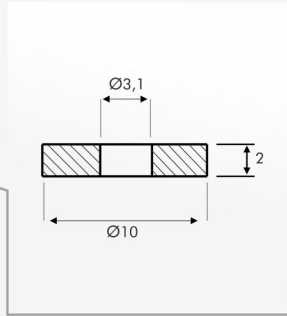
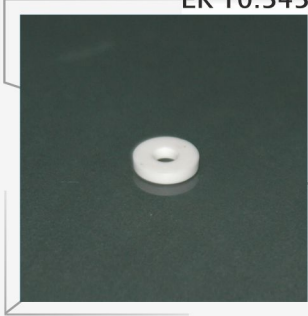

EK 10.546

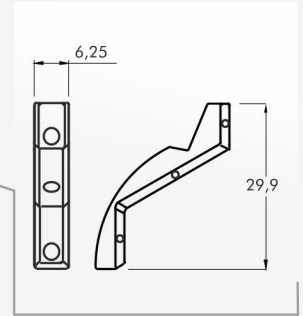

EK 10.547

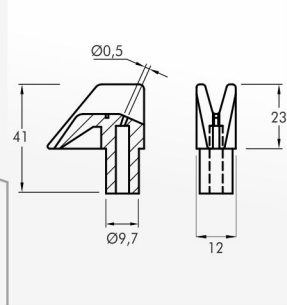

EK 10.548

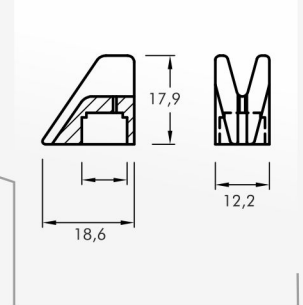
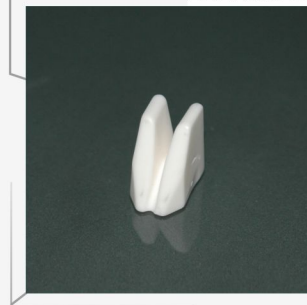

EK 10.549

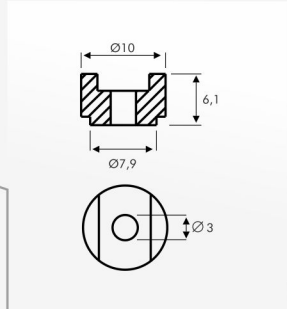
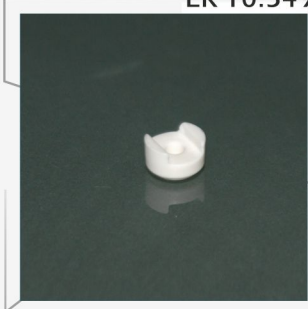

EK 10.550

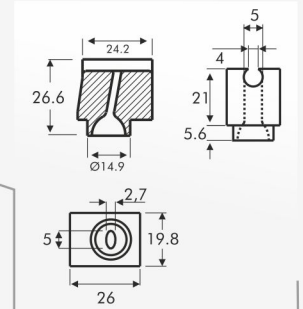

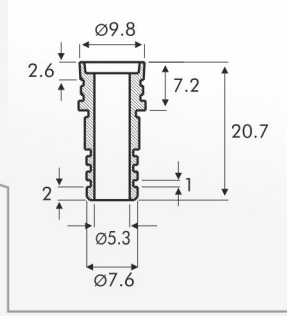
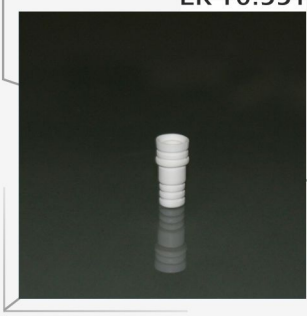
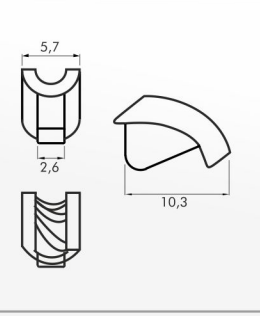
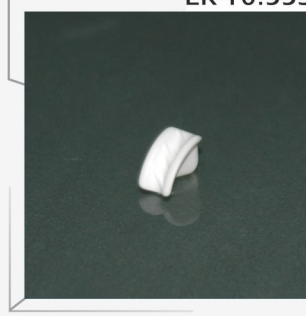
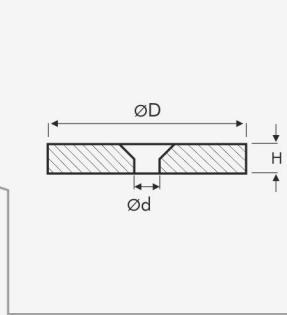
EK 10.551

EK 10.553

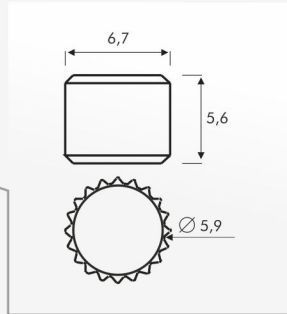
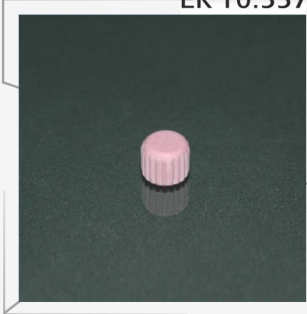
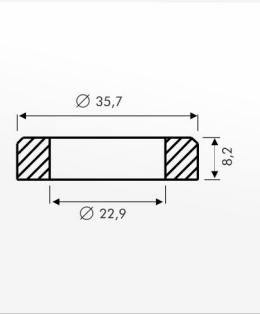
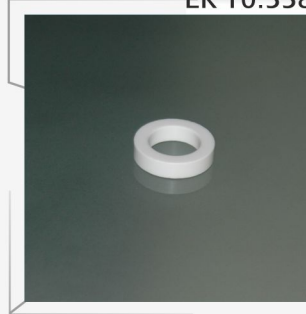
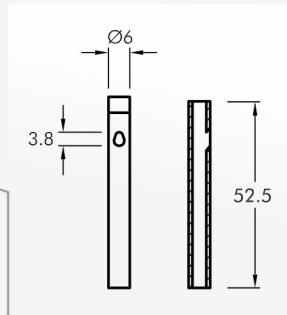
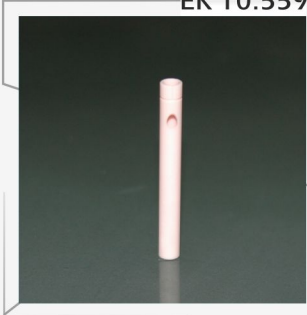
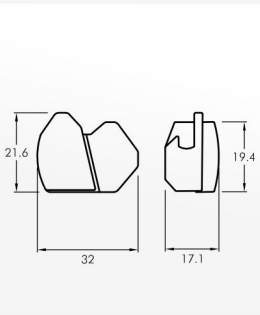
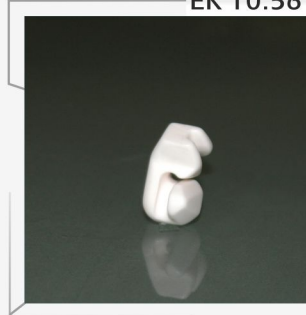
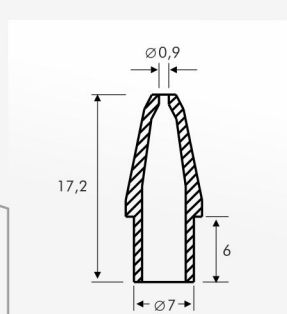
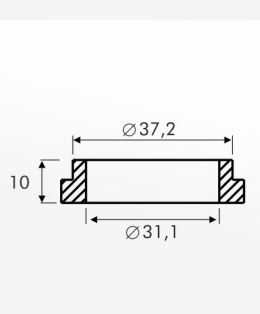
EK 10.

KOD NO	D	d	H
EK-10.552	24,4	1,5	3
EK-10.555	24,4	1,2	3
EK-10.556	24,4	0,8	3

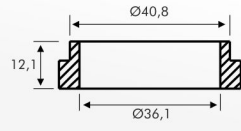
EK 10.557

EK 10.558

EK 10.559

EK 10.561

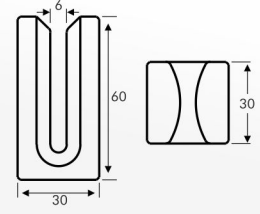
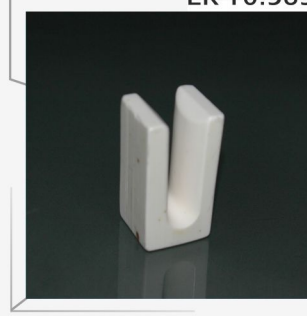
EK 10.562

EK 10.563

EK 10.564



EK 10.565



EK 10.566

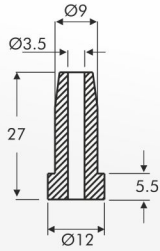

EK 10.567

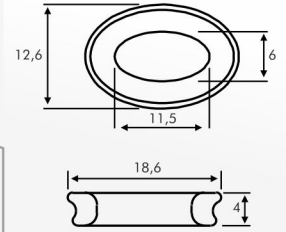
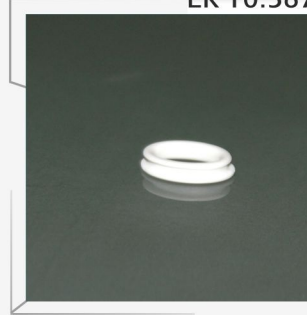

EK 10.568

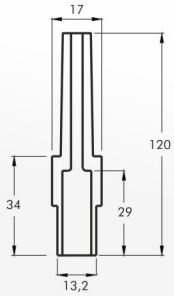

EK 10.569

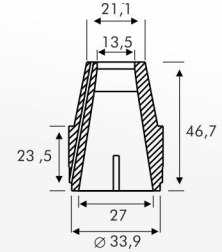

EK 10.570

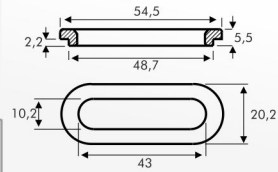

EK 10.571

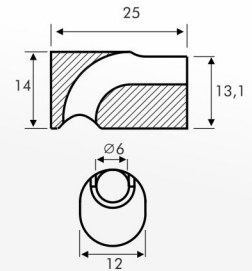
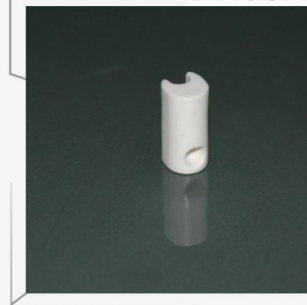

EK 10.572

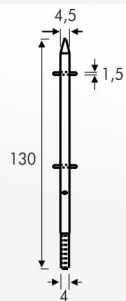

EK 10.573

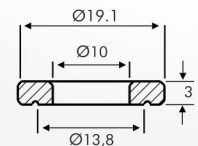

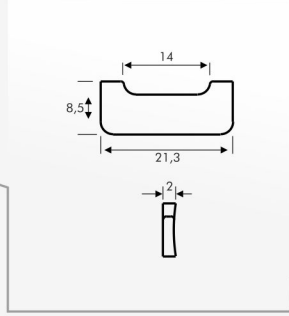
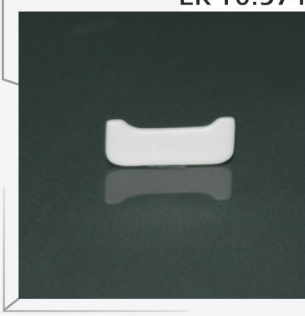
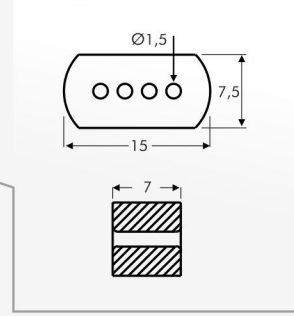
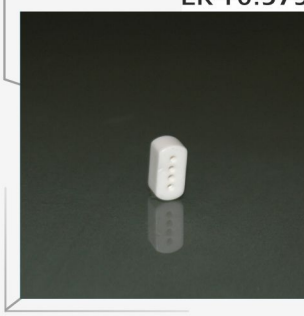
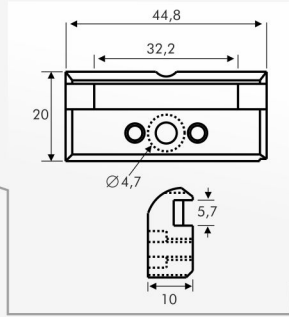
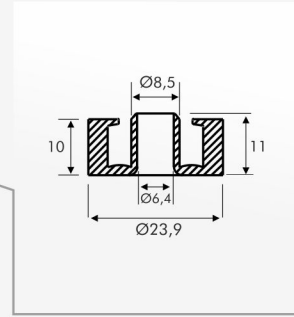
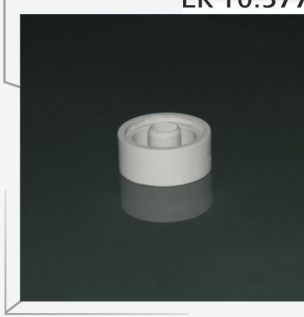
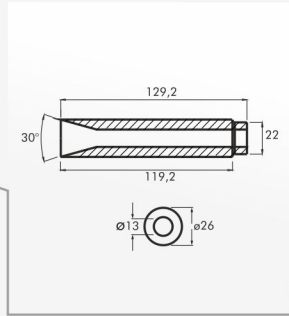
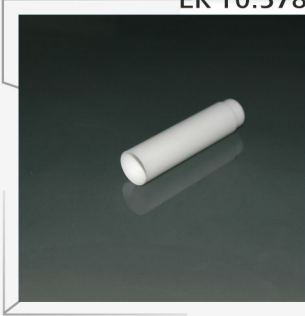
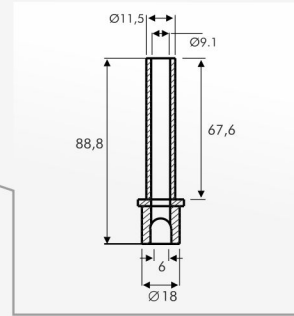
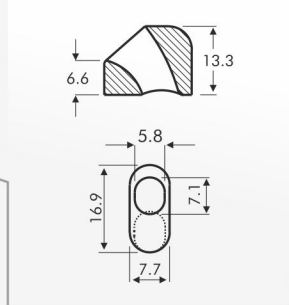
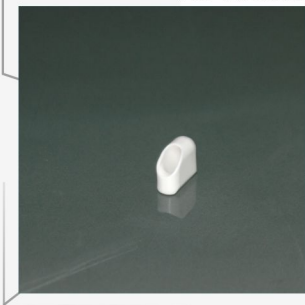
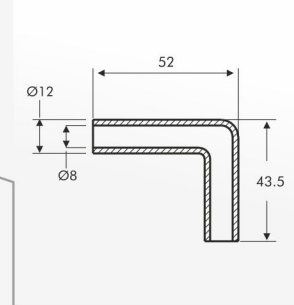
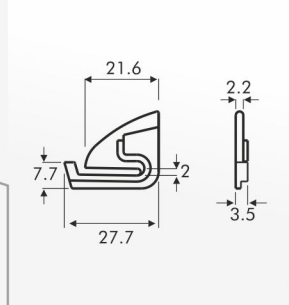
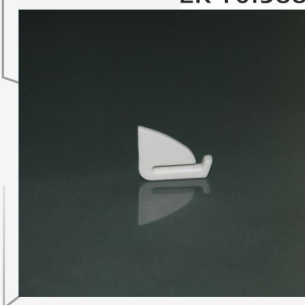
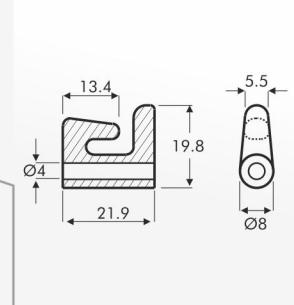
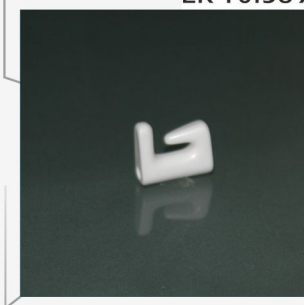
EK 10.574

EK 10.575

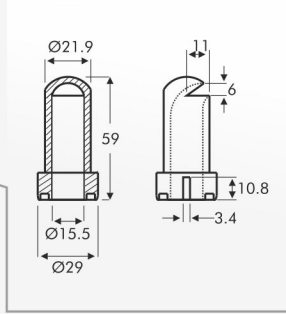
EK 10.576

EK 10.577

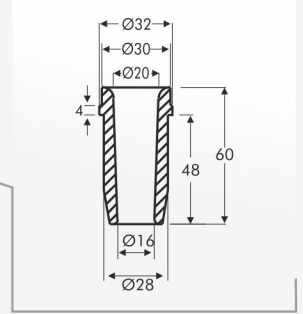
EK 10.578

EK 10.581

EK 10.586

EK 10.587

EK 10.588

EK 10.589

EK 10.590



EK 10.591



EK 10.593

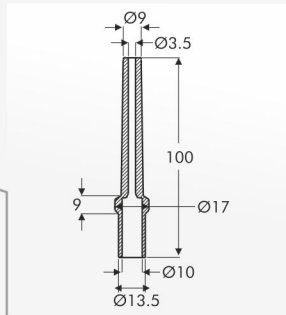

EK 10.594

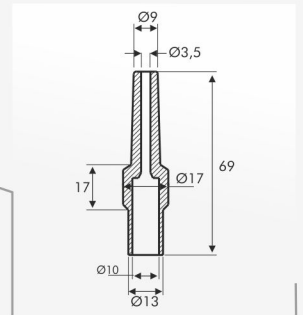

EK 10.595

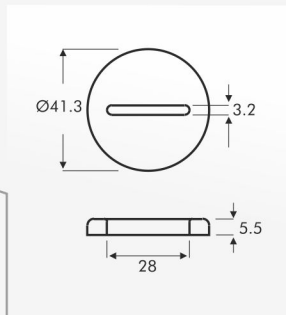

EK 10.596

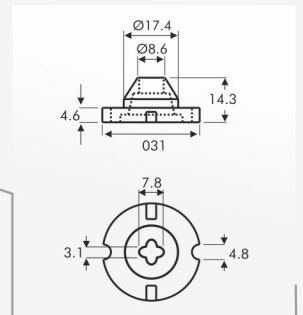

EK 10.597

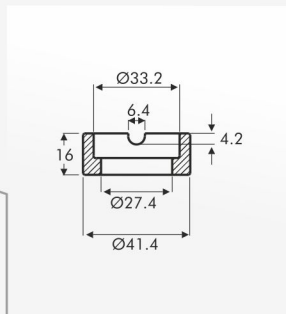

EK 10.598

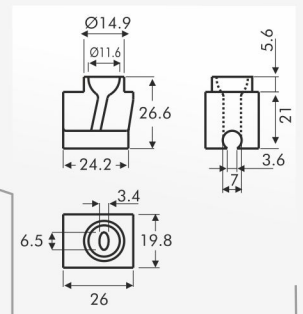
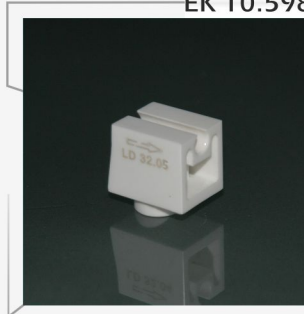

EK 10.599

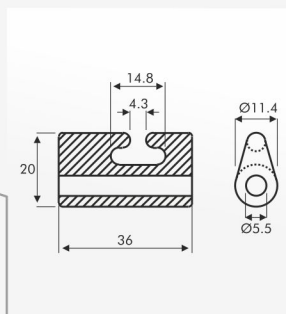

EK 10.600

