

# САМОЗАПРАВЛЯЮЩИЕСЯ НИТЕВОДИТЕЛИ

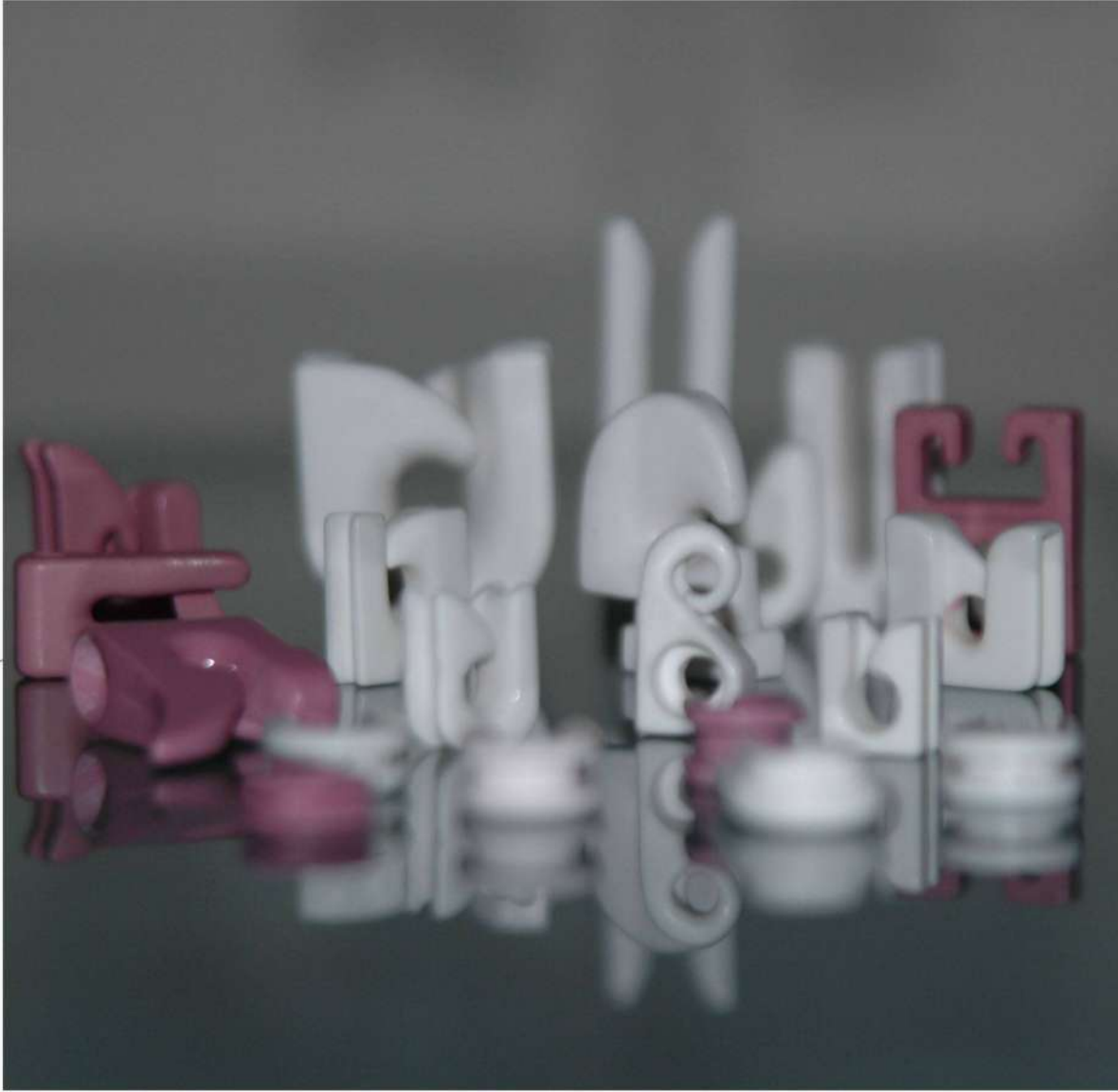

EK.06  
TIRNAKLI KILAVUZLAR  
TRAP GUIDES

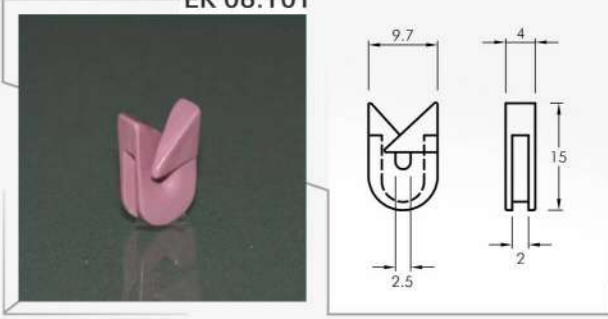
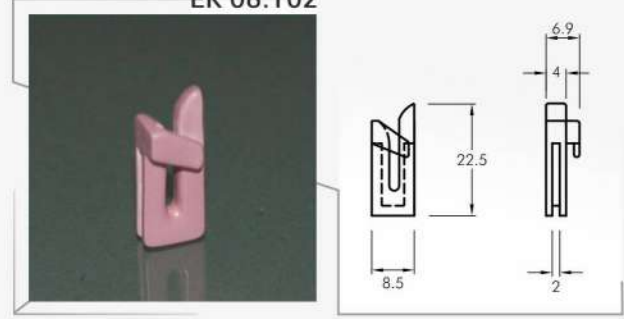
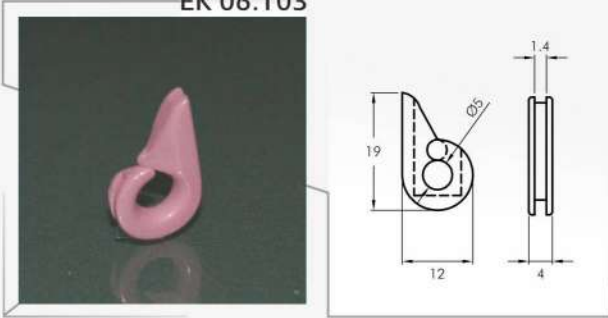
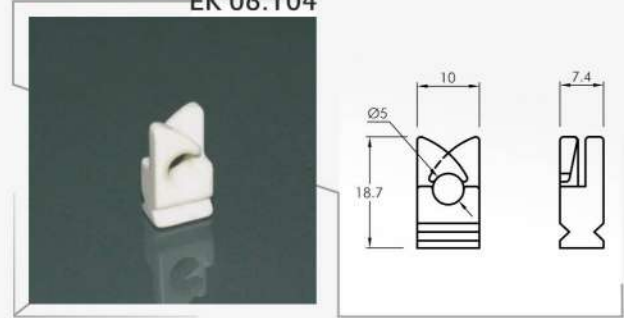
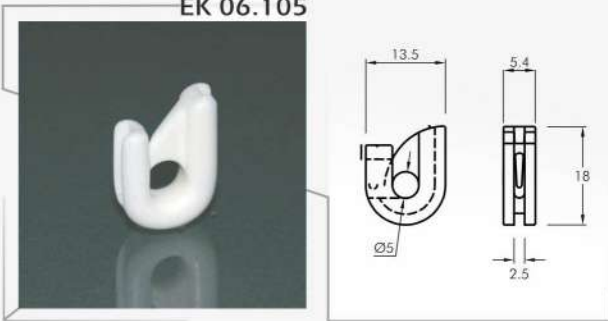
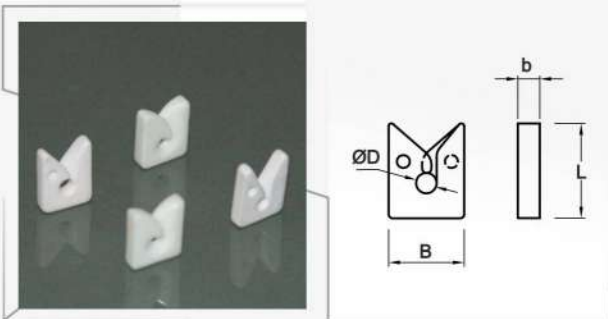
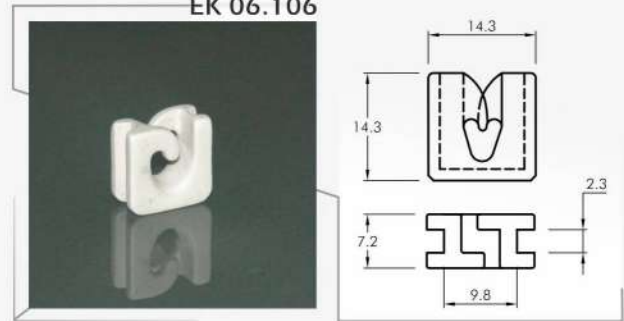

**EK 06.101**

**EK 06.102**

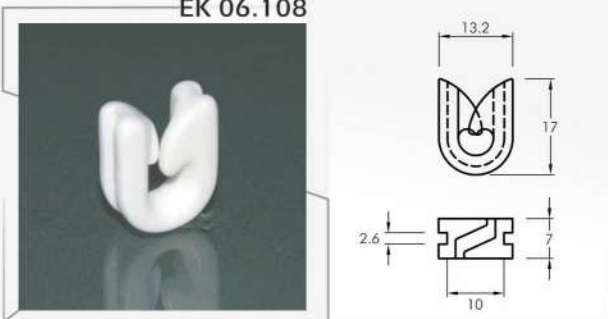
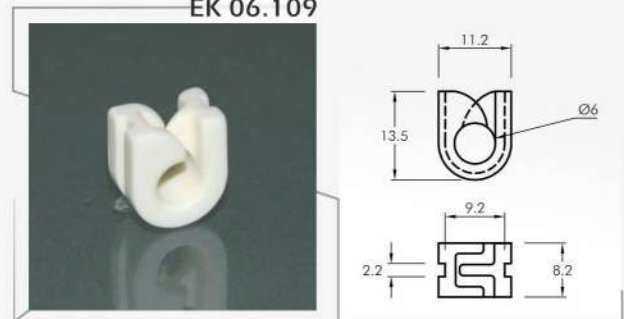
**EK 06.103**

**EK 06.104**

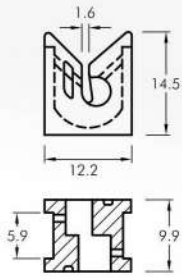
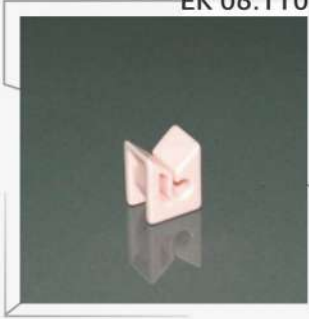
**EK 06.105**

**EK 06.106**

KOD NO	ØD	L	B	b
EK.06.107	2.8	13.1	10.1	2.9
EK.06.148	1.8	13.5	10.3	2.7
EK.06.159	1.8	12	10	3.1
EK.06.160	1.3	11.8	10	3

**EK 06.108**

**EK 06.109**

EK 06.110

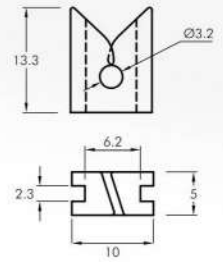
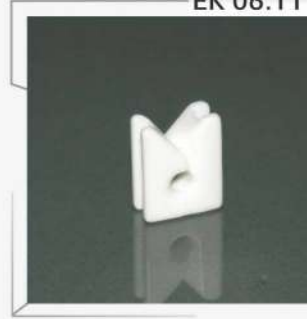

EK 06.111



EK 06.112

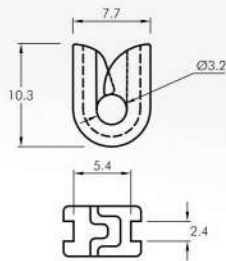

EK 06.113

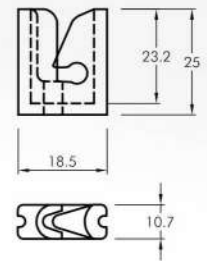

EK 06.114

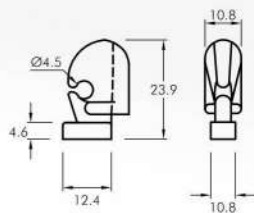

EK 06.115

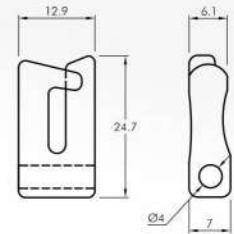

EK 06.116

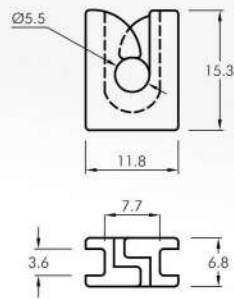

EK 06.117

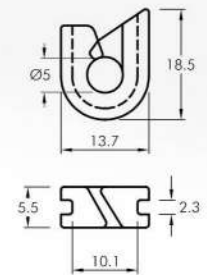

EK 06.118

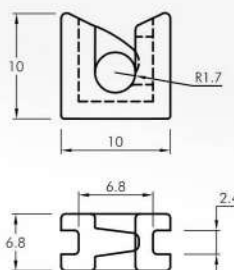

EK 06.119

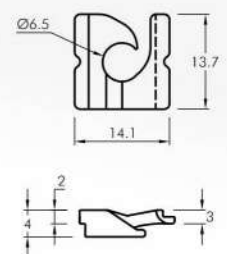

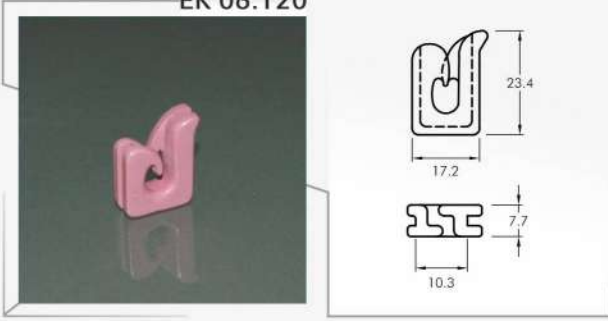
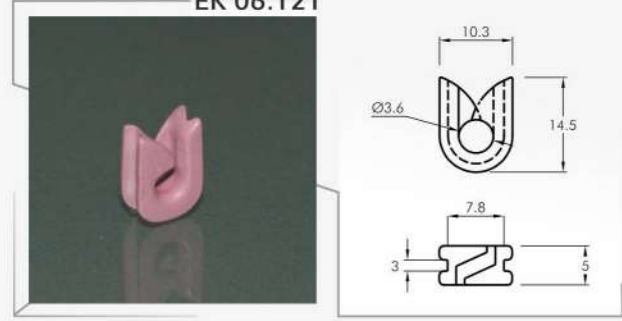
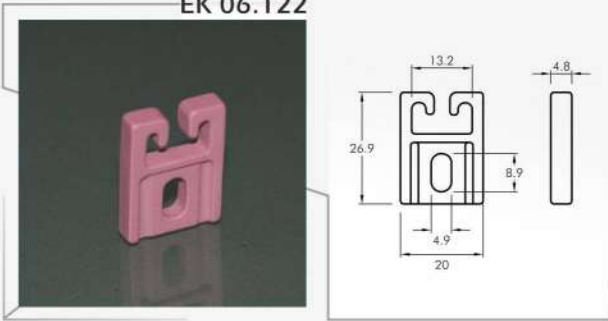
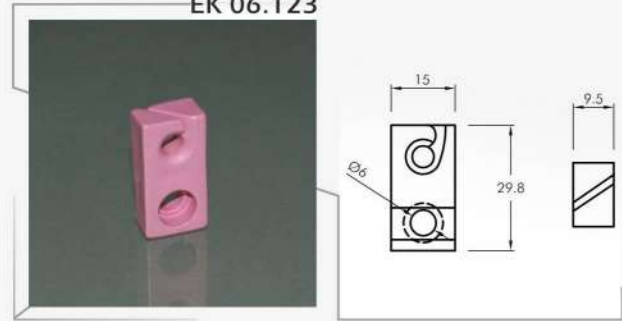
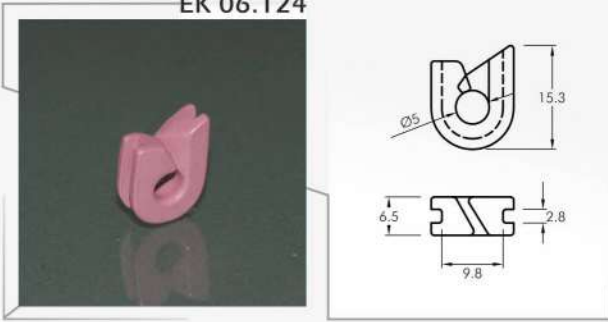
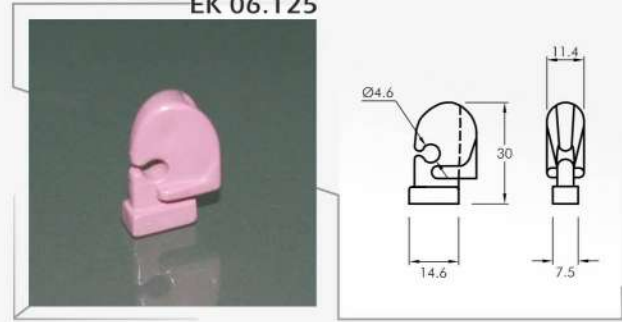
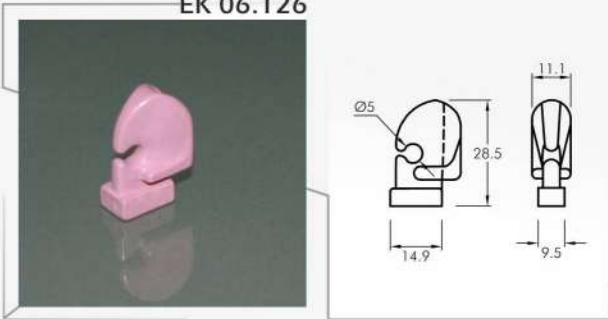
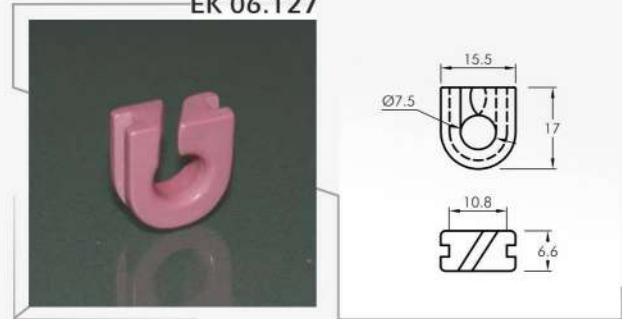
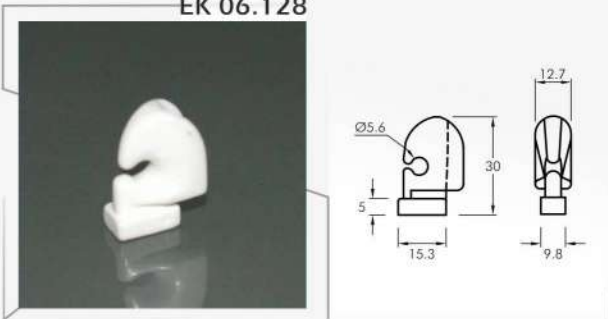
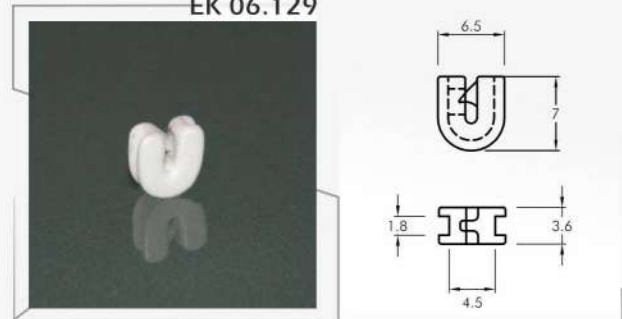
**EK 06.120**

**EK 06.121**

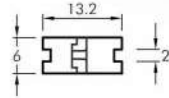
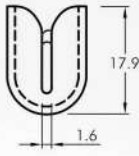
**EK 06.122**

**EK 06.123**

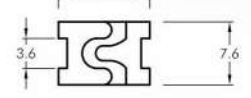
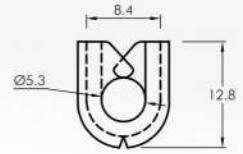
**EK 06.124**

**EK 06.125**

**EK 06.126**

**EK 06.127**

**EK 06.128**

**EK 06.129**

EK 06.130



EK 06.131



EK 06.132

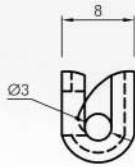
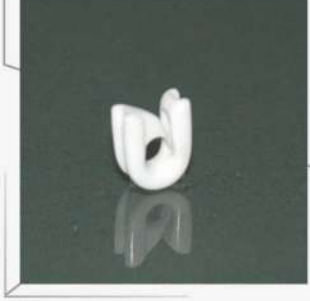

EK 06.133

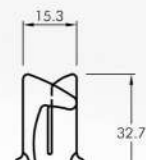

EK 06.134

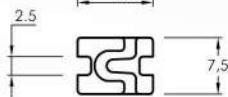
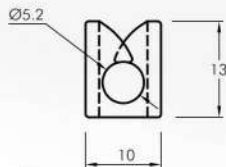

EK 06.135

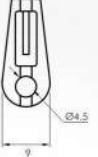
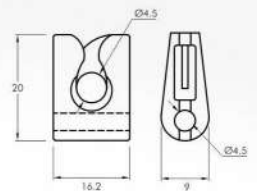

EK 06.136

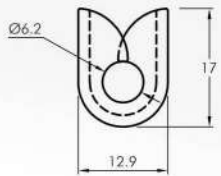

EK 06.137

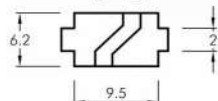
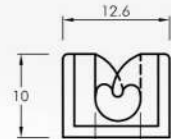

EK 06.138

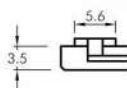
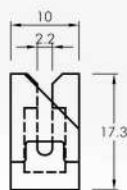

EK 06.139

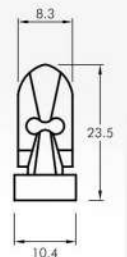

EK 06.140

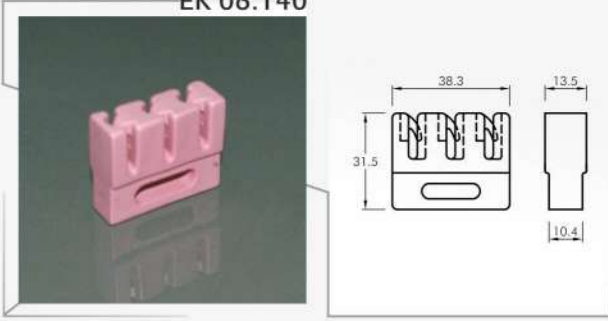

EK 06.141

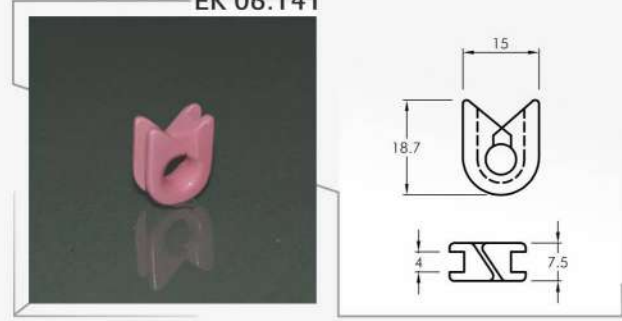

EK 06.142

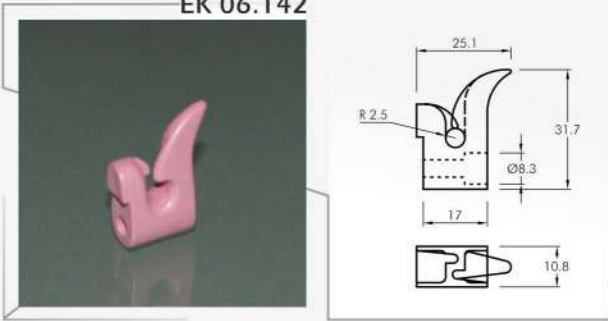

EK 06.143

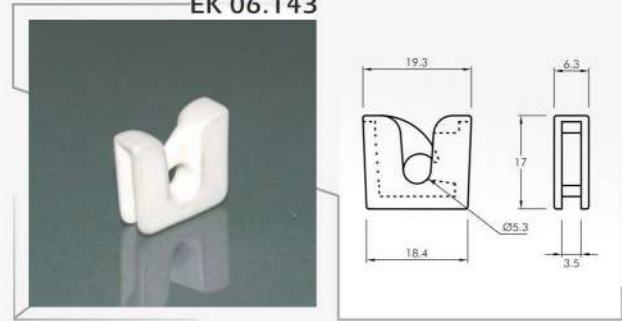

EK 06.144

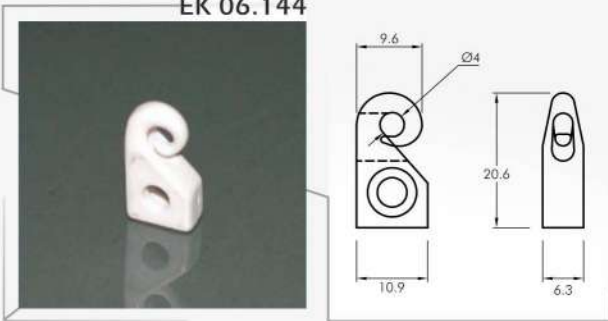

EK 06.145

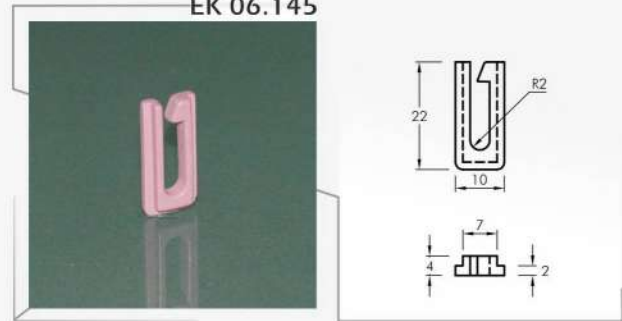

EK 06.146

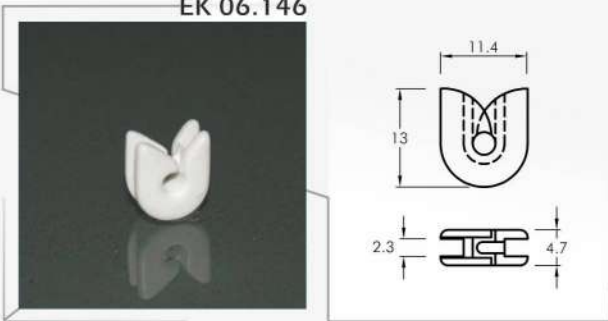

EK 06.147

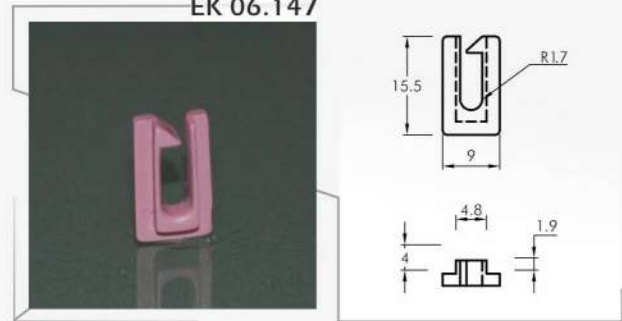

EK 06.149

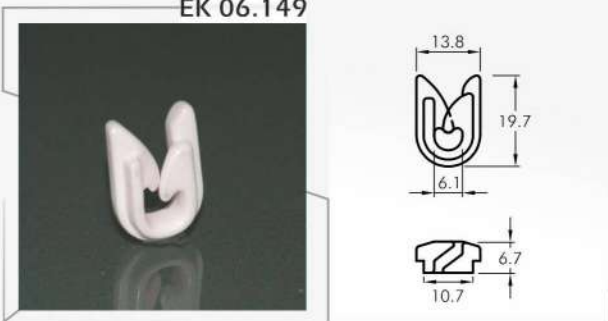

EK 06.150

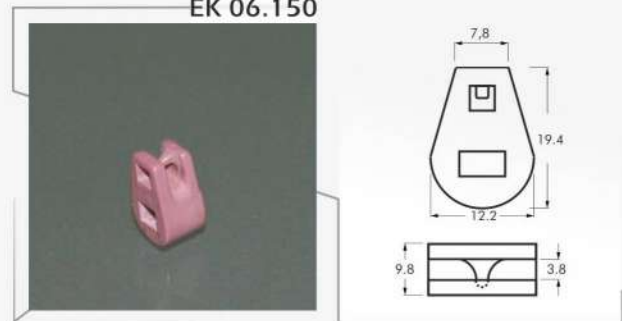

EK 06.151

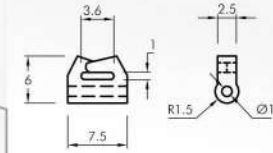
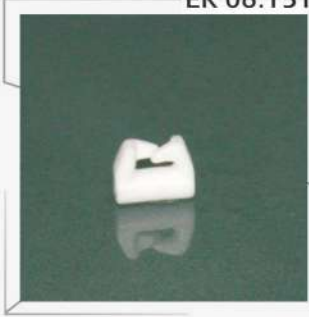

EK 06.152

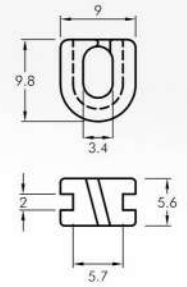

EK 06.153

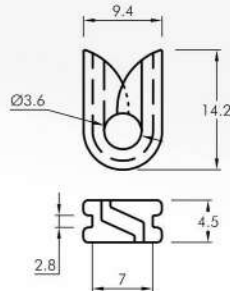

EK 06.154

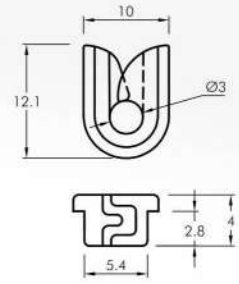

EK 06.155

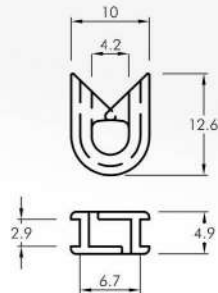
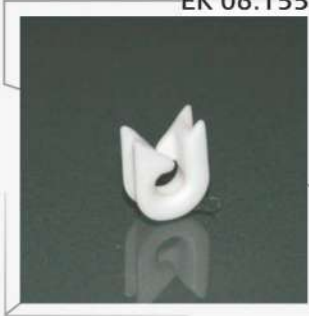

EK 06.156

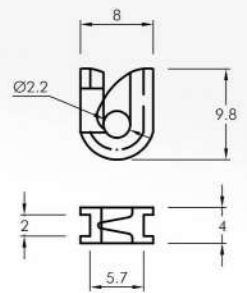
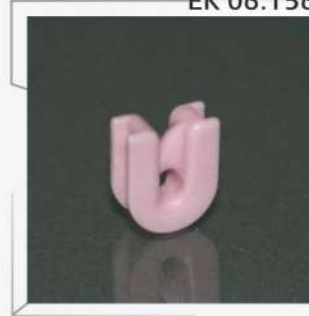

EK 06.157

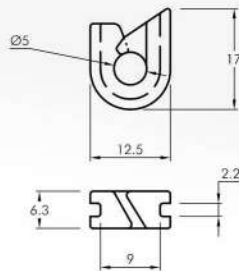
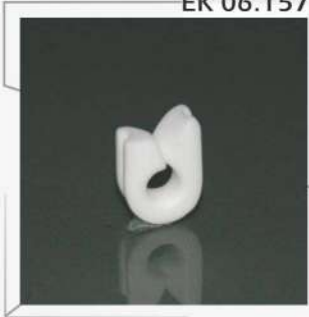

EK 06.158

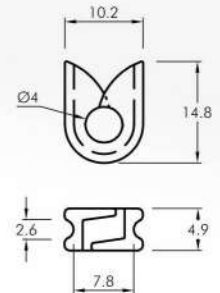

EK 06.161

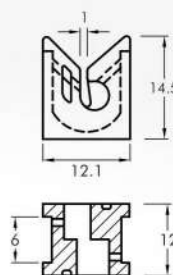
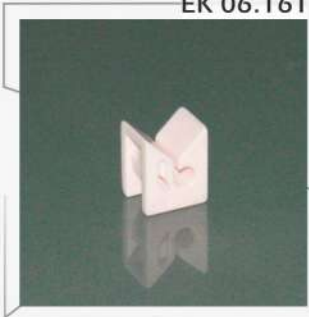

EK 06.162

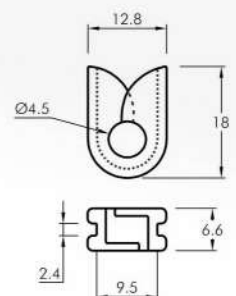

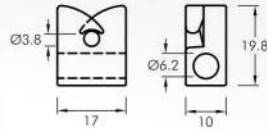
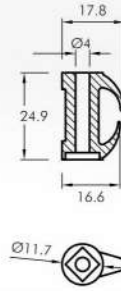
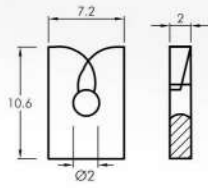
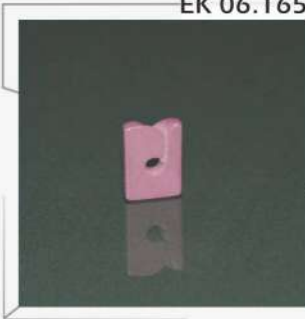
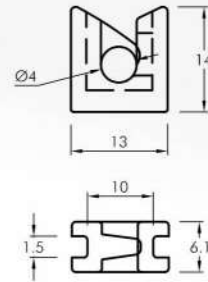
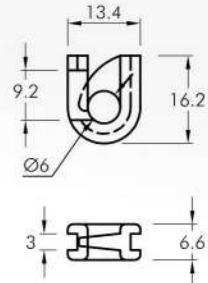
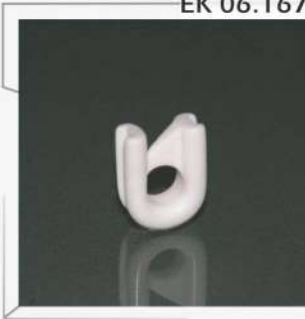
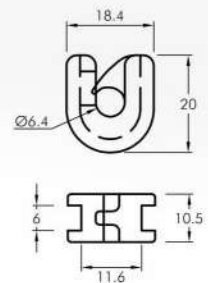
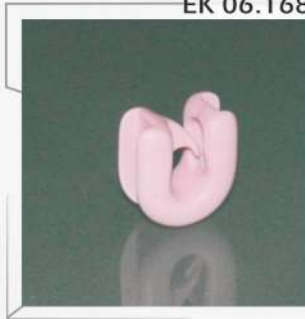
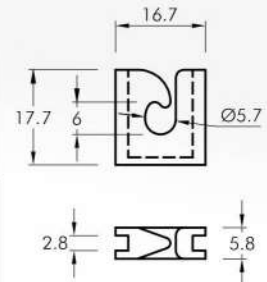
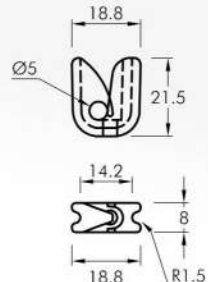
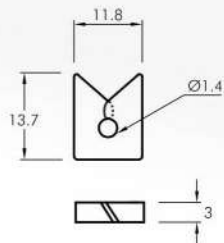
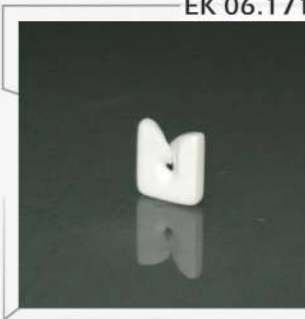
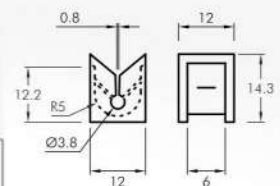

**EK 06.163**

**EK 06.164**

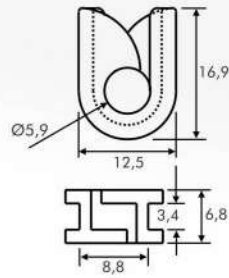
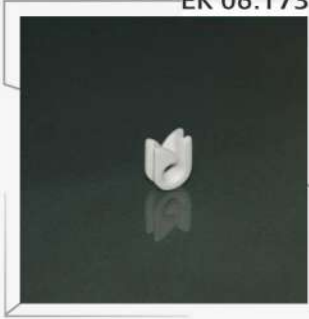
**EK 06.165**

**EK 06.166**

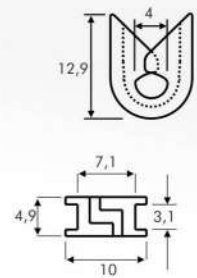
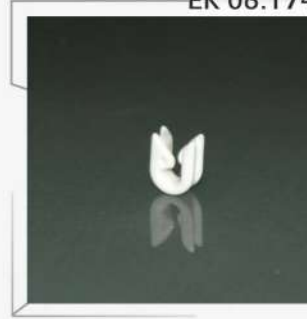
**EK 06.167**

**EK 06.168**

**EK 06.169**

**EK 06.170**

**EK 06.171**

**EK 06.172**

EK 06.173



EK 06.174



EK 06.175

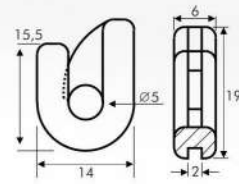
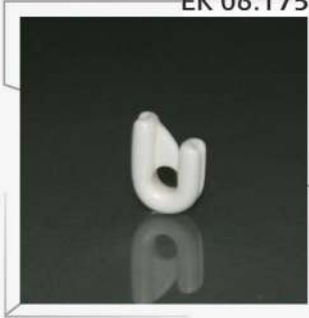

EK 06.176

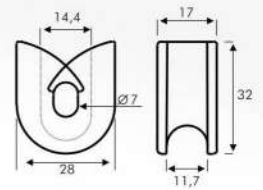

EK 06.177

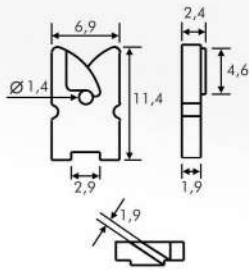
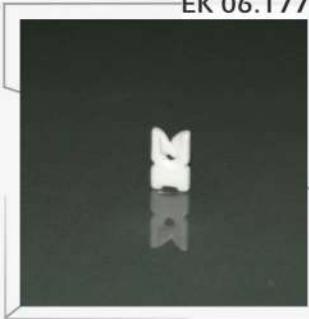

EK 06.178

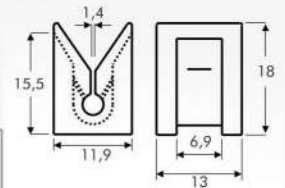
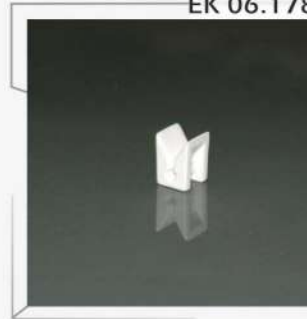

EK 06.179

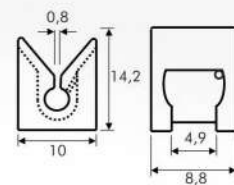

EK 06.180

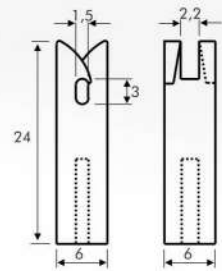

EK 06.181

