

НАПРАВЛЯЮЩИЕ РОЛИКИ



EK.02

EK.02 MAKARA KILAVUZLAR
ROLLING GUIDES



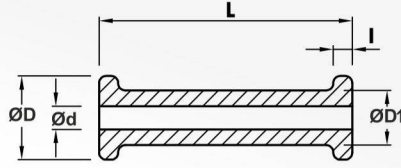
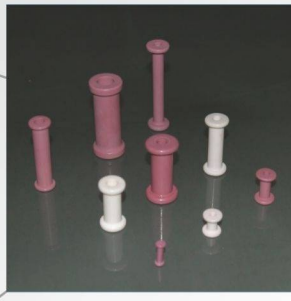

KOD NO	ØD	ØD1	Ød	L	I
EK.02.101	13	7	4	20.4	2.2
EK.02.102	14	10.5	6.8	50.5	2.3
EK.02.103	21	13.9	6	41	4.5
EK.02.104	13	8	4	62.7	5
EK.02.105	22.5	18	11	55	5
EK.02.106	16	7	5	24.5	5.4
EK.02.107	16	10	5.4	40.8	3.2

KOD NO	ØD	ØD1	Ød	L	I
EK.02.108	16.5	11	7	32.5	4
EK.02.113	16	8	5	66.3	3.3
EK.02.164	6	3.7	1.3	15.9	1.5
EK.02.165	12	6.6	3.5	14	2.2
EK.02.343	12.9	10	6.2	21.9	2
EK.02.352	11.7	10.2	5.3	21.4	2

EK.02.109

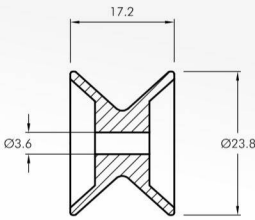
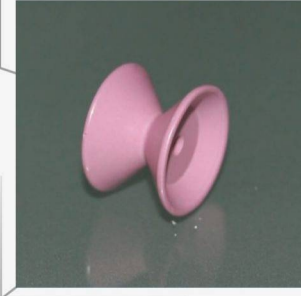

EK.02.111

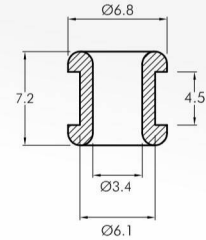
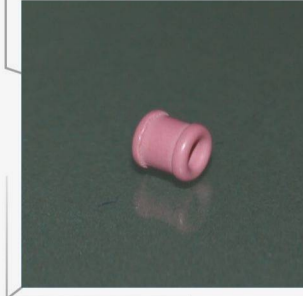

EK.02.112

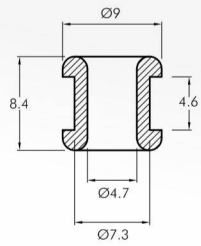

EK.02.114

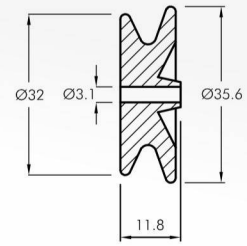

EK.02.115

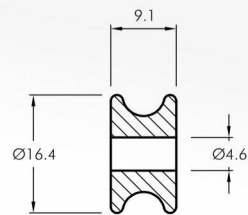

EK.02.116

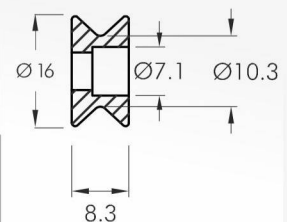

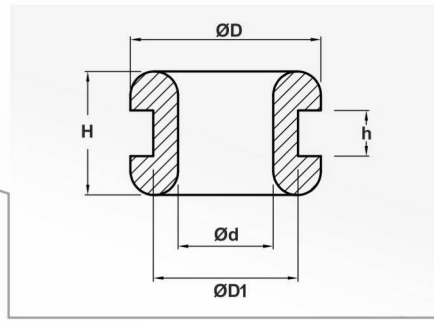

KOD NO	ØD	ØD1	Ød	H	h
EK.02.110	9.1	7.7	4.7	4.9	1.3
EK.02.111	6.8	6.1	3.4	7.2	4.5
EK.02.112	9	7.3	4.7	8.4	4.6
EK.02.125	13	-	6.8	6.2	-
EK.02.126	13	-	6.9	5.8	-
EK.02.127	9.8	-	4.8	3.4	-
EK.02.136	18.5	-	9.8	6.9	-
EK.02.137	7	5.4	3.3	6.1	1.6
EK.02.141	9.6	-	5	5	-
EK.02.146	5.7	4.8	3	2.8	-
EK.02.150	8.2	6.8	4	2.9	1.1
EK.02.156	12.4	-	6.9	9	-
EK.02.121	24	20	16.6	20	16
EK.02.122	13.4	12.4	8.6	10	6.1
EK.02.162	7.8	6.3	4.7	5.2	2.4
EK.02.186	8.9	7.4	4.5	4.4	1.5
EK.02.195	10.2	7.1	5.3	5.2	2.1
EK.02.196	7.9	5.9	3.2	4.4	1.9

KOD NO	ØD	ØD1	Ød	H	h
EK.02.187	9.5	6.9	4.4	5.6	4.5
EK.02.190	10.5	8.2	5	5.5	2.3
EK.02.197	8	6.9	3.1	5.2	0.9
EK.02.198	8.9	7.3	3.2	4.8	3
EK.02.199	10.4	7	4.7	4	2.2
EK.02.200	8.9	7.2	3.4	5.7	3
EK.02.304	20	17.5	13.1	5.1	1.8
EK.02.311	21.5	18.2	16.3	6.4	2
EK.02.319	24	19.6	15.7	5.6	3.1
EK.02.327	33	29.7	21.9	4	2.9
EK.02.386	19.8	15.8	10.2	10	4.5
EK.02.187	9.5	7	4.3	8.7	4.5
EK.02.355	14.8	11.3	8	6.8	1.6
EK.02.357	10.5	8.1	4.3	4.4	1.5
EK.02.377	24	19.5	14.9	6.9	2.9
EK.02.378	18.1	15.1	10.4	5.9	2.1
EK.02.384	8.6	6.1	3.7	5.6	1.9
EK.02.386	19.8	16	10.3	9.9	2.1

EK.02.117

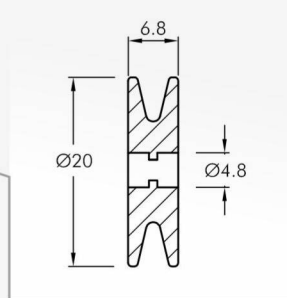
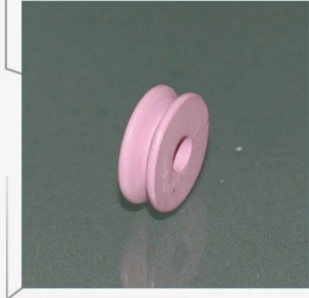

EK.02.118

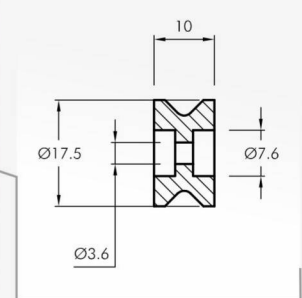

EK.02.119

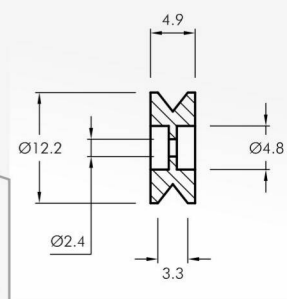
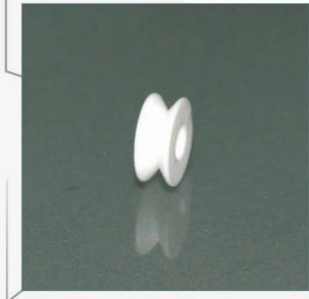

EK.02.120

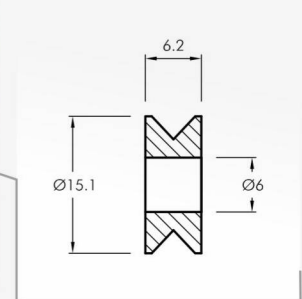

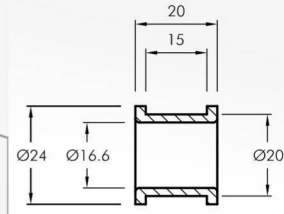
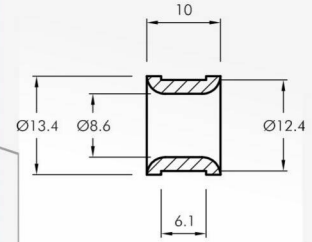
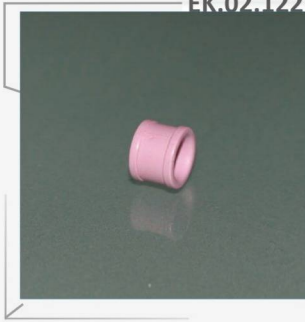
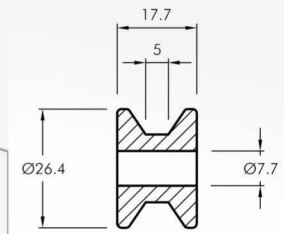
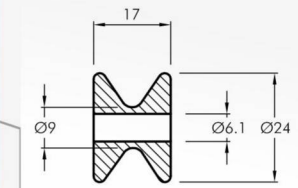
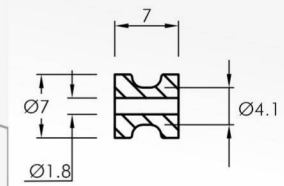
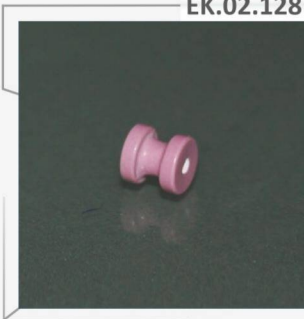
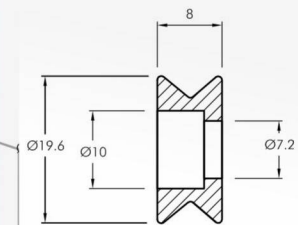
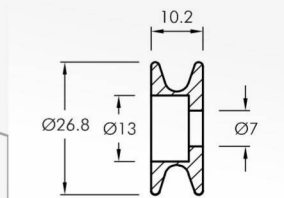
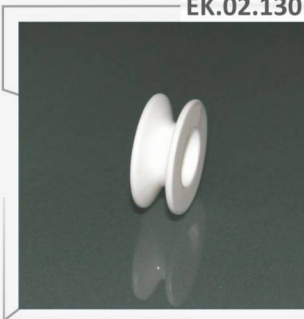
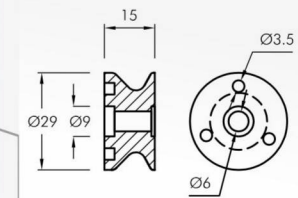
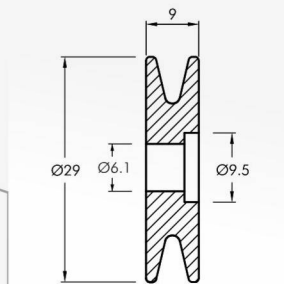
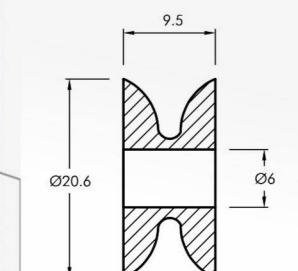
EK.02.121

EK.02.122

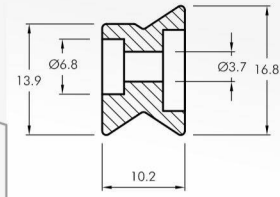
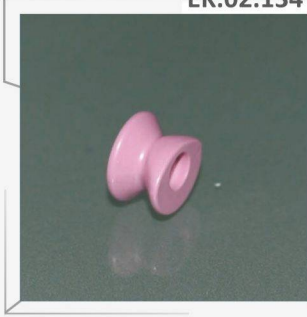
EK.02.123

EK.02.124

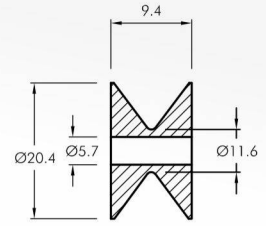
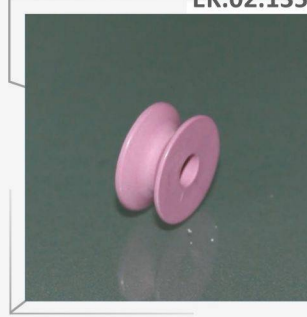
EK.02.128

EK.02.129

EK.02.130

EK.02.131

EK.02.132

EK.02.133

EK.02.134



EK.02.135



EK.02.138

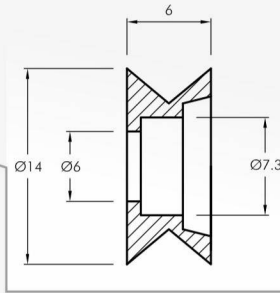

EK.02.139

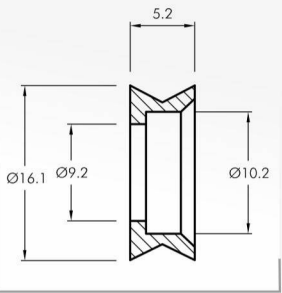

EK.01.140

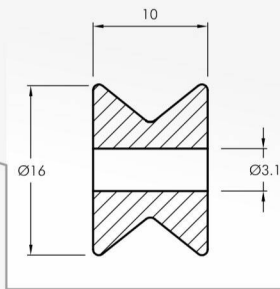
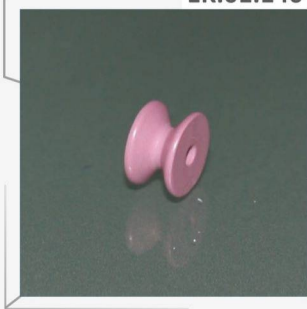

EK.02.142

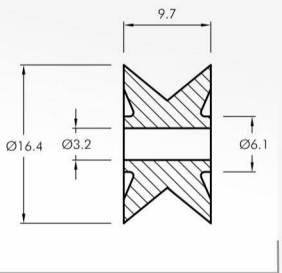
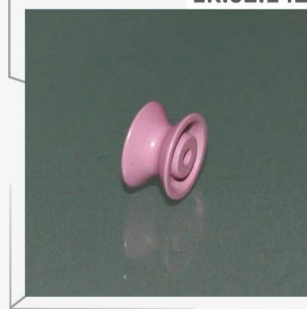

EK.02.143

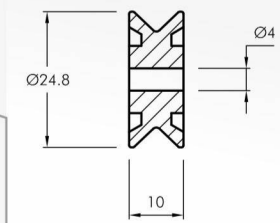

EK.02.144

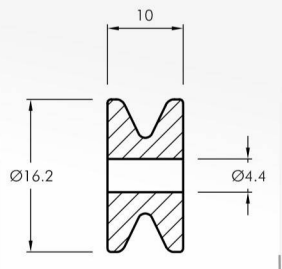
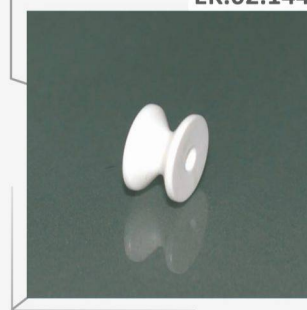

EK.02.145

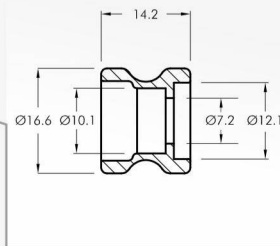
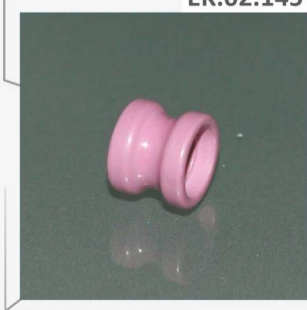

EK.02.147

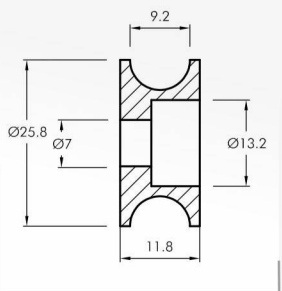



EK.02.148

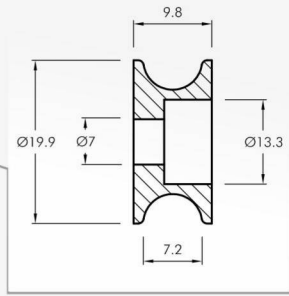
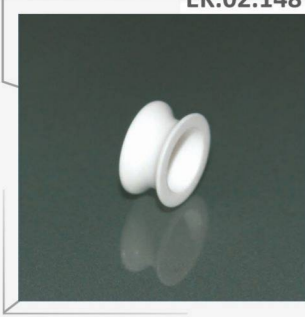

EK.02.149

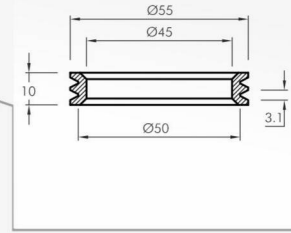

EK.02.151

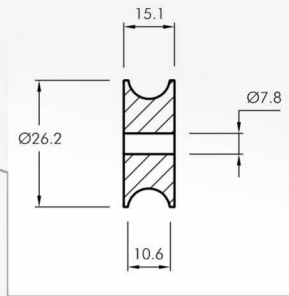
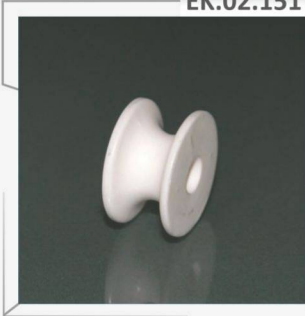

EK.02.152

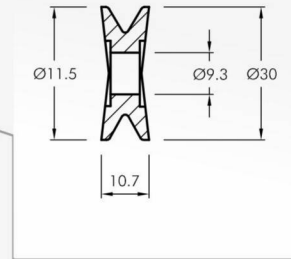

EK.02.153

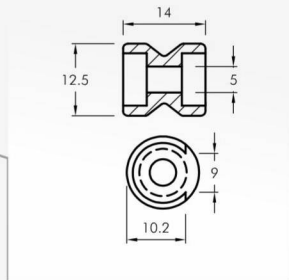

EK.02.154

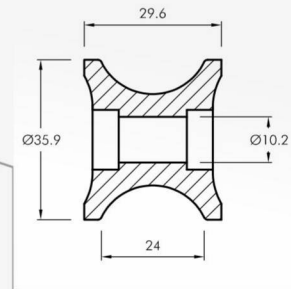

EK.02.155

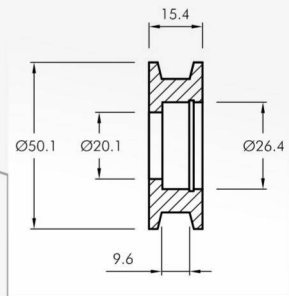

EK.02.157

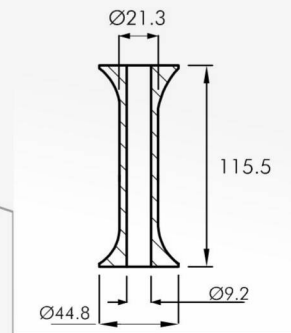

EK.02.158

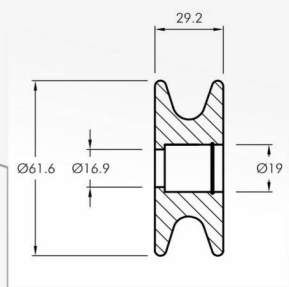

EK.02.159

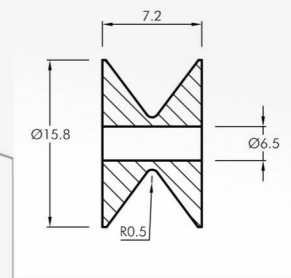
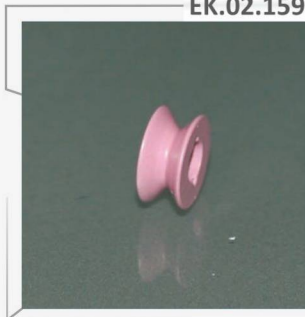

EK.02.160

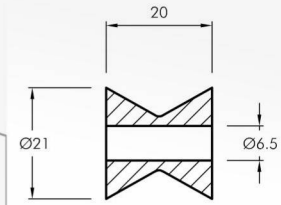

EK.02.161

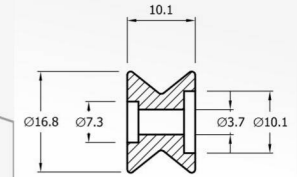
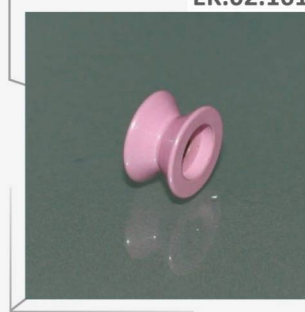

EK.02.163

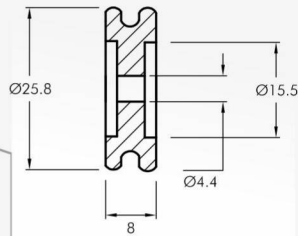

EK.02.166

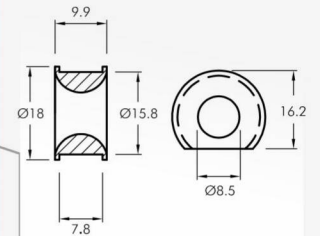
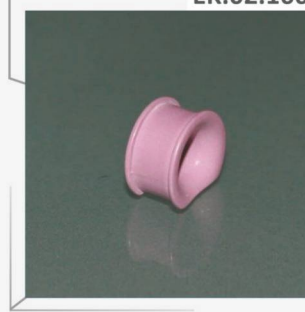

EK.01.167

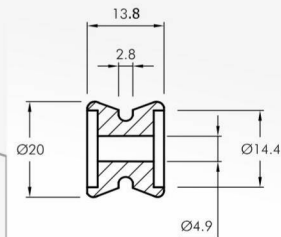

EK.02.168

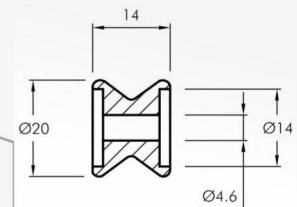

EK.02.169

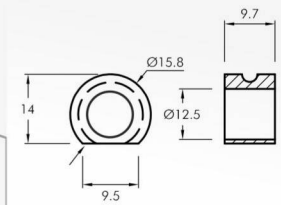
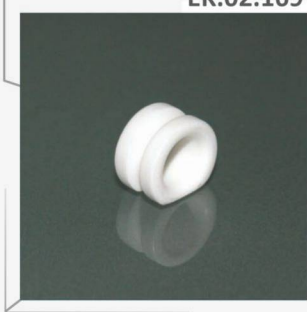

EK.02.170

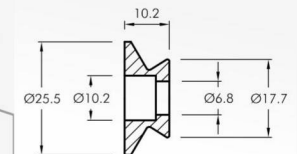

EK.02.171

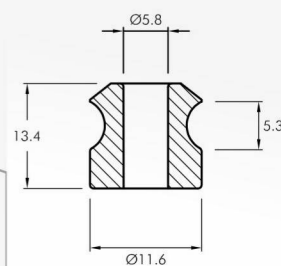
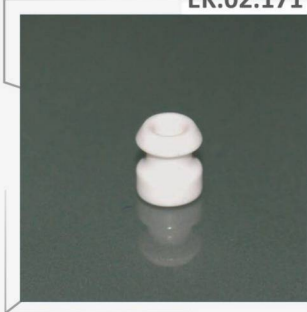

EK.02.172

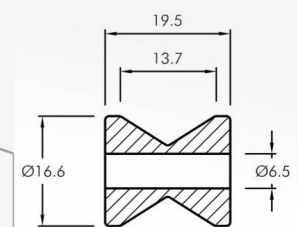



EK.02.173

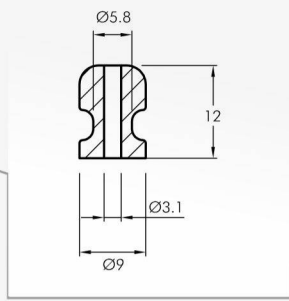
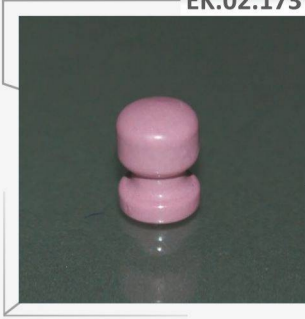

EK.02.176

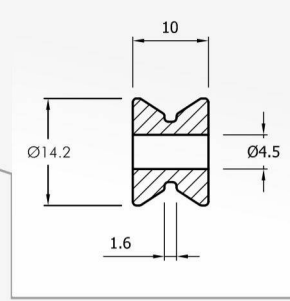

EK.02.177

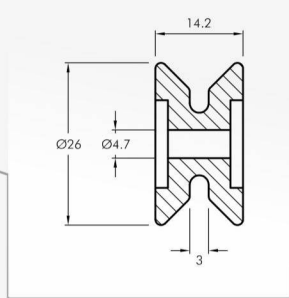
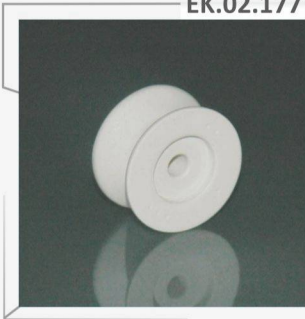

EK.02.178

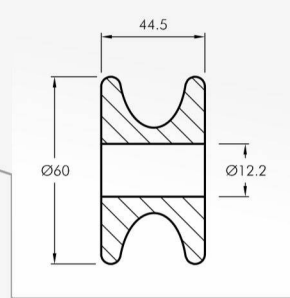
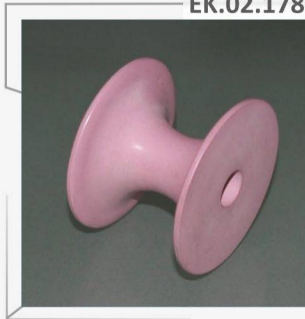

EK.02.179

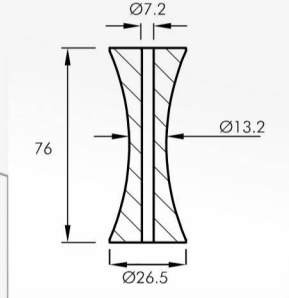

EK.02.180

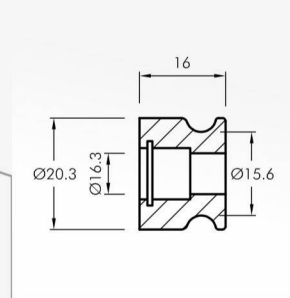

EK.02.181

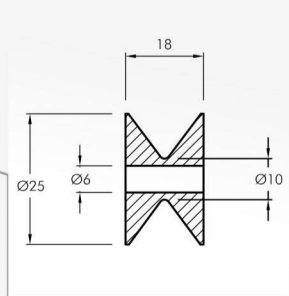

EK.02.182

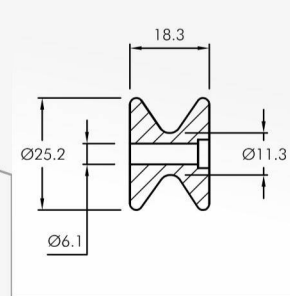

EK.02.183

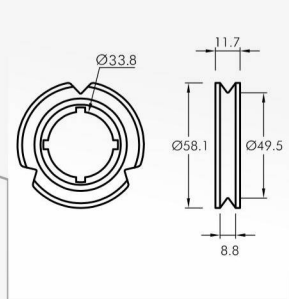

EK.02.184

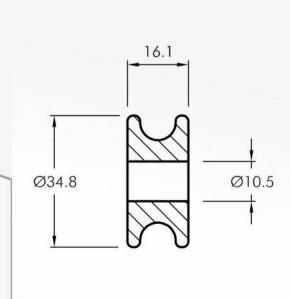

EK.02.185

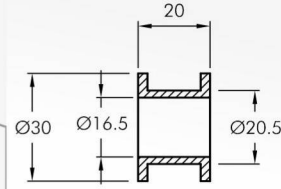
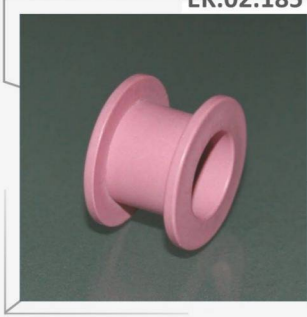

EK.02.187

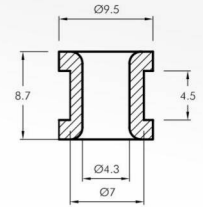
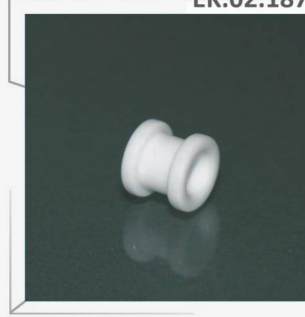

EK.02.188

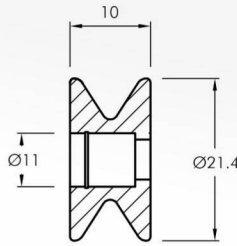

EK.02.189

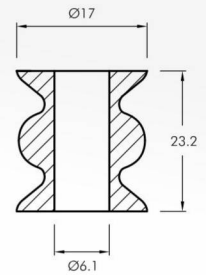

EK.02.193

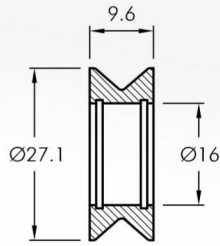
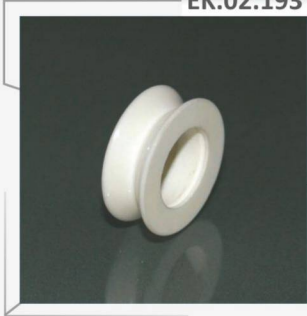

EK.02.194

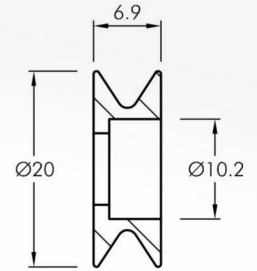
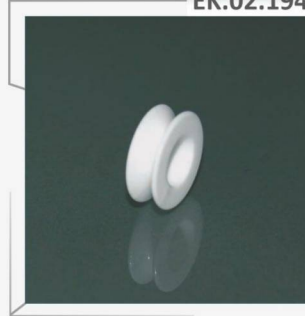

EK.02.302

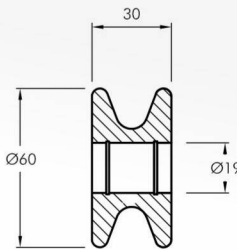

EK.02.303

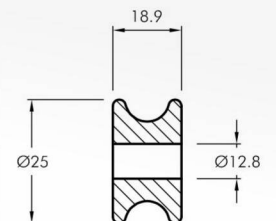

EK.02.305

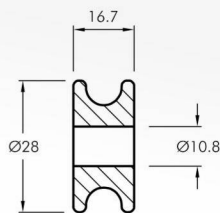

EK.02.306

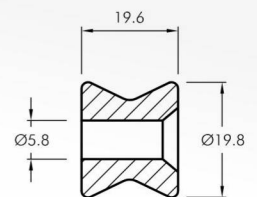
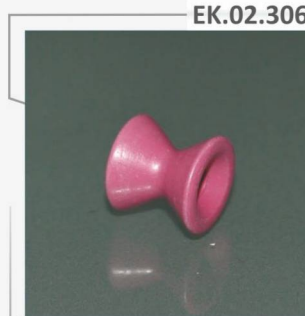



EK.02.307

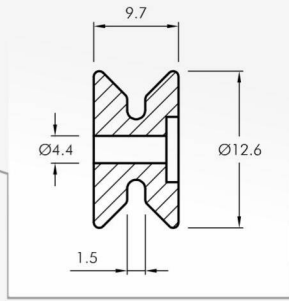
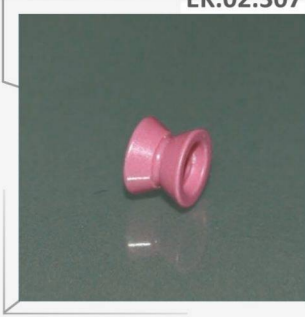

EK.02.308

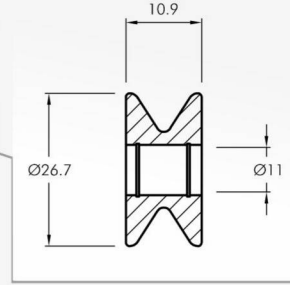

EK.02.309

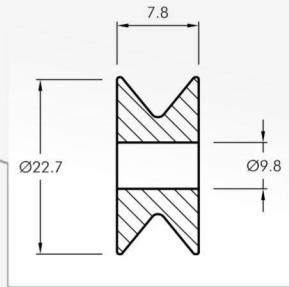
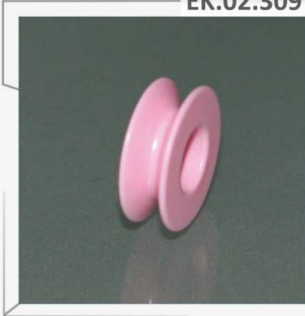

EK.02.310

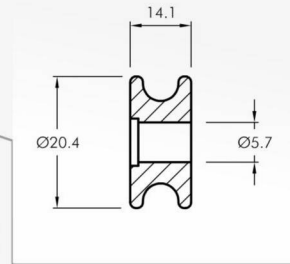

EK.02.312

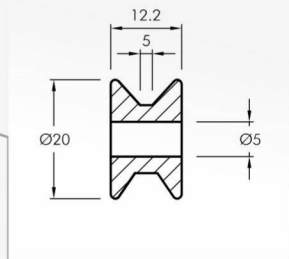

EK.02.313

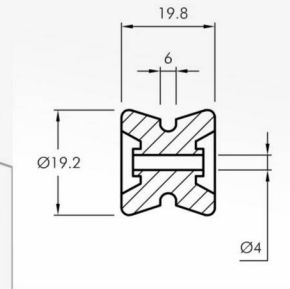

EK.02.314

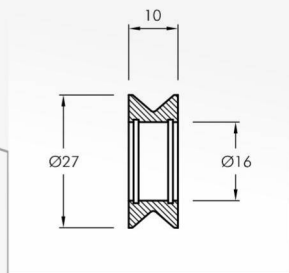
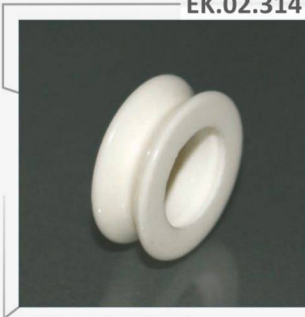

EK.02.315

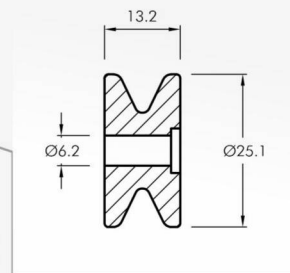

EK.02.316

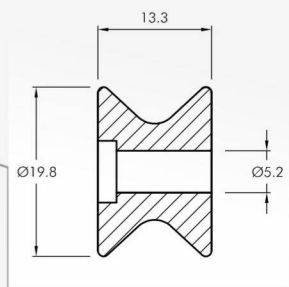

EK.02.317

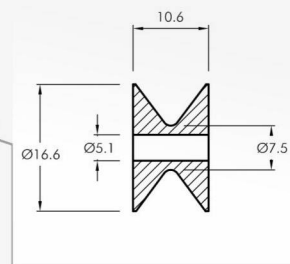
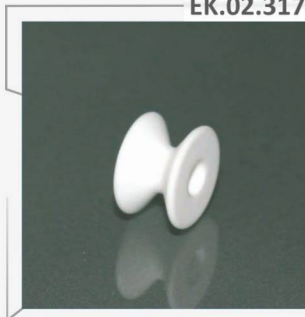

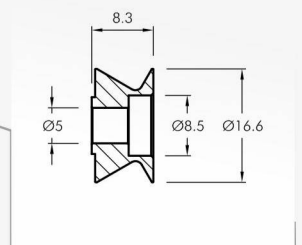
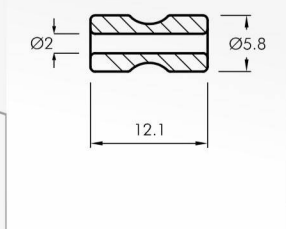
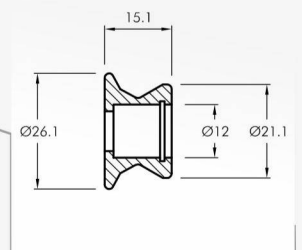
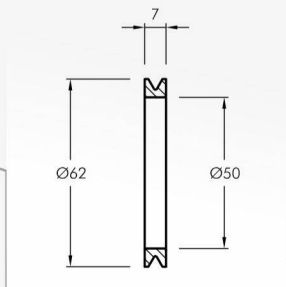
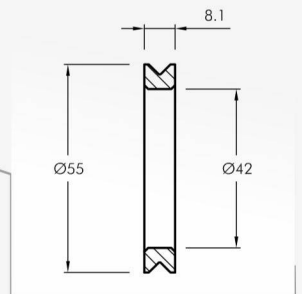
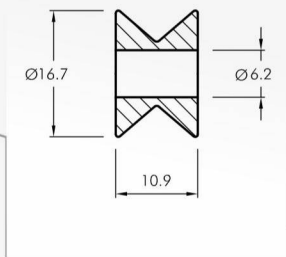
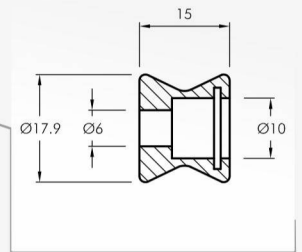
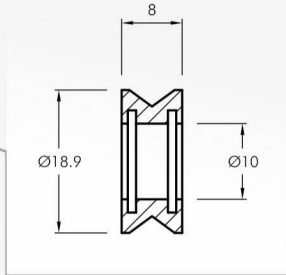
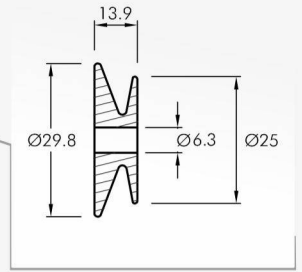
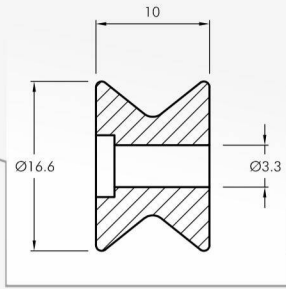



EK.02.330

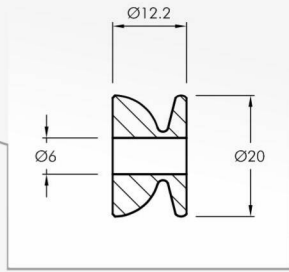

EK.02.331

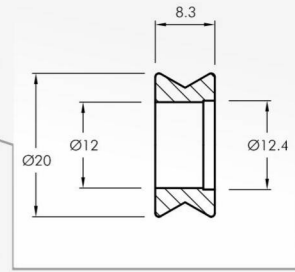

EK.02.332

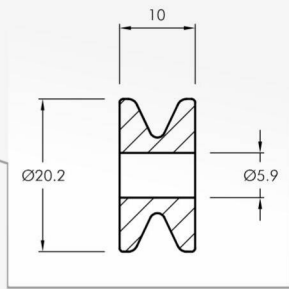

EK.02.333

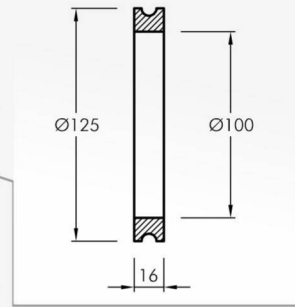

EK.02.334

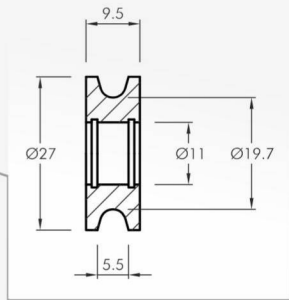

EK.02.335

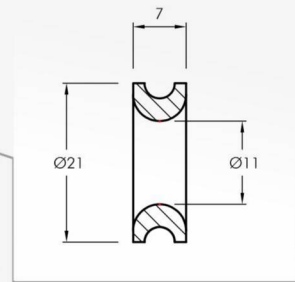

EK.02.336

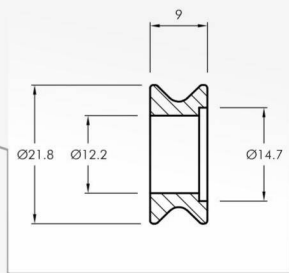

EK.02.337

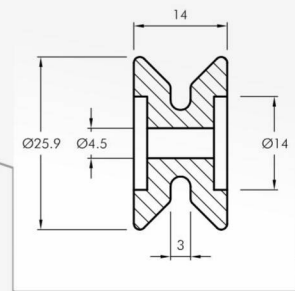

EK.02.338

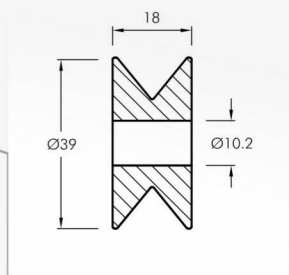

EK.02.339

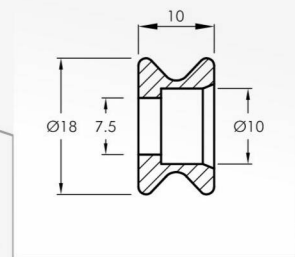

EK.02.340

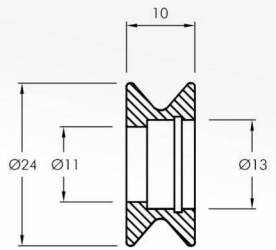
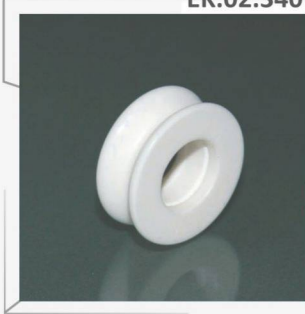

EK.02.341

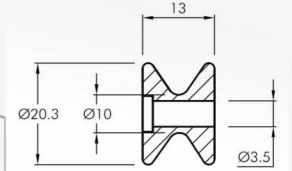

EK.02.342

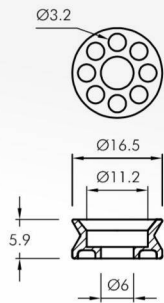
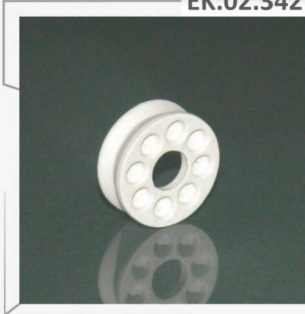

EK.02.344

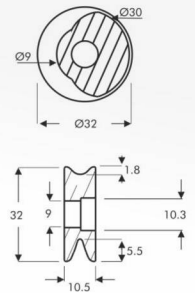

EK.02.345

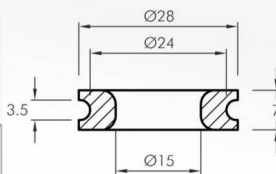
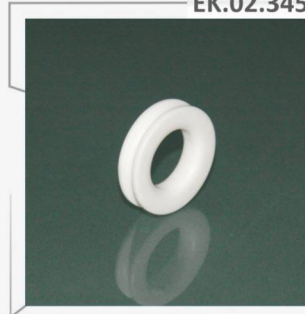

EK.02.346

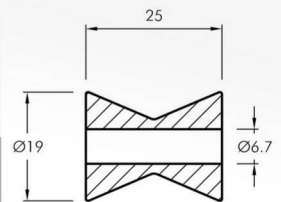

EK.02.347

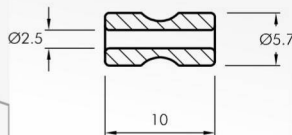

EK.02.348

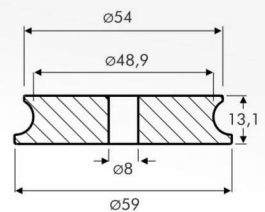

EK.02.349

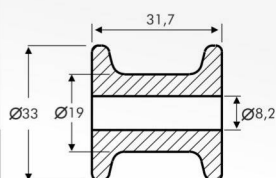

EK.02.350

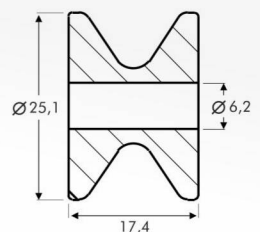

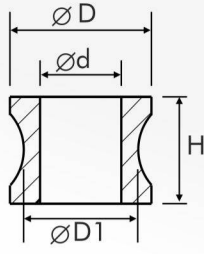
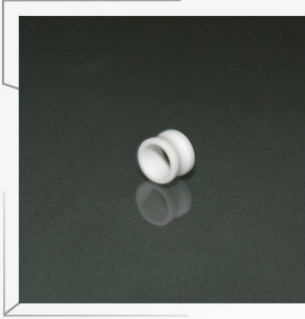

KOD NO	ØD	ØD1	Ød	H	h
EK.02.110	9.1	7.7	4.7	4.9	1.3
EK.02.111	6.8	6.1	3.4	7.2	4.5
EK.02.112	9	7.3	4.7	8.4	4.6

KOD NO	ØD	ØD1	Ød	H	h
EK.02.162	7.8	6.3	4.7	5.2	2.4
EK.02.186	8.9	7.4	4.5	4.4	1.5
EK.02.195	10.2	7.1	5.3	5.2	2.1

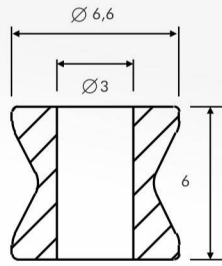
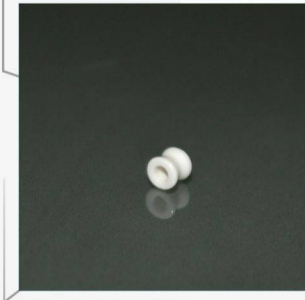
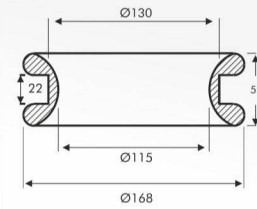
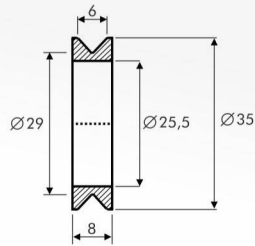
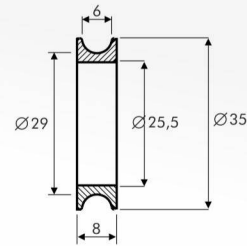
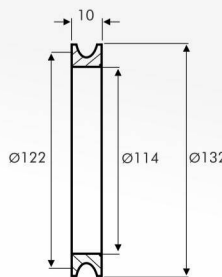
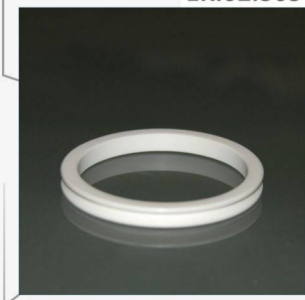
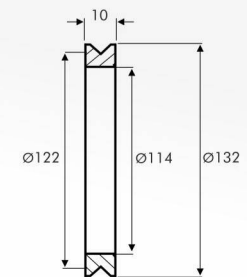
EK.02.354

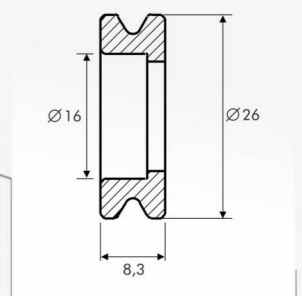
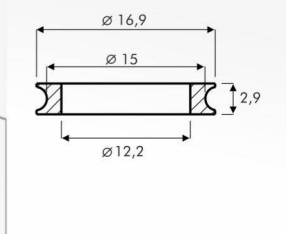
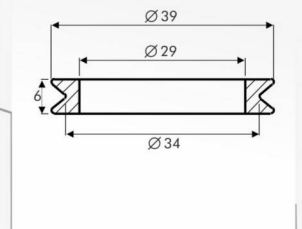
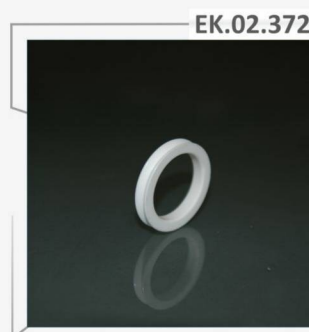
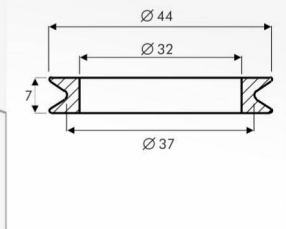
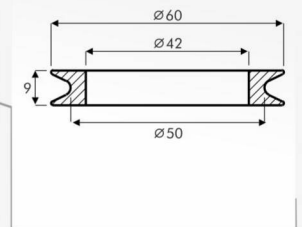
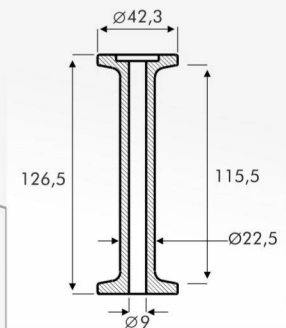
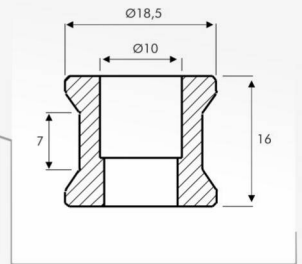
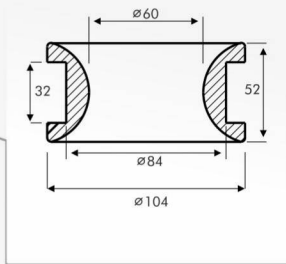
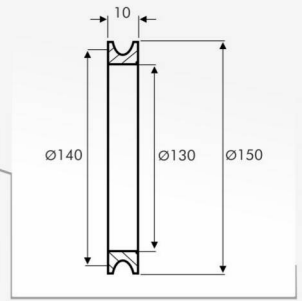
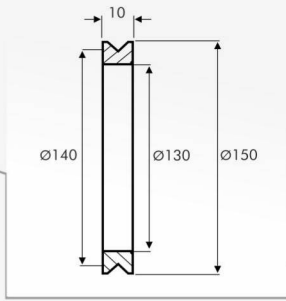
EK.02.356

EK.02.361

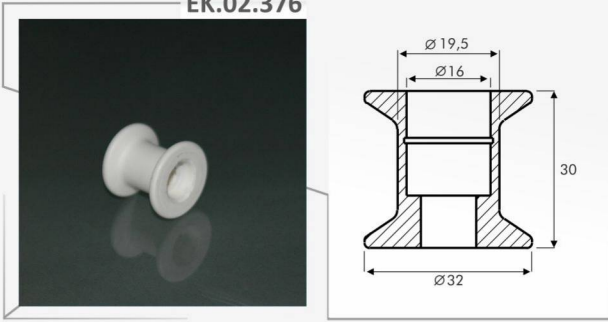
EK.02.362

EK.02.363

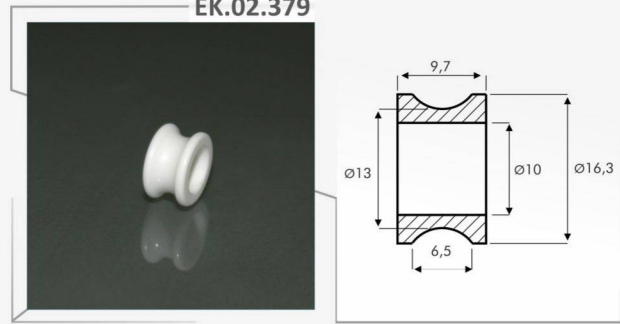
EK.02.364



EK.02.376



EK.02.379



EK.02.380

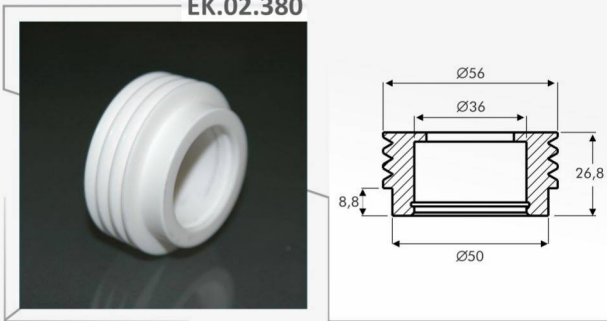

EK.02.381

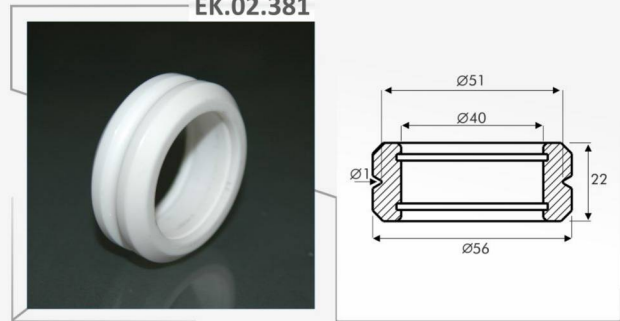

EK.02.382

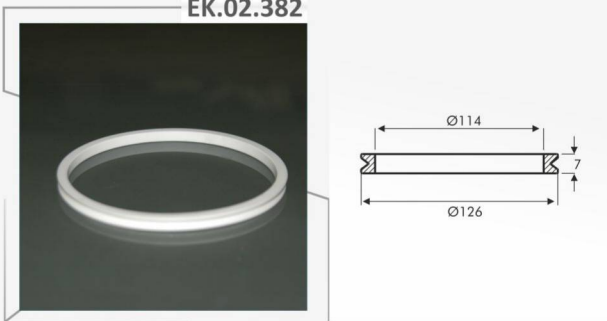

EK.02.383



EK.02.385

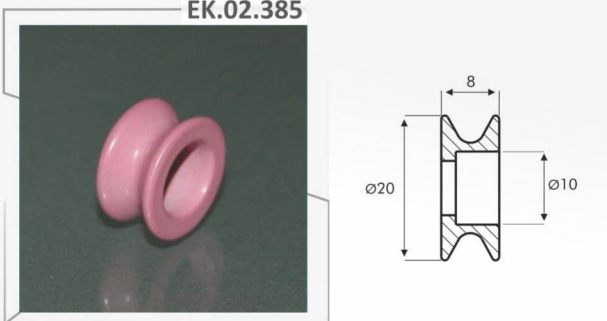

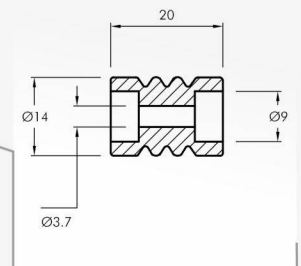
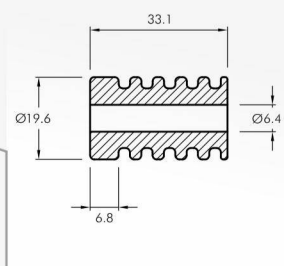
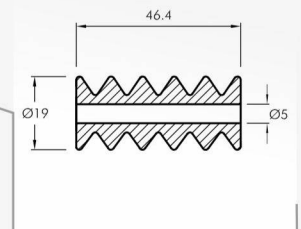
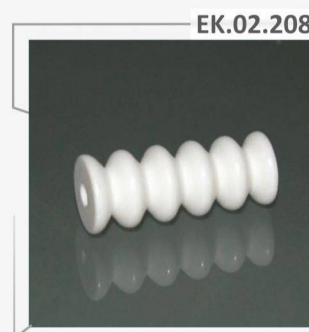
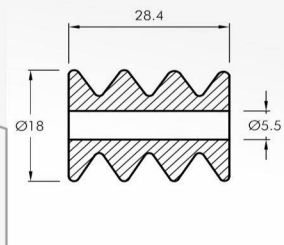
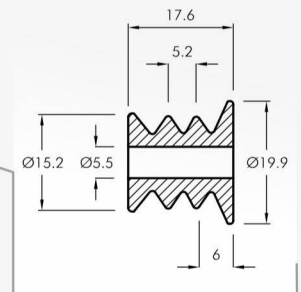
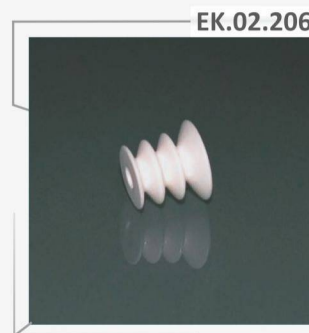
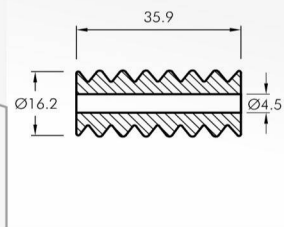
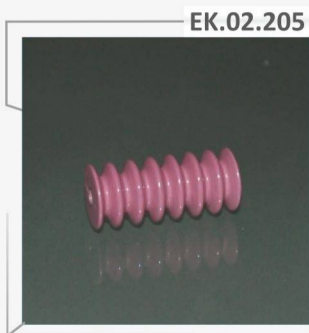
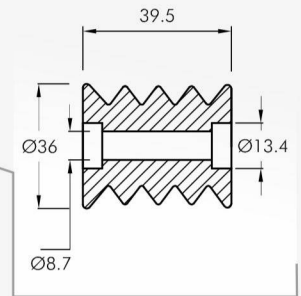
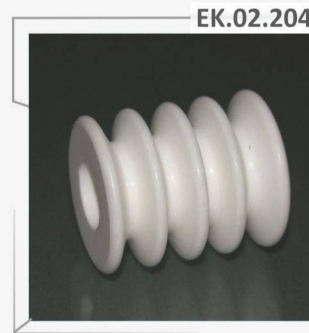
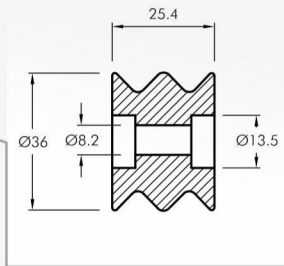
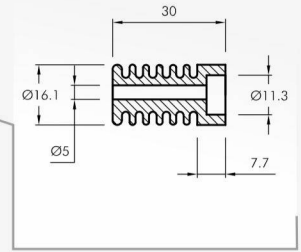
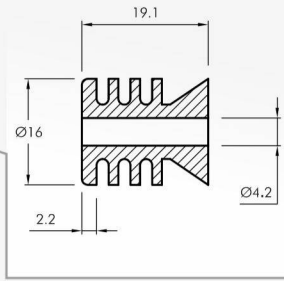



EK.02.211

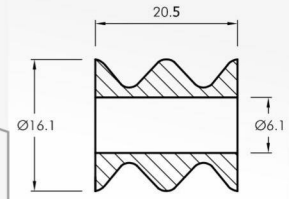
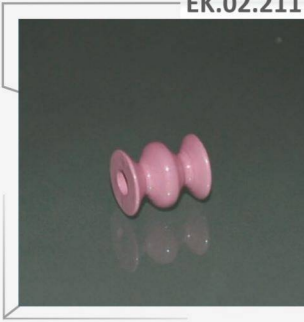

EK.02.212

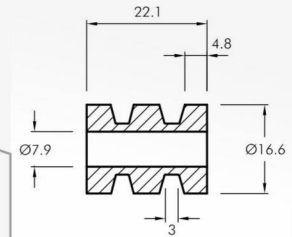
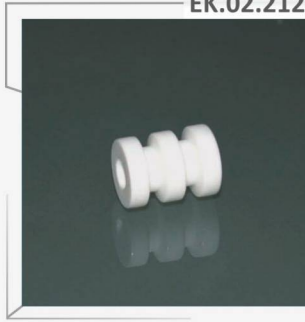

EK.02.213

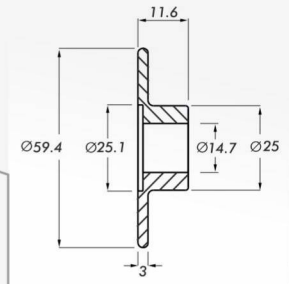
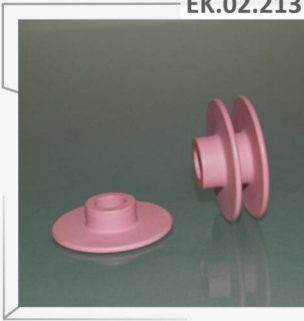

EK.02.214

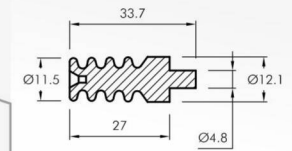
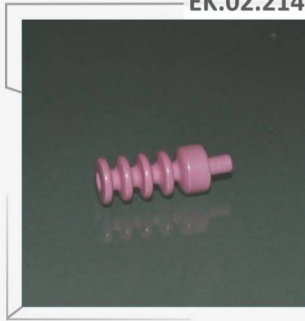

EK.01.215

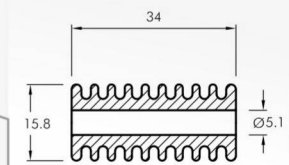
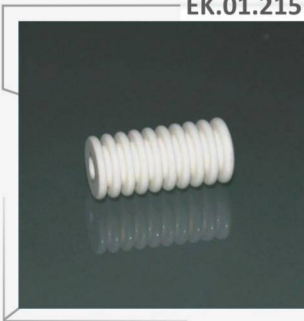

EK.02.216

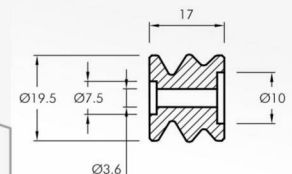

EK.02.217

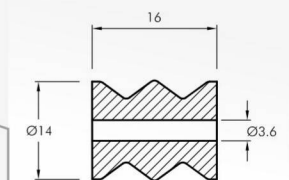

EK.02.218

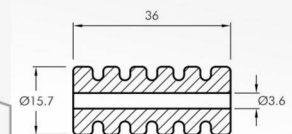

EK.02.219

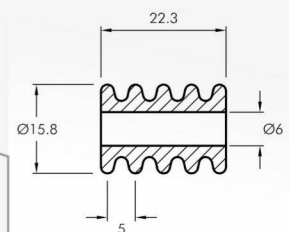
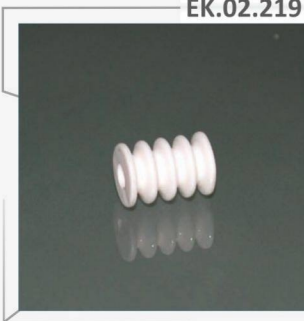

EK.02.220

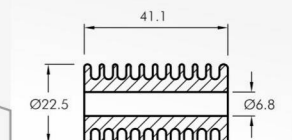
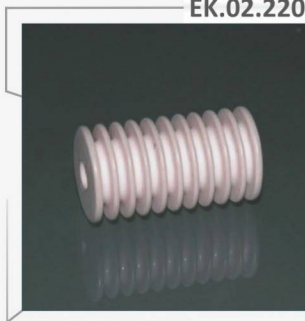

EK.02.221

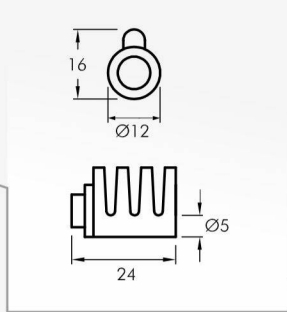
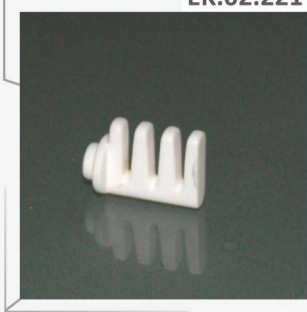

EK.02.222

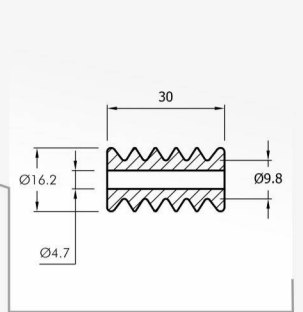
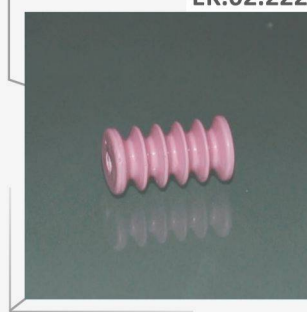

EK.02.223

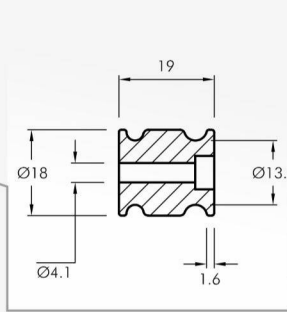
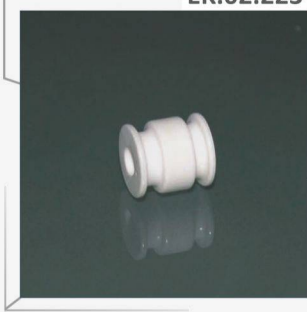

EK.02.224

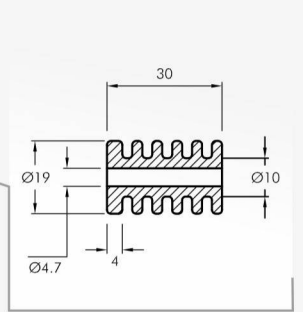
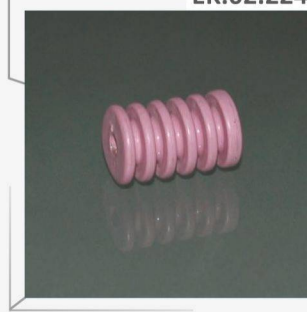

EK.02.225

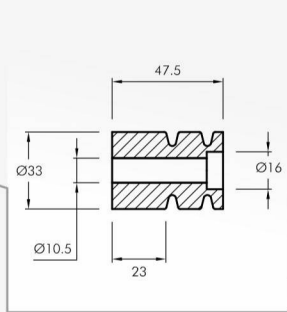

EK.02.226

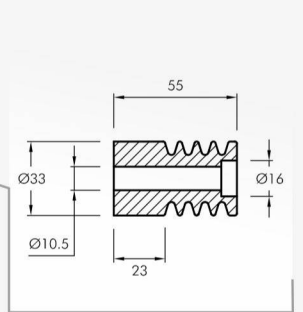
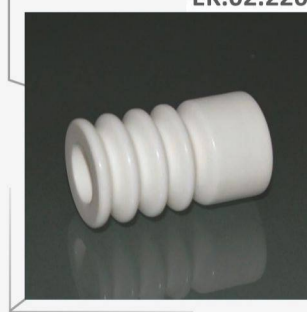

EK.02.227

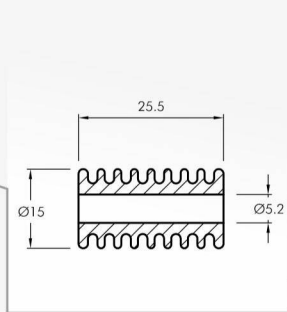
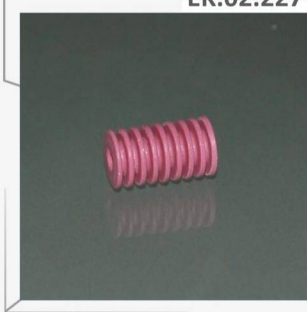

EK.02.228

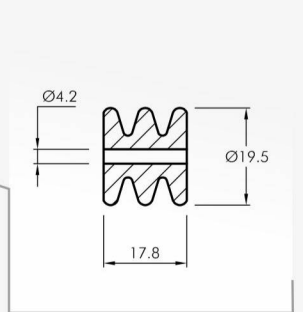
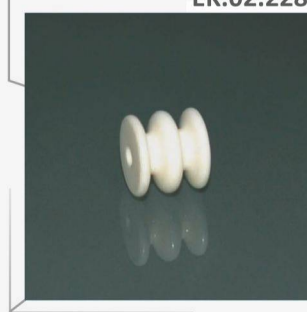

EK.02.229

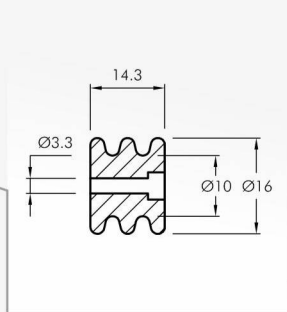
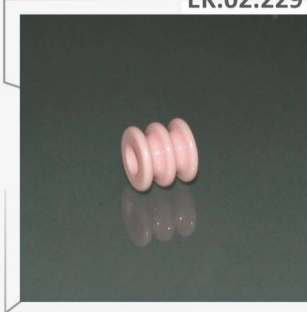

EK.02.230

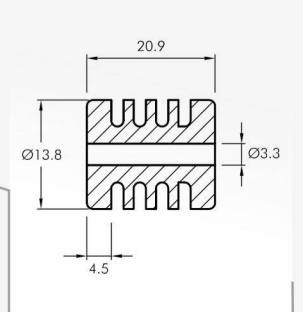
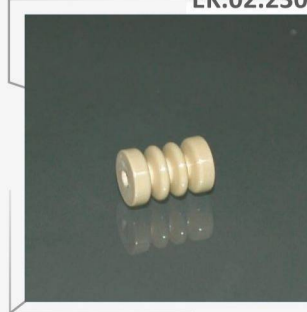



EK.02.231

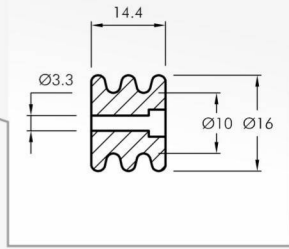

EK.02.232

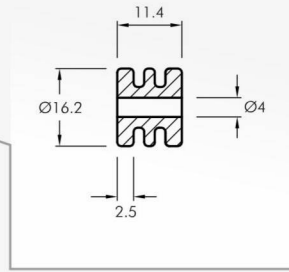
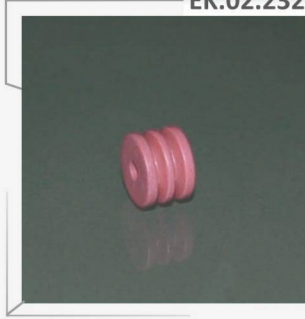

EK.02.233

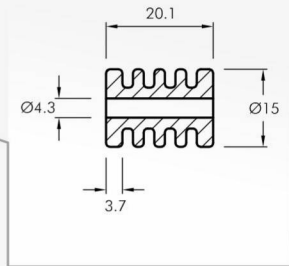
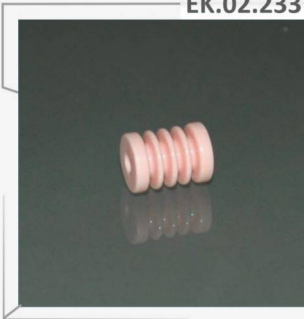

EK.02.234

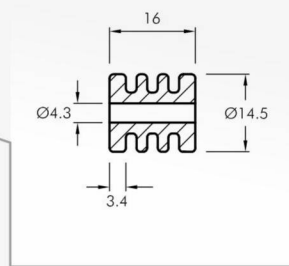

EK.02.235

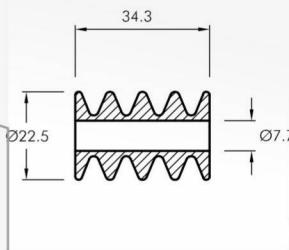
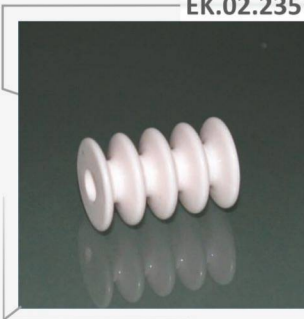

EK.02.236

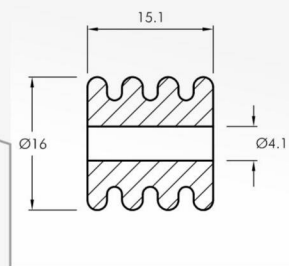
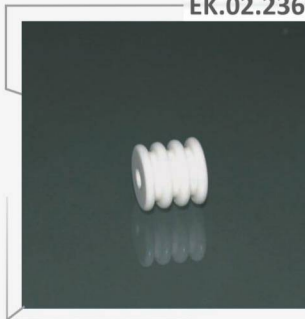

EK.02.237

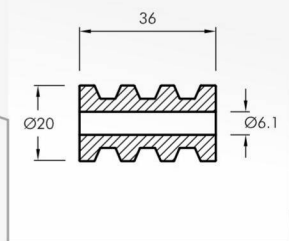
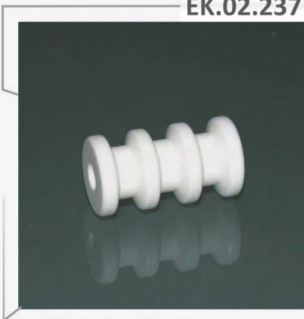

EK.02.238

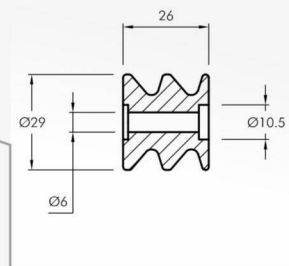

EK.02.239

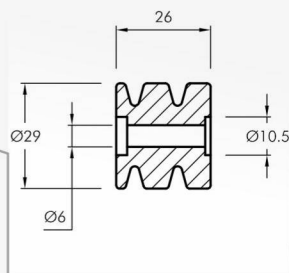

EK.02.241

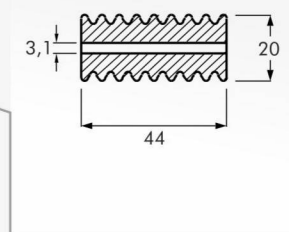
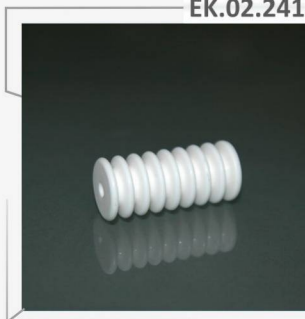

EK.02.242

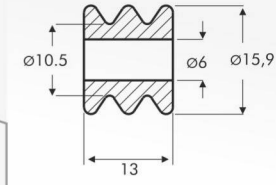
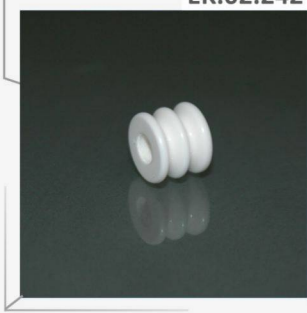

EK.02.243

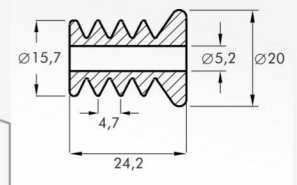

EK.02.244

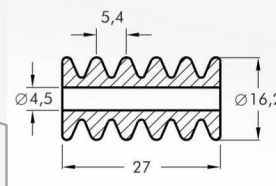
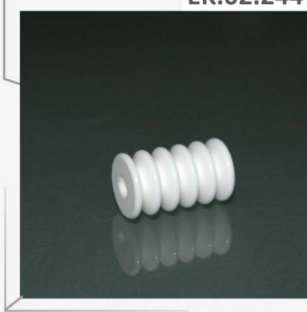

EK.02.245

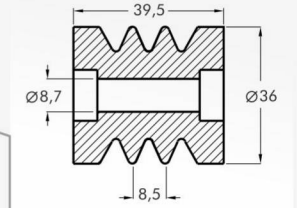
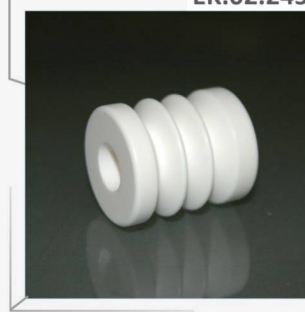

EK.02.246

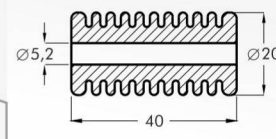
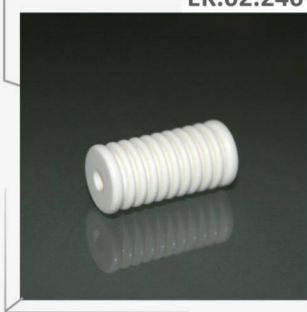

EK.02.248

